

RICOH

SLR Digital Camera

PENTAX *K-70*

Operating Manual

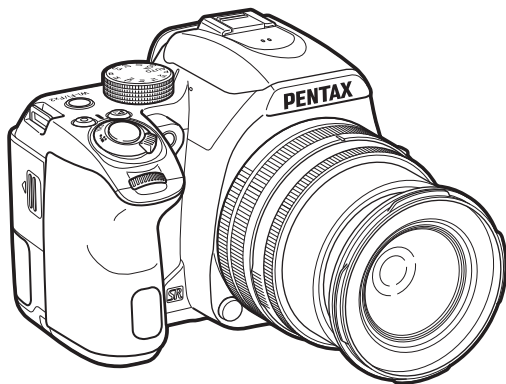

Introduction **1**

Getting Started **2**

Shooting **3**

Playback **4**

Sharing **5**

Settings **6**

Appendix **7**

To ensure the best performance from your camera, please read the Operating Manual before using the camera.

For Using Your Camera Safely

We have paid close attention to the safety of this camera. When using this camera, we request your special attention regarding items marked with the following symbols.



Warning

This symbol indicates that ignoring this item could cause serious personal injuries.



Caution

This symbol indicates that ignoring this item could cause minor or medium personal injuries, or loss of property.

About the Camera



Warning

- Do not disassemble or modify the camera. High voltage areas are present inside the camera, with the risk of electric shock.
- If the camera interior is exposed due to dropping or otherwise damaging the camera, never touch the exposed portion. There is a risk of electric shock.
- Do not aim the camera at the sun or other strong light sources when taking pictures or leave the camera sitting in direct sunlight with a lens cap off. Doing so may cause the camera to malfunction or cause a fire.
- Do not look at the sun or other strong light sources through a lens. Doing so may lead to a loss of eyesight or cause vision to be impaired.
- If any irregularities occur during use, such as smoke or a strange odor, stop using the camera immediately, remove the battery or the AC adapter, and contact your nearest service center. Continued use can cause a fire or electric shock.



Caution

- Do not place your finger over the flash when discharging the flash. You may burn yourself.
- Do not cover the flash with clothing when discharging the flash. Discoloration may occur.
- Some portions of the camera heat up during use. There is a risk of low temperature burns when holding such portions for long periods.

- Should the monitor be damaged, be careful of glass fragments. Also, be careful not to allow the liquid crystal to get on your skin or in your eyes or mouth.
- Depending on your individual factors or physical condition, the use of the camera may cause itching, rashes or blisters. In case of any abnormality, stop using the camera and get medical attention immediately.

About the Battery Charger and AC Adapter



Warning

- Always use the battery charger and AC adapter exclusively developed for this camera, with the specified power and voltage. Using a battery charger or AC adapter not exclusive to this camera, or using the exclusive battery charger or AC adapter with an unspecified power or voltage can cause a fire, electric shock, or camera breakdown. The specified voltage is 100 - 240V AC.
- Do not disassemble or modify the product. This can cause a fire or electric shock.
- If the generation of smoke or strange odor from the product or other abnormality occurs, immediately discontinue using and consult your nearest service center. Continued use can cause a fire or electric shock.
- If water should happen to get inside the product, consult your nearest service center. Continued use can cause a fire or electric shock.
- If you see a lightning flash or hear thunder during use of the battery charger or AC adapter, unplug the power plug and discontinue using. Continued use can cause damage to the product, fire or electric shock.
- Wipe off the power plug if it should become covered with dust. Accumulated dust may cause a fire.
- To reduce the risk of hazards, use only CSA/UL certified power supply cord set, cord is Type SPT-2 or heavier, minimum NO.18 AWG copper, one end with a molded-on male attachment plug cap (with a specified NEMA configuration), and the other is provided with a molded-on female connector body (with a specified IEC nonindustrial type configuration) or the equivalent.



Caution

- Do not place or drop heavy objects on or forcefully bend the AC plug cord. Doing so may damage the cord. Should the AC plug cord be damaged, consult your nearest service center.

- Do not touch or short-circuit the terminal area of the AC plug cord while the cord is plugged in.
- Do not handle the power plug with wet hands. This can cause an electric shock.
- Do not drop the product, or subject it to violent impact. This can cause the product to breakdown.
- Do not use the battery charger D-BC109 to charge batteries other than the rechargeable lithium-ion battery D-LI109. Attempting to charge other types of batteries may cause an explosion or heating, or may damage the battery charger.

About the Rechargeable Lithium-ion Battery

Warning

- If any leakage from the battery should come in contact with your eyes, do not rub them. Flush your eyes with clean water and get medical attention immediately.

Caution

- Only use the specified battery with this camera. Use of other batteries may cause an explosion or fire.
- Do not disassemble the battery. Disassembling the battery may cause an explosion or leakage.
- Remove the battery from the camera immediately if it becomes hot or begins to smoke. Be careful not to burn yourself during removal.
- Keep wires, hairpins, and other metal objects away from the + and - contacts of the battery.
- Do not short the battery or dispose of the battery in fire. This can cause an explosion or fire.
- If any leakage from the battery should come in contact with skin or clothing, it may cause irritation to the skin. Wash the affected areas thoroughly with water.
- Precautions for D-LI109 Battery Usage:
 - USE SPECIFIED CHARGER ONLY.
 - DO NOT INCINERATE.
 - DO NOT DISASSEMBLE.
 - DO NOT SHORT CIRCUIT.
 - DO NOT EXPOSE TO HIGH TEMP. (140°F / 60°C)

Keep the Camera and its Accessories out of the Reach of Small Children

Warning

- Do not place the camera and its accessories within the reach of small children.
 1. If the product falls or is operated accidentally, it may cause serious personal injuries.
 2. Wrapping the strap around a neck may cause suffocation.
 3. To avoid the risk of a small accessory such as the battery or memory cards from being swallowed by mistake, keep them out of the reach of small children. Seek medical attention immediately if an accessory is accidentally swallowed.

Checking the Contents of the Package



Hot shoe cover Fk
(Installed on camera)



Eyecup Fr
(Installed on camera)

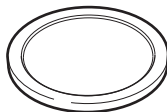

Body mount cover
(Installed on camera)

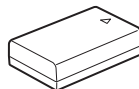

Rechargeable lithium-ion
battery D-L1109

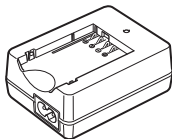

Battery charger
D-BC109



AC plug cord

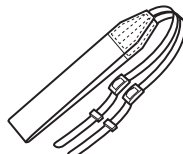

Strap
O-ST132

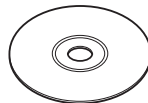

Software (CD-ROM)
S-SW168



Start Guide

Lenses you can use

Lenses that can be used with this camera are DA, DA L, D FA, FA J, and FA lenses and lenses that have an **A** (Auto) position on the aperture ring. To use any other lens or accessory, see p.121.

Introducing the K-70

1

Getting Started

2

Taking Pictures

3

Playback Functions

4

Sharing Images

5

Changing the Settings

6

Appendix

7

How to Use This Manual

1

Introducing the K-70p.9

Gives you an overview of the K-70.
Read this and get to know your K-70!

- Names and Functions of the Working Parts** p.9
- Display Indicators** p.12
- How to Change Function Settings** p.20
- Menu List** p.24

2

Getting Started.....p.36

Explains how to get your K-70 ready for shooting as well as basic operations.

- Attaching the Strap** p.36
- Attaching a Lens** p.36
- Using the Battery and Charger** p.37
- Inserting a Memory Card** p.40
- How to Open the Monitor** p.41
- Initial Settings** p.42

- Basic Shooting Operation** p.45
- Reviewing Images** p.47

3

Taking Pictures.....p.49

Once you've confirmed that the camera works properly, try out the camera and take lots of pictures!

- Configuring the Capture Settings** p.49
- Taking Still Pictures** p.50
- Recording Movies** p.54
- Setting the Exposure** p.56
- Using the Built-in Flash** p.59
- Setting the Focus Method** p.61
- Setting the Drive Mode** p.65
- Setting the White Balance** p.72
- Controlling the Image Finishing Tone** p.75
- Correcting Images** p.78

4

Playback Functionsp.83

Explains various operations for playing back and editing images.

- Playback Mode Palette Items**p.83
- Changing the Playback Method**p.84
- Editing and Processing Images**p.88

5

Sharing Images.....p.94

Explains how to connect your K-70 to a computer or communication device to operate the camera and use images in the camera.

- Copying an Image to a Computer**p.94
- Using the Camera with a Communication Device**p.95

6

Changing the Settingsp.106

Explains how to change other settings.

- Camera Settings**p.106
- File Management Settings**p.114

7

Appendix.....p.118

Provides other resources to get the most from your K-70.

- Restrictions on Each Capture Mode**p.118
- Functions Available with Various Lenses**p.121
- Functions when Using an External Flash**p.125
- Using the GPS Unit**p.126
- Troubleshooting**p.129
- Main Specifications**p.133
- Index**p.140
- Care to be Taken During Handling**p.145
- WARRANTY POLICY**p.149

There is a possibility that the illustrations and the display screen of the monitor in this manual are different from the actual ones.

Contents

Checking the Contents of the Package	2
How to Use This Manual	4
Introducing the K-70	9
Names and Functions of the Working Parts	9
Operating Controls	10
Display Indicators	12
Monitor	12
Viewfinder	18
Electronic Level	19
How to Change Function Settings	20
Using the Direct Keys	20
Using the Control Panel	20
Using the Menus	22
Menu List	24
Rec. Mode Menus	24
Movie Menus	29
Playback Menu	30
Set-up Menus	31
Custom Setting Menu	34
Getting Started	36
Attaching the Strap	36
Attaching a Lens	36
Using the Battery and Charger	37
Charging the Battery	37
Inserting/Removing the Battery	38
Using the AC Adapter	39
Inserting a Memory Card	40
How to Open the Monitor	41
Initial Settings	42
Turning the Camera On	42
Setting the Display Language	42
Setting the Date and Time	43
Setting the LCD Display	44
Formatting a Memory Card	44
Basic Shooting Operation	45
Shooting with the Viewfinder	45
Shooting while Viewing the Live View Image	47
Reviewing Images	47
Taking Pictures	49
Configuring the Capture Settings	49
Image Capture Settings	49
Movie Capture Settings	49
Taking Still Pictures	50
Scene Modes	50
Exposure Modes	51
Recording Movies	54
Playing Back Movies	56
Setting the Exposure	56
Sensitivity	56
EV Compensation	58
AE Metering	58
Using the Built-in Flash	59

Setting the Focus Method	61	Displaying Rotated Images	86
Setting the Autofocus when Shooting with the Viewfinder	61	Connecting the Camera to an AV Device	87
Setting the Autofocus when Shooting with Live View	63	Editing and Processing Images	88
AF Fine Adjustment	65	Changing the Image Size	88
Setting the Drive Mode	65	Correcting Color Moiré	89
Continuous Shooting	66	Processing Images with Digital Filters	89
Self-timer	67	Editing Movies	91
Remote Control	67	Developing RAW Images	92
Bracketing	68	Sharing Images	94
Mirror Lock-up Shooting	69	Copying an Image to a Computer	94
Multi-exposure	70	Using the Camera with a Communication Device	95
Interval Shooting	71	Enabling the Wi-Fi Function	95
Setting the White Balance	72	Operating the Camera with a Communication Device	97
Adjusting the White Balance Manually	74	Changing the Settings	106
Adjusting the White Balance with Color Temperature	75	Camera Settings	106
Controlling the Image Finishing Tone	75	Customizing the Button/E-dial Functions	106
Custom Image	75	Setting the Monitor and Indicator Lamps	110
Digital Filter	77	Saving Frequently Used Settings	111
Correcting Images	78	Displaying the Local Date and Time of the Specified City	113
Brightness Adjustment	78	Selecting Settings to Save in the Camera	113
Lens Correction	80	File Management Settings	114
Quality Level and Texture Adjustment	80	Protecting Images from Deletion (Protect)	114
Playback Functions	83	Selecting the Folder/File Settings	115
Playback Mode Palette Items	83	Setting the Copyright Information	117
Changing the Playback Method	84		
Displaying Multiple Images	84		
Displaying Images by Folder	85		
Displaying Images by Shooting Date	85		
Playing Back Images Continuously (Slideshow)	86		

Appendix.....	118
Restrictions on Each Capture Mode	118
Restrictions on the Combinations of Special Functions	120
Functions Available with Various Lenses	121
Using the Aperture Ring	123
Performing Catch-in Focus Shooting	124
Setting the Focal Length	125
Functions when Using an External Flash	125
Using the GPS Unit	126
Shooting Celestial Bodies (ASTROTRACER)	127
Troubleshooting	129
Sensor Cleaning	130
Error Messages	131
Main Specifications	133
Operating Environment for USB Connection and Provided Software	139
Index	140
Care to be Taken During Handling	145
WARRANTY POLICY	149

Regarding copyrights

Images taken with this camera that are for anything other than personal enjoyment cannot be used without permission according to the rights as specified in the Copyright Act. Please take care, as there are cases where limitations are placed on taking pictures even for personal enjoyment during demonstrations, performances or of items on display. Images taken with the purpose of obtaining copyrights also cannot be used outside the scope of use of the copyright as laid out in the Copyright Act, and care should be taken here also.

To users of this camera

- Do not use or store this camera in the vicinity of equipment that generates strong electromagnetic radiation or magnetic fields. Strong static charges or the magnetic fields produced by equipment such as radio transmitters could interfere with the monitor, damage the stored data, or affect the camera's internal circuitry and cause camera misoperation.
- The liquid crystal panel used for the monitor is manufactured using extremely high precision technology. Although the level of functioning pixels is 99.99% or better, you should be aware that 0.01% or fewer of the pixels may not light up or may light up when they should not. However, this has no effect on the recorded image.
- In this manual, the generic term "computer(s)" refers to either a Windows PC or a Macintosh.
- In this manual, the term "battery(ies)" refers to any type of batteries used for this camera and its accessories.

Regarding User Registration

In order to better serve you, we request that you complete the user registration, which can be found on the CD-ROM supplied with the camera or on our website. Thank you for your cooperation.





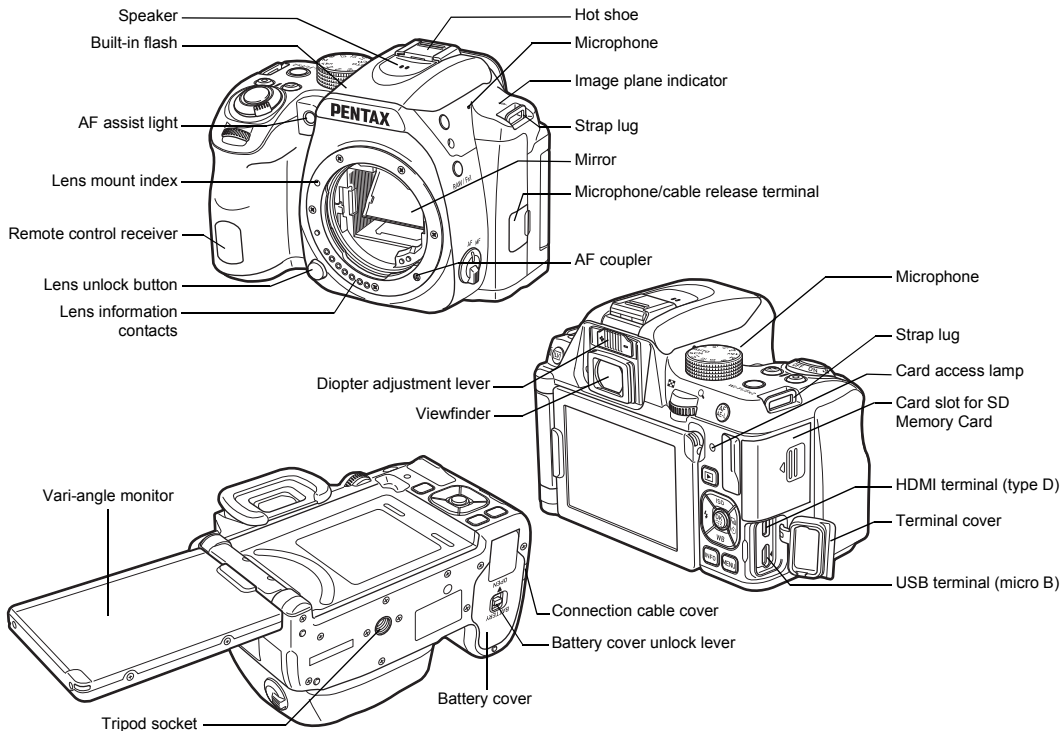



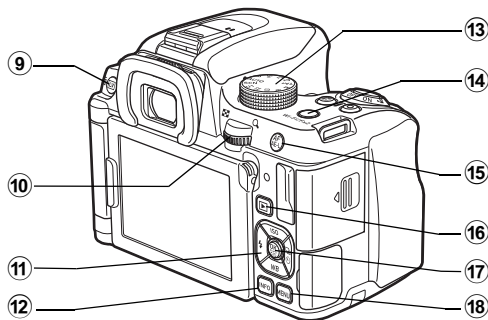
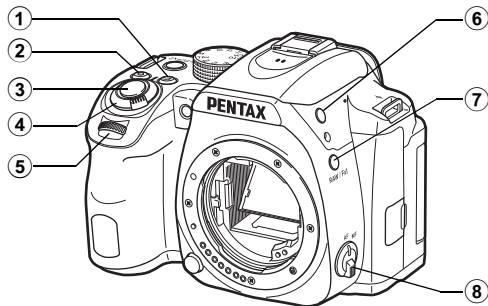

<http://www.ricoh-imaging.com/registration/>

Names and Functions of the Working Parts



Operating Controls



- ① **EV Compensation button** ()
Press to change the exposure compensation value. (p.58)
In playback mode, press to save the last JPEG image taken also in RAW format. (p.48)
- ② **Green button** ()
Resets the value being adjusted.
- ③ **Shutter release button** ()
Press to capture images. (p.46)
In playback mode, press halfway to switch to capture mode.
- ④ **Main switch**
Turns the power on or off, or switches to  (movie) mode. (p.42, p.54)
When the camera is turned on, it enters  (still picture) mode and the indicator lamp lights green. When the switch is turned to , the camera enters  mode and the lamp lights red.
- ⑤ **Front e-dial** ()
Changes the values for camera settings such as exposure. (p.52)
You can change the menu category when a menu screen is displayed. (p.22)
In playback mode, use this to select a different image.
- ⑥ **Flash pop-up button** ()
Press to pop up the built-in flash. (p.59)
- ⑦ **RAW/Fx1 button** ()
You can assign a function to this button. (p.106)
By default, the function that temporarily changes the file format (One Push File Format) is assigned.
- ⑧ **Focus mode switch**
Changes the focus method. (p.61)

- 9 Live View/Delete button (LV/📷)**
Displays the Live View image. (p.47)
In playback mode, press to delete images. (p.48)
- 10 Rear e-dial (🌀)**
Changes the values for camera settings such as exposure. (p.52)
You can change the menu tabs when a menu screen is displayed. (p.22)
You can change camera settings when the control panel is displayed. (p.20)
In playback mode, use this to magnify the image or display multiple images at the same time. (p.48, p.84)
- 11 Four-way controller (▲▼◀▶)**
Displays the Sensitivity, White Balance, Flash Mode or Drive Mode setup menu. (p.20)
When a menu or the control panel is displayed, use this to move the cursor or change the item to set.
Press ▼ in single image display of the playback mode to display the playback mode palette. (p.83)
- 12 INFO button (INFO)**
Changes the style of the display on the monitor. (p.12, p.16)
- 13 Mode dial**
Changes the capture mode. (p.45, p.50)
- 14 Wi-Fi/Fx2 button (Wi-Fi)**
You can assign a function to this button. (p.106)
In playback mode, press to turn the Wi-Fi function on or off. (p.96)
- 15 AF/AE Lock button (AF/AE-L)**
Available for adjusting focus, instead of pressing **SHUTTER** halfway, and for locking the exposure value before shooting. (p.53, p.61)

- 16 Playback button (📷)**
Switches to playback mode. (p.47) Press the button again to switch to capture mode.
- 17 OK button (OK)**
When a menu or the control panel is displayed, press this button to confirm the selected item.
Press and hold this button when [AF Active Area] is set to **AREA** or **SELEX**, or to **AMP** or **MDM** to switch the function of the arrow keys to the AF area change mode or the direct key operation mode. (p.62, p.64)
- 18 MENU button (MENU)**
Displays a menu. Press this button while the menu is displayed to return to the previous screen. (p.22)

About the Main Switch Lamp

The main switch lamp turns off in the following situations.

- From the time when **SHUTTER** is pressed halfway until the end of shooting
- During Interval Shooting
- During Optical Preview
- During playback mode
- While a menu is displayed
- During Auto Power Off

You can set the lamp illumination setting in [Other Indicator Lamps] of [Indicator Lamps] in the **2** menu. (p.110)

About the Four-way Controller

In this manual, each button of the four-way controller is indicated as shown in the illustration on the right.

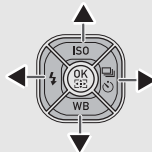

Display Indicators

Monitor

Capture Mode

With this camera, you can take pictures while looking through the viewfinder or while viewing the image on the monitor. When using the viewfinder, you can take pictures while checking the status screen displayed on the monitor and looking through the viewfinder. (p.45) When not using the viewfinder, you can take pictures while viewing the Live View image displayed on the monitor. (p.47)

The camera is in “standby mode” when it is ready to shoot, such as when the status screen or Live View image is displayed. Press **INFO** in standby mode to display the “control panel” and change settings. (p.20) You can change the type of information displayed in standby mode by pressing **INFO** while the control panel is displayed. (p.15)

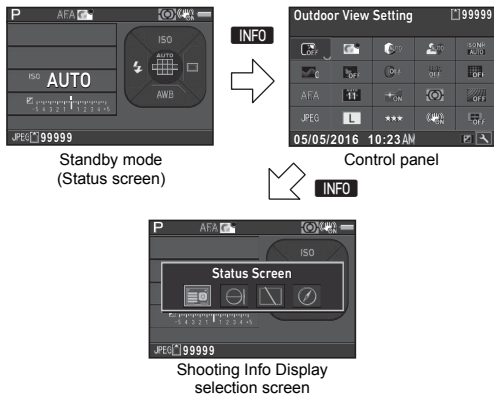

Memo

- You can set the display color of the status screen, control panel, and menu cursor in “Initial Settings” (p.42).

Status Screen

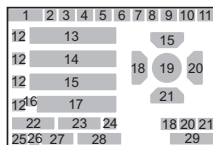
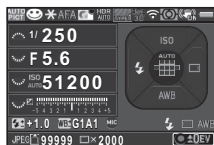

- | | |
|--|---|
| 1 Capture mode (p.50) | 16 EV Compensation (p.58)/Bracketing (p.68) |
| 2 AE Lock | 17 EV bar scale |
| 3 Focus Method (p.61) | 18 Flash Mode (p.59) |
| 4 Custom Image (p.75) | 19 Focusing area (AF point) (p.62) |
| 5 Clarity (p.80)/Skin Tone (p.80)/Digital Filter (p.77)/HDR Capture (p.79)/Pixel Shift Resolution (p.81) | 20 Drive Mode (p.65) |
| 6 AA Filter Simulator (p.81) | 21 White Balance (p.72) |
| 7 GPS positioning status (p.126) | 22 Flash Exposure Compensation (p.59) |
| 8 Wi-Fi connection status (p.95) | 23 White Balance fine-tuning (p.73) |
| 9 AE Metering (p.58) | 24 External Input Devices (p.55) |
| 10 Shake Reduction/ Horizon Correction | 25 File Format (p.49) |
| 11 Battery level | 26 Memory card |
| 12 E-dial guide | 27 Number of recordable still pictures/Movie recordable time |
| 13 Shutter speed | 28 Number of shots during Multi-exposure or Interval Shooting |
| 14 Aperture value | 29 Operation guide |
| 15 Sensitivity (p.56) | |

Live View

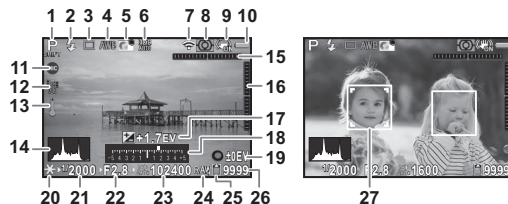

- | | |
|--|--|
| 1 Capture mode (p.50) | 15 Electronic Level (horizontal tilt) (p.19) |
| 2 Flash Mode (p.59) | 16 Electronic Level (vertical tilt) (p.19) |
| 3 Drive Mode (p.65) | 17 EV Compensation (p.58) |
| 4 White Balance (p.72) | 18 EV bar scale |
| 5 Custom Image (p.75) | 19 Operation guide, and number of shots during Multi-exposure or Interval Shooting |
| 6 Clarity (p.80)/Skin Tone (p.80)/Digital Filter (p.77)/HDR Capture (p.79)/Pixel Shift Resolution (p.81) | 20 AE Lock |
| 7 Wi-Fi connection status (p.95) | 21 Shutter speed |
| 8 AE Metering (p.58) | 22 Aperture value |
| 9 Shake Reduction/ Horizon Correction/ Movie SR | 23 Sensitivity (p.56) |
| 10 Battery level | 24 File Format (p.49) |
| 11 External Input Devices (p.55) | 25 Memory card |
| 12 GPS positioning status (p.126) | 26 Number of recordable still pictures/Movie recordable time |
| 13 Temperature warning | 27 Face detection frame (when [AF Active Area] is set to [Face Detection]) (p.63) |
| 14 Histogram | |

Memo

- In [Live View] of the 5 and 2 menus, you can change the display settings of Live View. (p.26, p.30)

Control Panel

The following functions are displayed with the default setting.

mode

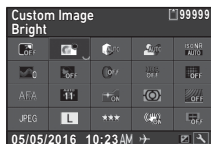

	1		3	4
	2			
5	6	7	8	9
10	11	12	13	14
15	16	17	18	19
20	21	22	23	24
	28		29	30

mode

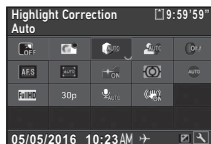

	1		3	4
	2			
5	6	7	8	12
15	16	17	18	25
21	26	27	23	
	28		29	30

- | | |
|---|--|
| <ol style="list-style-type: none"> 1 Function name 2 Setting 3 Memory card 4 Number of recordable still pictures/Movie recordable time 5 Outdoor View Setting (p.110) 6 Custom Image (p.75) 7 Highlight Correction (p.78) 8 Shadow Correction (p.78) 9 High-ISO NR (p.57) 10 Clarity (p.80) | <ol style="list-style-type: none"> 11 Skin Tone (p.80) 12 Digital Filter (p.77) 13 HDR Capture (p.79) 14 Pixel Shift Resolution (p.81) 15 AF Mode (p.62) 16 AF Active Area (p.62, p.64) 17 AF Assist Light (p.62) 18 AE Metering (p.58) 19 AA Filter Simulator (p.81) 20 File Format (p.49) 21 JPEG Recorded Pixels (p.49)/Movie Recorded Pixels (p.49) |
|---|--|

- 22 JPEG Quality (p.49)
- 23 Shake Reduction/Movie SR
- 24 Horizon Correction
- 25 External Input Devices (p.55)
- 26 Framerate (p.49)
- 27 Recording Sound Level (p.55)
- 28 Current date and time
- 29 Destination (p.113)
- 30 Operation guide for the control panel customization (p.21)

Memo



- Refer to “Using the Control Panel” (p.20) for how to use the control panel.
- The functions displayed on the control panel can be customized. (p.21)

Shooting Info Display

You can change the type of information displayed in standby mode by pressing **INFO** while the control panel is displayed. Use **◀▶** to select the type and press **OK**.

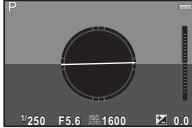

When shooting with the viewfinder

Status Screen	Displays the settings for shooting with the viewfinder. (p.13)
Electronic Level	<p>Displays the camera angle. A bar scale indicating the horizontal camera angle appears at the center of the screen, and a bar scale indicating the vertical camera angle appears on the right side. When the angle exceeds the range that can be displayed in each scale, the indicator segments of the scale are displayed in red.</p>  <p>Example: Tilted 1.5° to the left (yellow) Vertically level (green)</p>
Display Off	Nothing is displayed on the monitor.
Electronic Compass	<p>Displays the current latitude, longitude, altitude, direction, Coordinated Universal Time (UTC), capture mode, and exposure value. Turn the camera off and on again to return to the status screen. Available only when the optional GPS unit is attached to the camera and is operating. (p.126)</p> 

When shooting with Live View

Standard Information Display	The Live View image and the settings for shooting with Live View are displayed. (p.13)
Electronic Level	The same electronic level as when shooting with the viewfinder is displayed.
No Information Display	Certain icons, such as those for the capture mode and drive mode, are not displayed.

Memo

- The status screen is displayed when the camera is turned off and on again. If [Shooting Info Display] is set to (On) in [Memory] of the **5** menu, the screen selected on the Shooting Info Display selection screen appears when the camera is turned off and on again. (p.113)

Playback Mode

The captured image and shooting information are displayed in single image display of the playback mode.

Press **INFO** to change the type of information displayed in single image display. Use **◀▶** to select the type and press **OK**.



Single image display
(Standard Information Display)



Playback Info Display selection
screen

Standard Information Display	Captured image, file format, exposure parameters, and operation guide indicators are displayed.
Detailed Information Display	Detailed information on how and when the image was taken is displayed. (p.17)
Histogram Display	Captured image and brightness histogram are displayed. (p.18) Not available during movie playback.
RGB Histogram Display	Captured image and RGB histogram are displayed. (p.18) Not available during movie playback.
No Information Display	Only the captured image is displayed.

Memo

- You can set overexposed areas to blink red in Standard Information Display, Histogram Display, and No Information Display. Set in [Highlight Alert] of [LCD Display] in the **1** menu.
- The screen selected in the Playback Info Display selection screen is displayed in playback mode when the camera is turned off and on again. If [Playback Info Display] is set to (Off) in [Memory] of the **5** menu, the Standard Information Display always appears first when the camera is turned on. (p.113)

Detailed Information Display

Still pictures

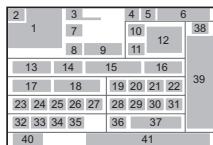

Movies

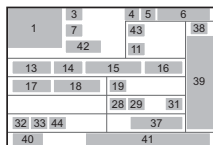

Page 2

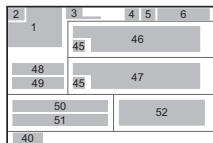

- 1 Captured image
- 2 Rotation information (p.86)
- 3 Capture mode (p.50)
- 4 Wi-Fi connection status (p.95)
- 5 Protect setting (p.114)

- 6 Folder number-File number (p.115)
- 7 Drive Mode (p.65)
- 8 Flash Mode (p.59)
- 9 Flash Exposure Compensation (p.59)
- 10 Focus Method (p.61)

- 11 AE Metering (p.58)
- 12 Focusing area (AF point) (p.62)
- 13 Shutter speed
- 14 Aperture value
- 15 Sensitivity (p.56)
- 16 EV Compensation (p.58)
- 17 White Balance (p.72)
- 18 White Balance fine-tuning (p.73)
- 19 Digital Filter (p.77)
- 20 HDR Capture (p.79)/ Pixel Shift Resolution (p.81)
- 21 Clarity (p.80)
- 22 Skin Tone (p.80)
- 23 Distortion Correction (p.80)
- 24 Peripheral Illumination Correction (p.80)
- 25 Lateral Chromatic Aberration Adjustment (p.80)
- 26 Diffraction Correction (p.80)
- 27 Color Fringe Correction (p.93)
- 28 Highlight Correction (p.78)
- 29 Shadow Correction (p.78)
- 30 AA Filter Simulator (p.81)
- 31 Shake Reduction/ Horizon Correction/ Movie SR
- 32 File Format (p.49)
- 33 JPEG Recorded Pixels (p.49)/Movie Recorded Pixels (p.49)
- 34 JPEG Quality (p.49)
- 35 Color Space (p.49)
- 36 Color Moiré Correction (p.89)
- 37 Lens focal length
- 38 Custom Image setting (p.75)
- 39 Custom Image parameters
- 40 Operation guide
- 41 Shooting date and time
- 42 Length of time of the recorded movie
- 43 Recording Sound Level (p.55)
- 44 Framerate (p.49)
- 45 Tampered image warning
- 46 Photographer (p.117)
- 47 Copyright Holder (p.117)
- 48 Altitude
- 49 Lens direction
- 50 Latitude
- 51 Longitude
- 52 Universal Coordinated Time

Histogram Display

Use ▲▼ to switch between the brightness histogram and RGB histogram.

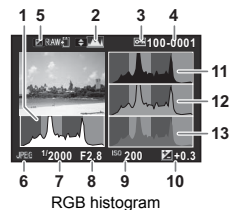
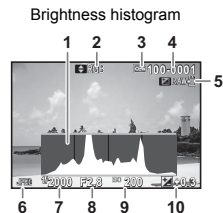

- 1 Histogram (Brightness)
- 2 RGB histogram/
Brightness histogram
- 3 Protect setting
- 4 Folder number-File
number
- 5 Save RAW Data
- 6 File Format
- 7 Shutter speed
- 8 Aperture value
- 9 Sensitivity
- 10 EV Compensation
- 11 Histogram (R)
- 12 Histogram (G)
- 13 Histogram (B)

Viewfinder

When shooting with the viewfinder, information appears in the viewfinder.

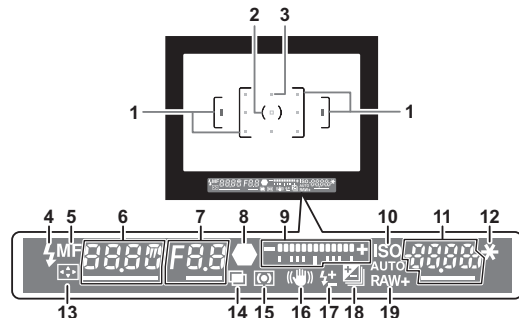

- 1 AF frame (p.46)
- 2 Spot metering frame
(p.58)
- 3 AF point (p.62)
- 4 Flash indicator (p.59)
- 5 Focus Method (p.61)
- 6 Shutter speed/Exposure
time for timed exposure
in **B** mode/Number of
shots for Bracketing
- 7 Aperture value/Bracket
value for Bracketing
- 8 Focus indicator (p.46)
- 9 EV bar scale/Electronic
Level (p.19)
- 10 ISO/ISO AUTO
- 11 Sensitivity (p.56)/
Exposure compensation
value
- 12 AE Lock
- 13 Change AF Area (p.62)
- 14 Multi-exposure (p.70)
- 15 AE Metering (p.58)
- 16 Shake Reduction
- 17 Flash Exposure
Compensation (p.59)
- 18 EV Compensation
(p.58)/Bracketing (p.68)
- 19 File Format (p.49)

Memo

- The information is displayed in the viewfinder when **SHUTTER** is pressed halfway, or during the meter operating time (default setting: 10 sec.).
- The AF point in use for autofocus appears in red (Superimpose AF Area) when **SHUTTER** is pressed halfway. You can turn this function off in [Superimpose AF Area] of [Viewfinder Overlay] in the **C5** menu. (p.26)
- You can adjust the viewfinder image sharpness using the diopter adjustment lever. If it is difficult to move the diopter adjustment lever, lift up and remove the eyecup. Adjust the diopter setting until the AF frame in the viewfinder looks sharp and clear.

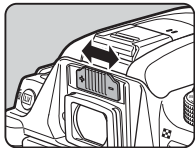

Electronic Level

You can check whether the camera is tilted by displaying electronic levels. The electronic level for the horizontal camera angle can be displayed in the viewfinder, and the electronic levels for the vertical and horizontal camera angles can be displayed on the Live View screen. (p.13)
Select whether to display the electronic levels in [Viewfinder Overlay] and [Live View] of the **C5** menu. (p.26)

Examples of Electronic Level in the Viewfinder

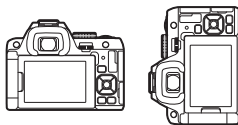

When level (at 0°)



When tilted 5° to the left



When held vertically and tilted 3° to the right



Memo

- When [Electronic Level] is assigned to **Fx1** or **Fx2** in [Button Customization] of the **C5** menu, you can turn the electronic level display on or off by a simple button operation. (p.106)

How to Change Function Settings

Using the Direct Keys

Press ▲▼◀▶ in standby mode.

▲	Sensitivity	p.56
▼	White Balance	p.72
◀	Flash Mode	p.59
▶	Drive Mode	p.65

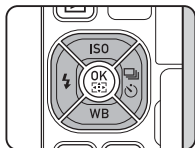

Using the Control Panel

Press **INFO** in standby mode.

Use ▲▼◀▶ to select an item.

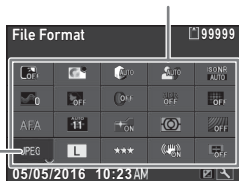

Use  to change settings.

Press **OK** to make detailed settings.

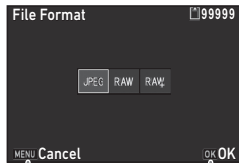

Press **MENU** to cancel the setting operation.

Press **OK** to confirm the selected item and return to the control panel.

Memo

- The functions that can be selected vary depending on the current camera setup.
- If no operations are made within approximately 1 minute while the control panel is displayed, the camera returns to standby mode.

Using the Menus





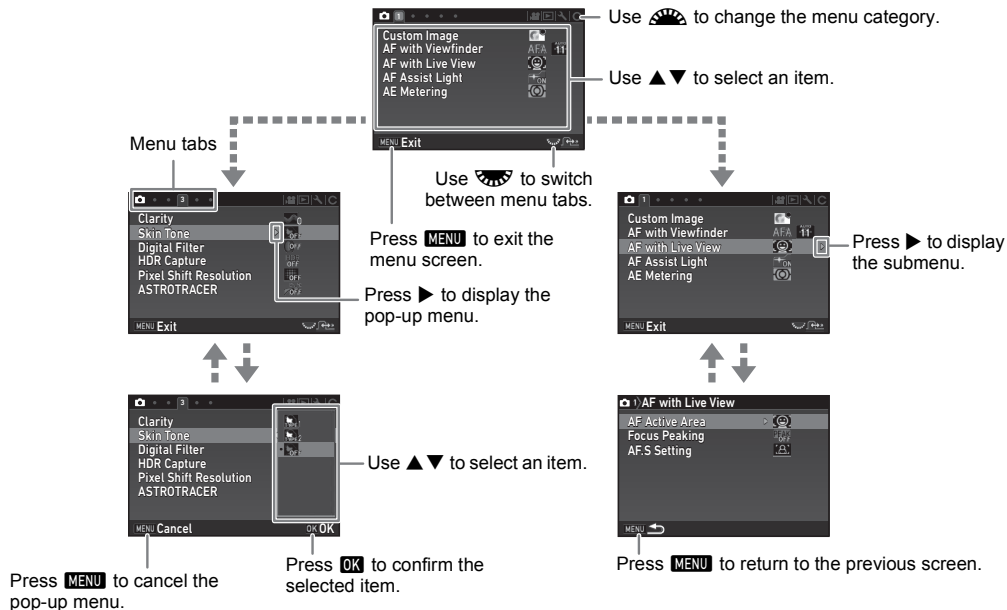

Most functions are set from the menus.

1

Introduction



Memo

- For the Custom Setting menus (**C** menus), you can show the setting screen of the next item in order of the menus on the monitor by turning  while the submenu of the currently selected item is displayed.
- Press **MENU** to display the first tab of the most appropriate menu for the camera settings at that time. To display the menu tab last selected first, set in [21 Save Menu Location] of the **C3** menu.
- The settings changed with the  menus,  menus,  menu,  menus, direct keys, control panel, and playback mode palette are returned to their default values with [Reset] of the 5 menu. To reset the settings in the Custom Setting menus to the defaults, use [Reset Custom Functions] of the **C4** menu. (Some settings do not apply.)

Menu List



1





Introduction

Rec. Mode Menus

Menu	Item	Function	Default Setting	Page	
	Custom Image *1 *2	Sets the image finishing tone such as color and contrast before shooting an image.	Bright	p.75	
	Scene Mode *1 *3	Selects the scene mode that best suits the situation. (SCN mode)	Portrait	p.50	
	AF with Viewfinder	AF Mode *1	Selects the AF mode for shooting with the viewfinder.	AF.A	p.62
		AF Active Area *1	Selects the area to adjust the focus for shooting with the viewfinder.	Auto (11 AF Points)	p.62
		AF.S Setting	Sets the action priority for when the autofocus mode is set to AF.S and SHUTTER is fully pressed.	Focus-priority	p.61
		1st Frame Action in AF.C	Sets the action priority for the first frame when the autofocus mode is set to AF.C and SHUTTER is fully pressed.	Auto	p.61
		Action in AF.C Cont.	Sets the action priority during Continuous Shooting when the autofocus mode is set to AF.C .	Auto	p.61
		Hold AF Status	Maintains the focus for a certain amount of time when the subject happens to move out of the selected focusing area after being focused.	Low	p.61
	AF with Live View	AF Active Area *1	Selects the area to adjust the focus for shooting with Live View.	Face Detection	p.63
		Focus Peaking *1	Emphasizes the outline of the subject in focus and makes it easier to check the focus.	Off	
		AF.S Setting	Sets the action priority for when SHUTTER is fully pressed.	Focus-priority	
	AF Assist Light *1	Discharges the assist light when autofocusing in dark locations.	On	p.62	

Menu	Item	Function	Default Setting	Page	
📷1	AE Metering *1	Selects the part of the sensor to use for measuring brightness and determining the exposure.	Multi-segment	p.58	
	Exposure Mode *4	Temporarily changes the exposure mode when the mode dial is set to one of the modes from U1 to U3 .	–	p.112	
📷2	Image Capture Settings	File Format *1	Sets the file format of images.	JPEG	p.49
		JPEG Recorded Pixels *1	Sets the recording size of JPEG images.		
		JPEG Quality *1	Sets the quality of JPEG images.	★★★	
		RAW File Format	Sets the RAW file format.	PEF	
		Color Space	Sets the color space to use.	sRGB	
	D-Range Settings	Highlight Correction *1	Expands the dynamic range and prevents overexposed areas from occurring.	Auto	p.78
		Shadow Correction *1	Expands the dynamic range and prevents underexposed areas from occurring.	Auto	
	Noise Reduction	Slow Shutter Speed NR *1	Sets the Noise Reduction setting when shooting with a slow shutter speed.	Auto	p.52
		High-ISO NR *1	Sets the Noise Reduction setting when shooting with a high ISO sensitivity.	Auto	p.57
	📷3	Clarity *1	Changes the clarity of images using an image processing program.	±0	p.80
Skin Tone *1		Enhances the skin tone of the subject in the image using an image processing program.	Off	p.80	
Digital Filter *1		Applies a digital filter effect when taking pictures.	No Filter	p.77	
HDR Capture *1		Sets the type of high dynamic range shooting.	Off, ±2EV, On	p.79	
Pixel Shift Resolution *1		Merges four images shifted pixel by pixel and outputs a high-definition image.	Off	p.81	
ASTROTRACER *1		Makes settings to track and capture celestial bodies.	Off	p.127	

Menu	Item	Function	Default Setting	Page	
	AA Filter Simulator *1	Applies a low-pass filter effect using the Shake Reduction mechanism.	Off	p.81	
	Shake Reduction *1	Activates the Shake Reduction function.	On	–	
	Horizon Correction *1	Corrects horizontal tilt when in  mode.	Off	–	
	Lens Correction	Distortion Correction *1	Reduces distortions occurring due to lens properties.	Off	p.80
		Peripheral Illumin. Corr. *1	Reduces peripheral light fall-off occurring due to lens properties.	Off	
		Lat-Chromatic-Ab Adj *1	Reduces lateral chromatic aberrations occurring due to lens properties.	On	
		Diffraction Correction *1	Corrects blur caused by diffraction when using a small aperture.	On	
Input Focal Length *1		Sets the focal length when using a lens of which focal length information cannot be obtained.	35mm	p.125	
	Viewfinder Overlay	Electronic Level *1	Displays the electronic level at the bottom of the viewfinder.	Off	p.19
		Superimpose AF Area	Displays the active AF point in red in the viewfinder.	On	p.19
	Live View	Grid Display *1	Sets the type and color of the grid lines displayed during Live View.	Off, Black	p.13
		Electronic Level *1	Displays the electronic level during Live View.	On	
		Histogram Display	Displays the histogram during Live View.	Off	
		Highlight Alert	Sets overexposed areas to blink red during Live View.	Off	
		Flicker Reduction	Cuts down on the Live View screen flicker by setting the power frequency.	50Hz	

Menu	Item		Function	Default Setting	Page	
5	Instant Review	Display Time	Sets the Instant Review display time.	1sec.	p.46	
		Zoom Review	Displays the magnified image during Instant Review.	On		
		Save RAW Data	Saves the RAW data during Instant Review.	On		
		Delete	Deletes the displayed image during Instant Review.	On		
		Histogram Display	Displays the histogram during Instant Review.	Off		
		Highlight Alert	Sets overexposed areas to blink red during Instant Review.	Off		
	Other Display Settings	Guide Display	Displays operation guides when the capture mode is changed.	On	p.45	
		Display Color	Sets the display color of the status screen, control panel, and menu cursor.	1	p.44	
	Button Customization	Fx1 Button	Sets the function for when Fx1 is pressed.	One Push File Format	p.106	
		Fx2 Button	Sets the function for when Fx2 is pressed.	Wi-Fi		
		AF/AE-L Button	Sets the function for when AF/AE-L is pressed.	Enable AF1		
		E-Dial Programming	P	Sets the  /  /  operation for each exposure mode.	Tv, Av, →P	p.109
			Sv		-, ISO, -	
			Tv		Tv , -, -	
			Av		-, Av , -	
TAv			Tv, Av, P LINE			
M	Tv, Av, P LINE					
Rotation Direction	Reverses the effect obtained when  or  is turned.	Rotate Right				

Menu	Item	Function	Default Setting	Page	
 5	Memory	Determines which settings to save when the power is turned off.	Sensitivity	On	p.113
			EV Compensation	On	
			Flash Mode	On	
			Flash Exposure Comp.	On	
			Drive Mode	On	
			White Balance	On	
			Custom Image	On	
			Clarity	Off	
			Skin Tone	Off	
			Digital Filter	Off	
			HDR Capture	Off	
			Pixel Shift Resolution	Off	
			Shooting Info Display	Off	
			Playback Info Display	On	
			Outdoor View Setting	Off	
Night Vision LCD Display	Off				
Save USER Mode	Save Settings	You can save frequently used capture settings to U1 to U3 of the mode dial.	CLEAR TONE, HDR LANDSCAPE, ASTROPHOTO	p.111	
	Rename USER Mode	Changes the names of the saved USER modes to display on the monitor.	CLEAR TONE, HDR LANDSCAPE, ASTROPHOTO		
	Check Saved Settings	Displays the settings saved in USER modes.	—		
	Reset USER Mode	Resets all the settings saved in USER modes to the defaults.	—		



*1 Available as a function in the control panel.









*2 The function appears in modes other than **SCN** mode.

*3 The function appears in **SCN** mode.

*4 The function appears only in **U1** to **U3** modes.

Movie Menus

Menu	Item	Function	Default Setting	Page	
 1	Custom Image *1	Sets the image finishing tone such as color and contrast before shooting an image.	Bright	p.75	
	AF with Live View	AF Mode	Selects the AF mode for movie recording.	AFS	p.63
		AF Active Area *1	Selects the area to adjust the focus for movie recording.	Multiple AF Points	
		Focus Peaking *1	Emphasizes the outline of the subject in focus and makes it easier to check the focus.	Off	
	AF Assist Light *1	Discharges the assist light when autofocusing in dark locations.	On	p.62	
	AE Metering *1	Selects the part of the sensor to use for measuring brightness and determining the exposure.	Multi-segment	p.58	
	Movie Capture Settings	Recorded Pixels *1	Sets the number of recorded pixels of the movie.		p.49
		Framerate *1	Sets the framerate of the movie.	30p	
Recording Sound Level *1		Sets the sound level for recording.	Auto	p.55	
 2	D-Range Settings	Highlight Correction *1	Expands the dynamic range and prevents overexposed areas from occurring.	Auto	p.78
		Shadow Correction *1	Expands the dynamic range and prevents underexposed areas from occurring.	Auto	
	Digital Filter *1		Applies a digital filter effect when recording a movie.	No Filter	p.77
	Movie SR *1		Activates the Shake Reduction function.	On	–

Menu	Item		Function	Default Setting	Page	
2	Live View	Grid Display *1	Sets the type and color of the grid lines displayed during Live View.	Off, Black	p.13	
		Electronic Level *1	Displays the electronic level during Live View.	On		
		Histogram Display	Displays the histogram during Live View.	Off		
		Highlight Alert	Sets overexposed areas to blink red during Live View.	Off		
		Flicker Reduction	Cuts down on the Live View screen flicker by setting the power frequency.	50Hz		
2	Button Customization	AF/AE-L Button	Sets the function for when AF/AE-L is pressed.	Enable AF1	p.106	
		E-Dial Programming		Sets the  /  /  operation for each exposure mode.	- , - , -	p.109
					- , Av , P LINE	
					Tv , Av , P LINE	
					Tv , Av , P LINE	
Rotation Direction	Reverses the effect obtained when  or  is turned.	Rotate Right				

*1 Available as a function in the control panel.

Playback Menu





Menu	Item		Function	Default Setting	Page
1	Slideshow	Display Duration	Sets an image display interval.	3sec.	p.86
		Screen Effect	Sets a transition effect when the next image is displayed.	Off	
		Repeat Playback	Starts a slideshow again from the beginning after the last image is displayed.	Off	
		Auto Movie Playback	Plays back movies during a slideshow.	On	
	Protect All Images		Protects all stored images at once.	-	p.114
	Delete All Images		Deletes all stored images at once.	-	-
	Quick Zoom		Sets the initial magnification when magnifying images.	Off	p.48

Menu	Item	Function	Default Setting	Page	
□1	Playback Sound Volume	Sets the sound volume during movie playback.	10	p.56	
	LCD Display	Auto Image Rotation	Rotates images which were captured with the camera held vertically or of which the rotation information has been changed.	On	p.86
		Grid Display	Sets the type and color of grid lines.	Off, Black	p.48
		Highlight Alert	Sets overexposed areas to blink red in Standard Information Display, Histogram Display, and No Information Display of the playback mode.	Off	p.16

Set-up Menus

Menu	Item	Function	Default Setting	Page	
↩1	Language/言語	Changes the display language.	English	p.42	
	Date Adjustment	Sets the date and time and the display format.	01/01/2016	p.43	
	World Time	Switches between the date and time display of your hometown city and that of a specified city.	Hometown	p.113	
	Text Size	Magnifies the text size when selecting a menu item.	Std.	p.43	
	Sound Effects	Volume	Sets the sound volume of beep sounds.	3	—
		In-focus	Sets whether to make a beep sound when the subject is focused.	On	p.46
		AE-L	Sets whether to make a beep sound when the exposure value is locked with AF/AE-L .	On	p.53
		Self-timer	Sets whether to make a beep sound during the countdown for Self-timer shooting.	On	p.67
		Remote Control	Sets whether to make a beep sound during the countdown for Remote Control shooting.	On	p.67
		Mirror Up	Sets whether to make a beep sound during Mirror Lock-up Shooting.	On	p.69
	Change AF Area	Sets whether to make a beep sound when the function of the arrow keys (▲▼◀▶) is switched to the AF area change mode.	On	p.63	

Menu	Item	Function	Default Setting	Page	
1	Sound Effects	One Push File Format	Sets whether to make a beep sound when the One Push File Format function is turned on with Fx1 or Fx2 .	On	p.107
		Wi-Fi	Sets whether to make a beep sound when the Wi-Fi function is turned on or off with Fx1 or Fx2 .	On	p.96
		Night Vision LCD Display	Sets whether to make a beep sound when the Night Vision LCD Display is turned on or off with Fx1 or Fx2 .	On	p.128
		Electronic Level	Sets whether to make a beep sound when the Electronic Level display is turned on or off with Fx1 or Fx2 .	On	p.19
2	LCD Display Settings		Sets the brightness, saturation, and color adjustment of the monitor.	0	p.110
	Outdoor View Setting		Adjusts the brightness of the monitor for outdoor shooting.	Off	p.110
	Night Vision LCD Display *1		Changes the monitor display color to red for shooting in a dark place such as night-time shooting.	Off	p.128
	Indicator Lamps	Other Indicator Lamps	Sets the brightness of the main switch lamp when the camera is turned on.	High	p.110
		Self-timer	Sets whether to make the self-timer lamp blinking during the countdown for the drive mode [Self-timer (12 sec.)].	On	
		Remote Control	Sets whether to make the remote control receiver lamp blinking during the standby time for the drive mode [Remote Control].	On	
		GPS LED Indicators	Sets whether to light up the GPS unit lamps when the GPS unit is attached.	On	
3	Wi-Fi *1		Activates the Wi-Fi function.	Off	p.96
	GPS/E-Compass	GPS Time Sync	Automatically adjusts the date and time settings.	On	p.126
		Calibration	Performs a calibration of direction information.	-	
	USB Connection		Sets the USB connection mode when connecting to a computer with a commercially available USB cable.	MSC	p.94

Menu	Item	Function	Default Setting	Page	
3	HDMI Out	Sets the output format when connecting to an AV device with an HDMI input terminal.	Auto	p.87	
	External Input Devices *1	Sets the external input device connected to the microphone/cable release terminal.	Auto Select	p.55	
	Auto Power Off	Sets the time until the camera turns off automatically if no operations are made for a certain period of time.	1min.	p.42	
4	Create New Folder	Creates a new folder on the memory card.	–	p.115	
	Folder Name	Sets the folder name in which images are stored.	Date	p.115	
	File Name	Sets the file name assigned to an image.	IMGP, _IMG	p.116	
	File No.	Sequential Numbering	Continues the sequential numbering for the file name when a new folder is created.	On	p.117
		Reset File Number	Resets the file number setting and returns to 0001 each time a new folder is created.	–	
	Copyright Information	Sets the photographer and copyright information embedded in the Exif data.	Off	p.117	
	Format	Formats a memory card.	–	p.44	
5	Pixel Mapping	Maps out and corrects defective pixels on the sensor.	–	p.130	
	Dust Removal	Cleans the sensor by applying high-frequency (ultrasonic) vibrations.	Off, Off	p.129	
	Sensor Cleaning	Locks the mirror in the up position for cleaning the sensor with a blower.	–	p.130	
	Certification Marks	Displays the certification marks of conformance to wireless technical standards.	–	p.146	
	Firmware Info/Options	Displays the camera's firmware version. You can check the current firmware version before running an update.	–	–	
	Reset	Resets the settings of the direct keys and for the items of the  menus,  menus,  menu,  menus, control panel, and playback mode palette.	–	–	

*1 Available as a function in the control panel.

Custom Setting Menus

1

Introduction

Menu	Item	Function	Default Setting	Page
C1	1 EV Steps	Sets the adjustment steps for the exposure.	1/3 EV Steps	p.52
	2 Sensitivity Steps	Sets the adjustment steps for the ISO sensitivity.	1 EV Step	p.56
	3 Meter Operating Time	Sets the meter operating time.	10sec.	–
	4 Auto EV Compensation	Automatically compensates the exposure when the correct exposure cannot be achieved with the current settings.	Off	–
	5 Link AE and AF Point	Sets whether to link the exposure value and the AF point in the focusing area.	Off	p.58
	6 AE-L with AF Locked	Sets whether to lock the exposure value when the focus is locked.	Off	–
	7 Bulb (B) Mode Options	Sets the camera operation when SHUTTER is pressed in B mode.	Type1	p.53
C2	8 Release While Charging	Sets whether to release the shutter while the built-in flash is being charged.	Off	p.60
	9 AF with Remote Control	Sets whether to use autofocus when shooting with a remote control unit.	Off	p.68
	10 Bracketing Order	Sets the order for Bracketing shooting.	0 - +	p.69
	11 One-Push Bracketing	Shoots all frames with one press of the release in Bracketing.	Off	p.69
	12 Interval Shooting Options	Sets whether to start counting the time of interval from when exposure starts or when exposure ends for Interval Shooting, Interval Composite, and Interval Movie Record.	Interval	p.72
	13 AF in Interval Shooting	Sets whether to lock the focus position used when the first picture is taken or perform autofocus for each exposure for Interval Shooting, Interval Composite, Interval Movie Record, and Star Stream.	Locks focus at 1st exposure	p.72
	14 WB Adjustable Range	Sets whether to automatically fine-tune the white balance when the light source is specified for the white balance setting.	Fixed	p.73

Menu	Item	Function	Default Setting	Page
C3	15 AWB in Tungsten Light	Sets the tungsten light color tone when the white balance is set to [Auto White Balance].	Strong Correction	p.73
	16 WB When Using Flash	Sets the white balance setting when using a flash.	Auto White Balance	p.73
	17 Color Temperature Steps	Sets the adjustment steps for the Color Temperature option of the white balance.	Kelvin	p.75
	18 4-way Controller Settings	Selects the operation of the arrow keys (▲▼◀▶) when the focusing area selection mode is set to one of some select-type options.	Type1	p.63
	19 Auto SR Off	Automatically turns off the Shake Reduction function when the drive mode is set to [Self-timer] or [Remote Control].	Enable Auto SR Off	p.66
	20 Save Rotation Info	Saves rotation information when shooting.	On	p.86
	21 Save Menu Location	Saves the last menu tab displayed on the monitor and displays it again the next time MENU is pressed.	Reset Menu Location	p.23
C4	22 Catch-in Focus	Enables Catch-in Focus shooting when a manual focus lens is attached. The shutter is released automatically when the subject comes into focus.	Off	p.124
	23 AF Fine Adjustment	Allows you to precisely fine-tune your lenses with the camera's autofocus system.	Off	p.65
	24 Using Aperture Ring	Enables the shutter to release when the lens aperture ring is set to a position other than A (Auto).	Disable	p.123
	Reset Custom Functions	Resets the settings of the Custom Setting menus to the defaults.	-	-

Attaching the Strap

- 1 Pass the end of the strap through the strap lug and secure it on the inside of the clasp.

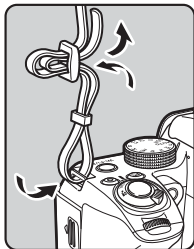

- 2 Attach the other end in the same manner.

Attaching a Lens

- 1 Make sure that the camera is turned off.
- 2 Remove the body mount cover (1) and lens mount cover (2).

After removing the cover, be sure to put the lens down with the lens mount side facing upward.

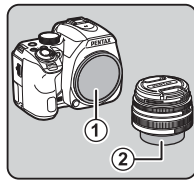

- 3 Align the lens mount indexes (red dots: 3) on the camera and the lens, and secure by turning the lens clockwise until it clicks.

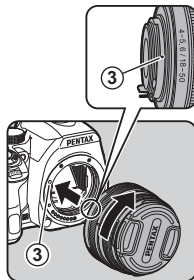

To remove the lens

Attach the lens cap, and then turn the lens counterclockwise while pressing the lens unlock button (4).

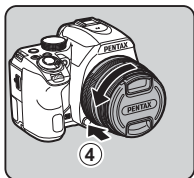

⚠ Caution

- When attaching or removing the lens, choose an environment that is relatively free of dirt and dust.
- Keep the body mount cover attached to the camera when a lens is not attached.
- Be sure to attach the lens mount cover and lens cap to the lens after removing it from the camera.
- Do not insert your fingers inside the lens mount of the camera or touch the mirror.
- The camera body and lens mount incorporate lens information contacts. Dirt, dust, or corrosion may damage the electrical system. Please contact your nearest service center for professional cleaning.
- When a retractable lens is attached and is not extended, you cannot take pictures or use some functions. If the lens is retracted during shooting, the camera stops working. Refer to "How to Use a Retractable Lens" (p.46) for details.
- We assume no responsibility nor liability for accidents, damages, and malfunctions resulting from the use of lenses made by other manufacturers.

📄 Memo

- Refer to "Functions Available with Various Lenses" (p.121) for details on the functions of each lens.

Using the Battery and Charger

Use the battery D-LI109 and battery charger D-BC109 exclusively developed for this camera.

Note: AC plug cord

UL Listed, Type SPT-2 or NISPT-2, 18/2 flexible cord, rated 125 V, 7 A, minimum 6 ft. (1.8 m)

Charging the Battery

- 1 Connect the AC plug cord to the battery charger.
- 2 Plug the AC plug cord into the power outlet.

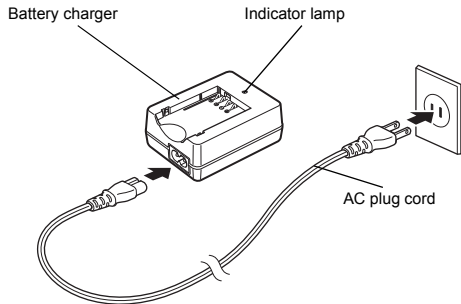

3 Face the ▲ mark on the battery up, and insert it into the battery charger.

Insert the battery into the battery charger at an angle, and then fit into place.

The indicator lamp lights while charging and turns off when the battery is fully charged.

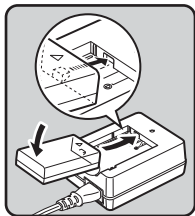

⚠ Caution

- Do not use the battery charger D-BC109 to charge batteries other than the battery D-LI109. Charging other batteries may cause damage or heating.
- Replace the battery with a new one in the following cases:
 - If the indicator lamp blinks or does not light after the battery is inserted correctly
 - If the battery starts to run down more quickly even after being charged (the battery may have reached the end of its service life)

📌 Memo

- The maximum charging time is approximately 240 minutes (it depends on temperature and remaining battery power). Charge the battery in a location where the temperature is between 0°C and 40°C (32°F and 104°F).

Inserting/Removing the Battery

⚠ Caution

- Insert the battery correctly. If the battery is inserted incorrectly, it may not be removed.
- Wipe the electrodes of the battery with a soft dry cloth before inserting.
- Do not open the battery cover or remove the battery while the power is on.
- Be careful as the camera or battery may become hot after the camera has been used continuously for a long period of time.
- Remove the battery when you do not use the camera for a long time. The battery may leak and damage the camera if left installed during prolonged periods of non-use. If the removed battery is not used for six months or longer, charge the battery for about 30 minutes before storing it. Be sure to recharge the battery every six to twelve months.
- Store the battery in a location where the temperature will remain at or below room temperature. Avoid locations with high temperatures.
- The date and time may be reset if you leave the battery out of the camera for long periods of time. If this happens, set the current date and time again. (p.42)

1 Open the battery cover.

Slide the battery cover unlock lever (1) before opening the cover.

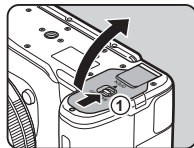

- 2** Face the ▲ mark on the battery towards the outside of the camera, and insert the battery until it locks into place.

To remove the battery, push the battery lock lever in the direction of ②.

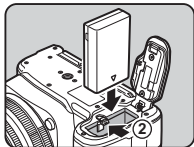

- 3** Close the battery cover.



Memo

- The battery level may not be displayed properly if the camera is used at low temperatures or when performing Continuous Shooting for a long time.
- Battery performance temporarily decreases as the temperature decreases. When using the camera in cold climates, have extra batteries at hand and keep them warm in your pocket. Battery performance will return to normal at room temperature.
- Have extra batteries ready when traveling overseas or taking a lot of pictures.

Using the AC Adapter

We recommend the use of the optional AC adapter kit K-AC168 when using the monitor for a long time or when connecting the camera to a computer or AV device.

- 1** Make sure that the camera is turned off.

- 2** Open the battery cover.

Remove the battery if it is inserted in the camera.

- 3** Pull out the connection cable cover on the right side of the battery chamber.

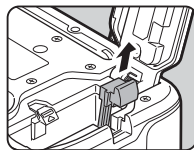

- 4** Insert the DC coupler into the battery chamber.

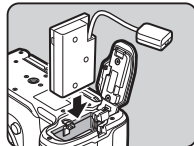

- 5** Close the battery cover.

Make sure that the connection cable comes out from the connection cable opening.

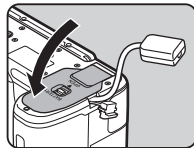

6 Connect the DC coupler and the AC adapter.

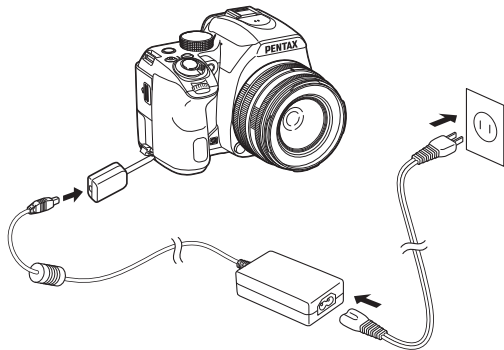

7 Connect the AC adapter to the AC plug cord, and plug the cord into the power outlet.

⚠ Caution

- Make sure that the camera is turned off before connecting or disconnecting the AC adapter.
- Make sure that the connections are secure between the terminals. The memory card or data may be corrupted if the connection to the power supply is lost while the card is being accessed.
- After removing the DC coupler, return the connection cable cover to its original position.
- Be sure to read the manual of the AC adapter kit before using the AC adapter.

Inserting a Memory Card

The following memory cards can be used with this camera.

- SD Memory Card
- SDHC Memory Card
- SDXC Memory Card

In this manual, these cards are referred to as memory cards.

1 Make sure that the camera is turned off.

2 Slide the memory card cover in the direction of ① and then rotate it to open as shown by ②.

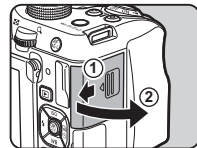

3 Insert a card all the way into the memory card slot with the memory card label facing toward the side with the monitor.

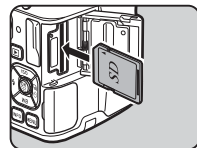

Push the memory card in once and release to remove.

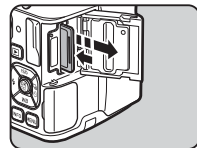

- 4** Rotate the memory card cover as shown by ③, and slide it in the direction of ④.

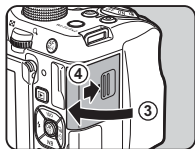

⚠ Caution

- Do not remove the memory card while the card access lamp (orange) is lit.
- If the memory card cover is opened while the power is on, the camera turns off. Do not open the cover while the camera is in use.
- Use this camera to format (initialize) a memory card that is unused or has been previously used on other devices. (p.44)
- Use a high-speed memory card when recording movies. If the write speed cannot keep up with the recording speed, writing may stop during recording.

How to Open the Monitor

The following procedure explains how to open the monitor with the LCD screen facing inward.

- 1** Open and rotate the monitor 180° to the left while holding the top and bottom of it.

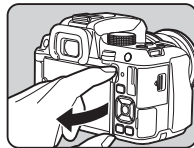

- 2** Rotate the monitor 180° backward.

The monitor can also be rotated up to 90° forward.

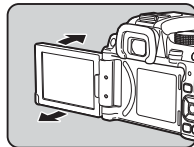

- 3** Close the monitor on the camera so that the LCD screen can be seen.

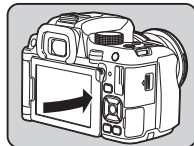

⚠ Caution

- When the monitor is closed with the LCD screen facing inward, you cannot play back images and display the menus unless the camera is connected to an AV device equipped with an HDMI terminal.
- Do not hold the camera by the monitor or rotate the monitor beyond its movable range.
- Do not carry the camera or put it in a bag with the monitor open. You can carry the camera when the monitor is closed regardless of the LCD screen direction.

📌 Memo

- To close the monitor with the LCD screen facing inward, rotate the monitor 180° forward in Step 2 and then 180° to the right.
- The items displayed on the monitor rotate according to the direction and angle of the monitor.

Initial Settings

Turn the camera on and make the initial settings.

Turning the Camera On**1 Turn the main switch to [ON].**

The lamp lights up in green. The first time the camera is turned on after purchase, the [Language/言語] screen appears.

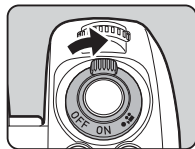
**📌 Memo**

- The power automatically turns off when you do not perform any operations within a set period of time. (Default setting: 1min.) You can change the setting in [Auto Power Off] of the 3 menu. (p.33)

Setting the Display Language**1 Use ▲▼◀▶ to select the desired language and press .**

The [Initial Setting] screen appears in the selected language.

Proceed to Step 6 if (Hometown) does not need to be changed.

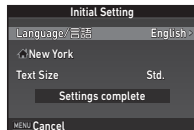
**2 Press ▼ to move the frame to and press ▶.**

The [Hometown] screen appears.

- 3 Use ◀▶ to select a city.**
Use 🌍 to change the region.
Refer to “List of World Time Cities” (p.138) for cities that can be selected as a hometown.

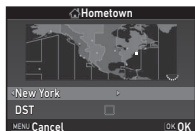

- 4 Press ▼ to select [DST] (daylight saving time), and use ◀▶ to select or .**
- 5 Press OK.**
The camera returns to the [Initial Setting] screen.

- 6 Press ▼ to select [Text Size] and press ▶.**

- 7 Use ▲▼ to select [Std.] or [Large], and press OK.**
Selecting [Large] increases the text size of the selected menu items.

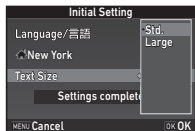

- 8 Press ▼ to select [Settings complete] and press OK.**
The [Date Adjustment] screen appears.

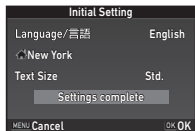

Setting the Date and Time

- 1 Press ▶, and use ▲▼ to select the date format.**

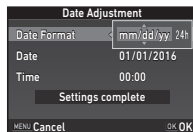

- 2 Press ▶, and use ▲▼ to select [24h] or [12h].**
- 3 Press OK.**
The frame returns to [Date Format].

- 4 Press ▼, and then press ▶.**
The frame moves to the month if the date format is set to [mm/dd/yy].

- 5 Use ▲▼ to set the month.**
Set the day, year, and time in the same manner.

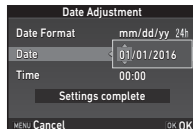

- 6 Press ▼ to select [Settings complete] and press OK.**
The [LCD Display] screen appears.

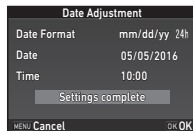

Setting the LCD Display

1 Use ◀▶ to select a color.

Select the display color of the status screen, control panel, and menu cursor from colors 1 to 12.

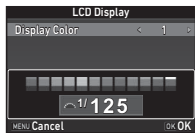

2 Press OK.

The camera switches to capture mode and is ready to take a picture.

Memo

- You can change the language, text size, and date and time settings from the 1 menu, and the display color from [Other Display Settings] of the 5 menu. (p.27, p.31)

Formatting a Memory Card

1 Press MENU.

The 1 menu appears.

2 Use ☀ or ☾ to display 4 menu.

3 Use ▲▼ to select [Format] and press ▶.

The [Format] screen appears.

4 Press ▲ to select [Format] and press OK.

Formatting starts. When formatting is completed, the 4 menu reappears.

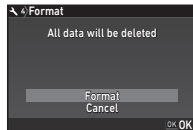

5 Press MENU.

Caution

- Do not remove the memory card while formatting, or the card may be damaged.
- Formatting deletes all data, both protected and unprotected.

Memo

- When a memory card is formatted, the volume label "K-70" is assigned to the card. When the camera is connected to a computer, the memory card is recognized as a removable disk with the name "K-70".

Basic Shooting Operation

Take pictures in the Auto Picture (**AUTO**) mode in which the camera automatically selects the optimal capture mode.

Shooting with the Viewfinder

- 1 Remove the front lens cap by pushing the top and bottom portions as indicated in the illustration.

When a retractable lens is attached, extend the lens before turning the camera on.

🔗 How to Use a Retractable Lens (p.46)

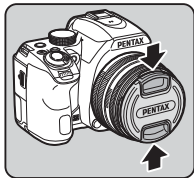

- 2 Turn the camera on.

- 3 Set the focus mode switch to **AF**.

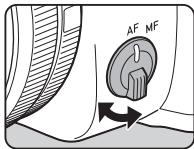

- 4 Turn the mode dial and align the dial indicator to **AUTO**.

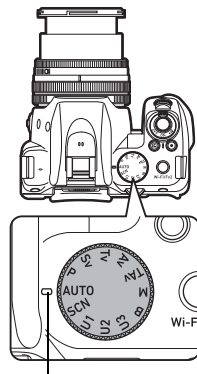

Dial indicator

The selected capture mode is displayed on the monitor (Guide Display).

🔗 Guide Display settings (p.27)

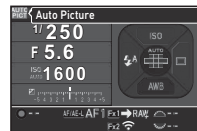

- 5 Look through the viewfinder to view the subject.

When using a zoom lens, turn the zoom ring to the right or left to change the angle of view.

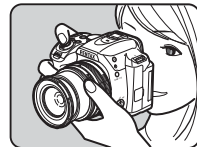

6 Position the subject inside the AF frame and press **SHUTTER** halfway.

The focus indicator (●) appears and you will hear a beep when the subject comes into focus.



Focus indicator

7 Press **SHUTTER** fully.

The captured image is displayed on the monitor (Instant Review).

Available operations during Instant Review



Deletes the image.



to the right Magnifies the image.



Saves the RAW data (only when a JPEG image was taken and the data remains in the buffer).

● Memo

- You can use **AF/AE-L** to focus on the subject. (p.61)
- You can select whether to make a beep sound and change the sound volume in [Sound Effects] of the **1** menu. (p.31)
- You can set the operation and display settings for Instant Review in [Instant Review] of the **5** menu. (p.27) When [Display Time] is set to [Hold], Instant Review is displayed until the next operation.

How to Use a Retractable Lens

If the camera is turned on when a retractable lens, such as smc PENTAX-DA L 18-50mm F4-5.6 DC WR RE, is attached and is not extended, an error message is displayed on the monitor. Turn the zoom ring in the direction of ② while pressing the button on the ring (①) to extend the lens. When retracting the lens, turn the zoom ring in the opposite direction to ② while pressing the button on the ring and align the white dot to the position ③.

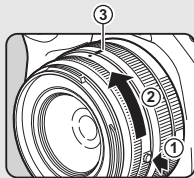

Shooting while Viewing the Live View Image

- 1 Press **LV** in Step 5 of “Shooting with the Viewfinder” (p.45).
The Live View image is displayed on the monitor.

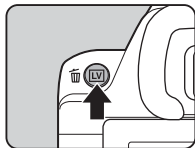



- 2 Position the subject inside the AF frame on the monitor and press **SHUTTER** halfway.

The AF frame turns green and you will hear a beep when the subject comes into focus.



AF frame

Available operations

- OK** Magnifies the image.
Use  to change the magnification (up to 16×).
Use  to change the area to display.
Press  to return the display area to the center.
Press **OK** to return to 1× image display.

- LV** Exits shooting with Live View.

Subsequent steps are the same as shooting with the viewfinder.

Reviewing Images

Review the captured image on the monitor.

- 1 Press .

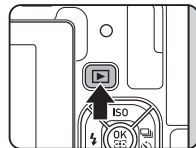













The camera enters playback mode and the most recently captured image is displayed (single image display).







2 Review the captured image.

Available operations

 to the left	Displays the previous image.
 to the right	Displays the next image.
	Deletes the image.
 to the right	Magnifies the image (up to 16×). Use     to change the area to display. Press  to return the display area to the center. Press OK to return to the entire image display.
 to the left	Switches to the thumbnail display (p.84).
	Saves the RAW data (only when a JPEG image was taken and the data remains in the buffer).
	Changes the type of information displayed (p.16).
	Displays the playback mode palette (p.83).

Memo

- When  is turned to the right to magnify the image, the magnification is displayed at the bottom right of the screen. You can set the initial magnification when magnifying images in [Quick Zoom] of the  1 menu. (p.30)
- When  RAW is displayed on the monitor, the JPEG image that was just taken can also be saved in RAW format (Save RAW Data).
- You can display grid lines in single image display. Set in [Grid Display] of [LCD Display] in the  1 menu. (p.31)

Configuring the Capture Settings

Image Capture Settings



Set the file format for still pictures in [Image Capture Settings] of the 2 menu.

File Format	JPEG, RAW, RAW+
JPEG Recorded Pixels	[L], [M], [S], [XS]
JPEG Quality	★★★, ★★, ★
RAW File Format	PEF, DNG
Color Space	sRGB, AdobeRGB

Memo

- When [File Format] is set to [RAW+], a JPEG image and a RAW image with the same file number are saved at the same time.
- You can change the setting so that you can take pictures in another file format when **Fx1** or **Fx2** is pressed. (p.107)
- [PEF] of [RAW File Format] is a PENTAX original RAW file format.

Movie Capture Settings











Set the file format for movies in [Movie Capture Settings] of the 1 menu.

Recorded Pixels	Framerate
	60i, 50i, 30p, 25p, 24p
	60p, 50p

Taking Still Pictures

Select the capture mode that suits the subject and shooting conditions.

The following capture modes are available on this camera.

Capture Mode	Function	Page
AUTO (Auto Picture modes)	Automatically selects the optimal capture mode from  (Standard),  (Portrait),  (Landscape),  (Macro),  (Moving Object),  (Night Scene Portrait),  (Sunset),  (Blue Sky), or  (Forest).	p.45
SCN (Scene modes)	Offers you various scene modes to choose from.	p.50
P, Sv, Tv, Av, TAv, M, B (Exposure modes)	Allows you to change the shutter speed, aperture value, and sensitivity.	p.51
U1 (CLEAR TONE)	Creates a clear and bright atmosphere in pictures.	-
U2 (HDR LANDSCAPE)	Gives a bold and dramatic look to landscape shots.	
U3 (ASTROPHOTO)	Adjusts the background black level and reproduces the colors of stars faithfully.	







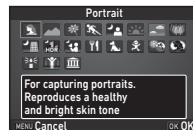

Memo











- The functions that can be set vary depending on the capture mode. Refer to “Restrictions on Each Capture Mode” (p.118) for details.
- You can save frequently used exposure modes and capture settings as USER modes to **U1** to **U3** and replace the preset settings with them. (p.111)

Scene Modes

- 1 Set the mode dial to SCN.**
The scene mode selection screen appears.
- 2 Select a scene mode.**



 Portrait	For capturing portraits. Reproduces a healthy and bright skin tone.
 Landscape	For capturing landscape views. Reproduces the vivid green of trees.
 Macro	For capturing tiny objects at close focus range like flowers, coins, jewelry, and more.
 Moving Object	For capturing images of fast moving subjects.
 Night Scene Portrait	For capturing images of people in low light conditions, such as dusk or at night.
 Sunset	For capturing sunrises or sunsets in beautiful, vivid color.
 Blue Sky	For capturing images of blue sky. Produces a more impressive deep blue.
 Forest	Enhances colors of trees and sunbeams through foliage and produces a vivid color image.

 Night Scene	Used for shooting at night.
 Night Scene HDR	Takes three consecutive images at three different exposure levels (-1, +0, +1) to create a single composite image from them.
 Night Snap	For taking snapshots in poorly lit places.
 Food	For capturing images of food. Saturation will be rather high to make food look appetizing.
 Pet	For capturing moving pets.
 Kids	For capturing moving kids. Reproduces healthy and bright skin tone.
 Surf & Snow	For capturing images of dazzling backgrounds, such as snowy mountains.
 Backlight Silhouette	Produces a silhouette image of the subject in backlight conditions.
 Candlelight	For capturing scenes in candlelight.
 Stage Lighting	For capturing moving subjects in poorly lit places.
 Museum	For capturing images in places where a flash is prohibited.

3 Press .

The camera is in standby mode.

Turn  to change the scene mode.

Memo

- You can change the scene mode also from the  1 menu.

Exposure Modes

✓: Available #: Restricted ✗: Not available

Mode	Change Shutter Speed	Change Aperture Value	Change Sensitivity	EV Compensation
P Program Automatic Exposure	# *1	# *1	✓	✓
Sv Sensitivity Priority Automatic Exposure	✗	✗	✓ *2	✓
Tv Shutter Priority Automatic Exposure	✓	✗	✓	✓
Av Aperture Priority Automatic Exposure	✗	✓	✓	✓
TAv Shutter & Aperture Priority Automatic Exposure	✓	✓	✗ *3	✓
M Manual Exposure	✓	✓	✓ *2	✓
B Bulb Exposure	✗ *4	✓	✓ *2	✗

*1 You can set the value to change in [E-Dial Programming] of [Button Customization] in the  5 menu. (p.109)

*2 [ISO AUTO] is not available.

*3 Fixed to [ISO AUTO].

*4 When the timed exposure is enabled, shutter speeds ranging from 10 seconds to 20 minutes can be set.

1 Set the mode dial to the desired exposure mode.

or appears on the status screen for the value that can be changed.

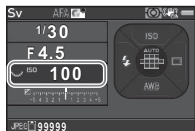

The value that can be changed is underlined in the viewfinder.



During Live View, appears for the value that can be changed.



2 Turn .

The aperture value is changed in **Av**, **TAv**, **M**, or **B** mode.
The sensitivity is changed in **Sv** mode.

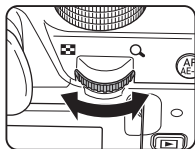

3 Turn .

The shutter speed is changed in **Tv**, **TAv**, or **M** mode.

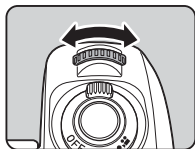

Memo

- The settings for the exposure can be specified in increments of 1/3 EV steps. In [1 EV Steps] of the **C1** menu, you can change the adjustment steps to 1/2 EV steps.
- In **M** mode, the difference from the correct exposure is displayed on the EV bar scale while the exposure is adjusted.
- For each exposure mode (excluding **B** mode), you can set the camera operation for when or is turned or is pressed. Set in [E-Dial Programming] of [Button Customization] in the 5 menu. (p.109)

Caution

- The correct exposure may not be obtained with the selected shutter speed and aperture value when the sensitivity is fixed at a certain sensitivity.

Noise Reduction when Shooting with a Slow Shutter Speed

When shooting with a slow shutter speed, you can reduce image noise in [Slow Shutter Speed NR] of [Noise Reduction] in the 2 menu.

Auto	Applies Noise Reduction according to the shutter speed, sensitivity, and internal temperature of the camera.
On	Applies Noise Reduction when the shutter speed is slower than 1 second.
Off	Does not apply Noise Reduction at any shutter speed.

Checking the Depth of Field (Preview)

When [Preview] is assigned to **Fx1** or **Fx2** in [Button Customization] of the **5** menu, you can check the depth of field before taking pictures. (p.106)

Locking the Exposure

To lock the exposure before shooting, use the AE Lock function. This function can be used by assigning [AE Lock] to the **AF/AE-L** button in [Button Customization] of the **5** and **2** menus. (p.106)

Bulb Exposure

1 Set the mode dial to **B**.

2 Use  to set the aperture value.



3 To enable the timed exposure, press **O**, and then use  to set the exposure time.

You can set the exposure time within the range from 10" to 20'00".

4 Press **SHUTTER**.

While **SHUTTER** is pressed, exposure continues.

If the timed exposure is enabled in Step 3, the exposure ends when the set exposure time elapses after **SHUTTER** is fully pressed.

Memo

- You can start and end exposure also by pressing **SHUTTER**. Set in [7 Bulb (B) Mode Options] of the **C1** menu.
- When performing the bulb exposure, use a tripod and mount the camera on it securely. The use of the optional remote control unit or cable release is recommended. (p.55, p.67)

Caution

- The drive mode cannot be set to [Continuous Shooting], [Bracketing], or [Interval Shooting].

Recording Movies

- 1** Turn the main switch to .

The indicator lamp lights red and the Live View image is displayed.

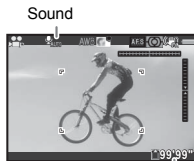
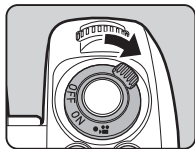

Recordable Time

- 2** Set the mode dial to the desired capture mode.

The following settings are available depending on the capture mode.

P, Av, TAv, M	The camera operates in the selected exposure mode. (The aperture value can be changed only before shooting. When set to M mode, the sensitivity can also be changed.)
U1 to U3	The camera operates according to the saved exposure mode.
Other modes	The camera operates in P mode.

- 3** Focus on the subject.

In **AF** mode, press **SHUTTER** halfway.

- 4** Press **SHUTTER** fully.

Movie recording starts.

In the upper left area of the monitor, "REC" blinks and the size of the recorded movie file is displayed.

- 5** Press **SHUTTER** fully again.

Movie recording stops.

- 6** Return the main switch to the [ON] position to exit  mode.

The camera returns to shooting with the viewfinder in  mode.

⚠ Caution

- When recording a movie with sound, camera operation sounds are also recorded.
- When recording a movie with an image processing function such as Digital Filter applied, the movie file may be saved with some frames omitted.
- If the internal temperature of the camera becomes high during recording, recording may be terminated.
- When a retractable lens is attached, recording stops if the lens is retracted during recording and an error message is displayed.
- In  mode, the Wi-Fi function is disabled.

Focus Motor Noise during Movie Recording

When [AF Mode] of [AF with Live View] in the  1 menu is set to **A.F.C.**, focus motor drive noise is recorded.

Adjusting the sound level in [Recording Sound Level] of the  1 menu, or using an external microphone can reduce the motor noise to be recorded.

Memo

- You can change the movie settings in the menus. (p.29)
- By default, autofocus is not performed when **SHUTTER** is pressed halfway during movie recording. If a compatible lens is attached to the camera, you can select **A.F.C** in [AF Mode] of [AF with Live View] in the 1 menu and continuously autofocus even during movie recording. (p.63) When [AF Mode] is set to **A.F.C**, the **AF/AE-L** button operation varies as follows depending on the setting assigned to **AF/AE-L** in [Button Customization] of the 2 menu. (p.106)

[Button Customization] setting	Autofocus operation when AF/AE-L is pressed
Enable AF1, Enable AF2	Pressing AF/AE-L performs autofocus based on the [AF Mode] setting.
Cancel AF	Pressing AF/AE-L stops autofocus and pressing AF/AE-L again restarts autofocus.

- The sound volume for recording a movie can be set in [Recording Sound Level] of the 1 menu. When [Manual] is selected, the sound volume can be set from 0 to 20.
- You can record a movie continuously up to 4 GB or 25 minutes. When the memory card is full, recording stops.

Using a Microphone or Cable Release

You can connect a commercially available stereo microphone to the microphone/cable release terminal on the camera. Using an external microphone can also help to reduce the possibility of recording camera operation sounds.

The following specifications are recommended for external microphones. (A monaural microphone cannot be used with this camera.)

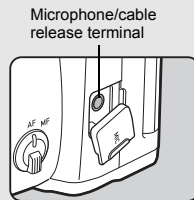

Plug	Stereo mini plug (ø3.5 mm)
Format	Stereo electret condenser
Power	Plug-in Power Method (operating voltage of 2.0 V or lower)
Impedance	2.2 kΩ

You can also connect the optional Cable Switch CS-310 to the microphone/cable release terminal on the camera. When the cable release is connected, sounds are recorded with the built-in microphone.

You can set the device to connect in [External Input Devices] of the 3 menu. Normally, you do not need to change the default setting ([Auto Select]).

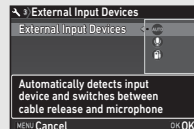

Caution

- Do not connect a microphone or other device outside the recommended specifications to the microphone/cable release terminal. Doing so may cause the camera to malfunction.

Playing Back Movies

- 1 Display the movie to play back in single image display of the playback mode.



Available operations

▲	Plays back/pauses a movie.
▶	Forwards a frame (when paused).
Press and hold ▶	Fast-forwards playback.
◀	Reverses a frame (when paused).
Press and hold ◀	Fast-reverses playback.
▼	Stops playback.
	Adjusts the sound volume (21 levels).
	Saves the displayed frame as a JPEG file (when paused).
	Switches between [Standard Information Display] and [No Information Display].

Memo

- The sound volume at the start of movie playback can be set in [Playback Sound Volume] of the 1 menu. (p.31)
- In [Movie Edit] of the playback mode palette, a movie file can be divided into multiple segments or selected frames can be deleted. (p.91)

Setting the Exposure

Sensitivity

- 1 Press ▲ in standby mode.
- 2 Use ▲▼ to select an item.

ISO AUTO	Sets the range to be adjusted automatically. Both the upper limit and lower limit can be changed.
ISO	Sets a fixed value from ISO 100 to ISO 102400.

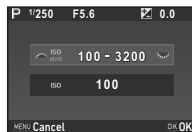

- 3 Use or to change the value.
- 4 Press .

The camera returns to standby mode.

Memo

- The adjustment steps for ISO sensitivity is 1 EV step. To adjust the sensitivity in accordance with the EV step setting for the exposure, set from [2 Sensitivity Steps] of the 1 menu.
- When the sensitivity is set to ISO 102400, ISO value is displayed in the viewfinder by a combination of the letter "H" and the three-digit number "102" (H102).

Noise Reduction when Shooting with a High ISO Sensitivity



You can set the Noise Reduction setting when shooting with a high ISO sensitivity.

- 1 Select **[Noise Reduction]** in **☰2** menu and press **▶**.

The [Noise Reduction] screen appears.

- 2 Select **[High-ISO NR]** and press **▶**.

- 3 Select the Noise Reduction level and press **OK**.

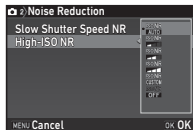

Auto	Applies Noise Reduction at optimally calculated levels throughout ISO range.
Low, Medium, High	Applies Noise Reduction at constant chosen level throughout ISO range.
Custom	Applies Noise Reduction at user-defined levels for each ISO setting.
Off	Does not apply Noise Reduction at any ISO setting.

Proceed to Step 7 when other than [Custom] is selected.

- 4 Select **[Setting]** and press **▶**.

- 5 Select the Noise Reduction level for each ISO setting.

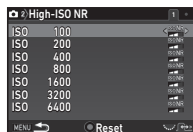

Available operations



Shows the next/previous page.



Resets the Noise Reduction level to the default setting.

- 6 Press **MENU**.
- The screen of Step 3 reappears.

- 7 Press **MENU** twice.

EV Compensation

The compensation value can be set between -5 and +5 EV (-2 and +2 EV in  mode).

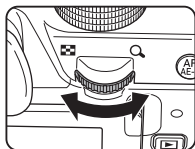
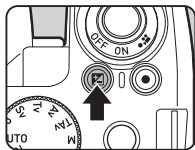

- 1 Press , and then turn .

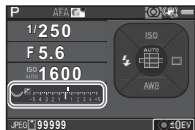

 and the compensation value are displayed on the status screen, Live View screen, and in the viewfinder during adjustment.



Available operations



-  Starts/ends adjusting the compensation value.
-  Resets the adjustment value to the default setting.



Memo

- Bracketing shooting enables you to take pictures while automatically changing exposure. (p.68)

AE Metering



Choose the part of the sensor to use for measuring brightness and determining the exposure in [AE Metering] of the  1 and  1 menus.

 Multi-segment	Meters the brightness in multiple different zones of the sensor. In backlit conditions, this mode automatically adjusts the exposure.
 Center-weighted	Meters the brightness with an emphasis on the center of the sensor. The sensitivity increases at the center and no automatic adjustment is performed even in backlit conditions.
 Spot	Meters the brightness only within a limited area at the center of the sensor. Useful when the subject is small.

Memo

- In [5 Link AE and AF Point] of the  1 menu, the metering point and the AF point can be linked.

Using the Built-in Flash

1 Press **◀** in standby mode.

2 Select a flash mode.



	Auto Flash Discharge	Automatically measures the ambient light and determines whether to use the flash.
	Auto Flash + Red-eye	Discharges a pre-flash for red-eye reduction before an automatic flash.
	Flash On	Discharges a flash for each picture.
	Flash On + Red-eye	Discharges a pre-flash for red-eye reduction before the main flash for each picture.
	Slow-speed Sync	Sets to a slow shutter speed and discharges a flash for each picture. Use this, for example, when shooting a portrait with the sunset in the background.
	Slow Sync + Red-eye	Discharges a pre-flash for red-eye reduction before the main flash is discharged with Slow-speed Sync.

	Trailing Curtain Sync	Discharges a flash immediately before closing the shutter. Sets to a slow shutter speed. Captures moving objects as if they are leaving a light trail behind them.
	Manual Flash Discharge	Sets the amount of flash discharge between FULL and 1/128 power.

Available operations



Compensates the flash exposure.

Selects the amount of flash discharge (when [Manual Flash Discharge] is selected).



Resets the compensation value to the default setting.

3 Press **OK**.

The camera returns to standby mode.





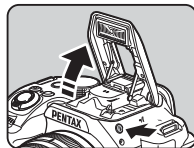









4 Press .

The built-in flash is popped up.



Memo

- The flash modes that can be selected vary depending on the capture mode.

Capture Mode	Selectable Flash Mode
AUTO, SCN *1	 ,  ,  , 
P, Sv, Av	 ,  ,  ,  ,  ,  , 
Tv, TvAv, M, B	 ,  ,  , 

*1 The built-in flash cannot be used for some scene modes. (p.118)

- You cannot take pictures while the built-in flash is being charged. If you want to take pictures while charging the flash, set [8 Release While Charging] in the **C2** menu.
- Depending on the lens being used, the use of the built-in flash may be limited. (p.122)
- When the built-in flash is used in **Av** mode, the shutter speed automatically changes over a range from 1/180 seconds to a slow shutter speed depending on the lens being used. The shutter speed is locked at 1/180 seconds when a lens other than a DA, DA L, D FA, FA J, FA, or F lens is used.
- When the built-in flash is used in **Tv**, **TvAv**, or **M** mode, any desired shutter speed of 1/180 seconds or slower can be set.
- The built-in flash is optimum for a subject at a distance from approx. 0.7 m to 5 m. Vignetting may occur when used at a distance closer than 0.7 m (this distance varies slightly depending on the lens being used and the sensitivity setting).
- For details on the use of external flashes, refer to "Functions when Using an External Flash" (p.125).

Guide Number

Sensitivity	Guide Number	Sensitivity	Guide Number
ISO 100	Approx. 12	ISO 6400	Approx. 96
ISO 200	Approx. 17	ISO 12800	Approx. 136
ISO 400	Approx. 24	ISO 25600	Approx. 192
ISO 800	Approx. 34	ISO 51200	Approx. 272
ISO 1600	Approx. 48	ISO 102400	Approx. 384
ISO 3200	Approx. 68		

Setting the Focus Method

Set the focus mode switch to **AF** or **MF**.

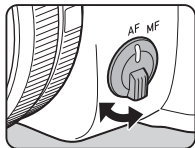

The autofocus method for shooting with the viewfinder differs from that for shooting with Live View.

Shooting with the viewfinder	TTL phase-matching AF: Select from AF.S , AF.C , or AFA mode which enables automatically switching between AF.S and AF.C . Faster autofocus performance than the contrast detection AF is possible. (p.61)
Shooting with Live View	Image plane phase-matching AF + contrast detection AF: Face Detection and Tracking are available. (p.63)

Focusing on the Subject Using the AF/AE-L Button

You can use **AF/AE-L** to focus on the subject. The **AF/AE-L** button operation can be set in [Button Customization] of the **☑5** and **☑2** menus. (p.106)

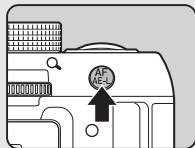

Setting the Autofocus when Shooting with the Viewfinder



The autofocus operation when shooting with the viewfinder can be set in [AF with Viewfinder] of the **☑1** menu.



AF Mode	AF.A, AF.S, AF.C
AF Active Area	☑1, ☑2, ☑3, ☑4, ☑5, ☑6
AF.S Setting	Focus-priority, Release-priority
1st Frame Action in AF.C	Auto, Focus-priority, Release-priority
Action in AF.C Cont.	Auto, Focus-priority, FPS-priority
Hold AF Status	Off, Low, Medium, High

In [Hold AF Status], you can set whether to immediately reactivate autofocus or to maintain the focus for a certain amount of time before reactivating autofocus when the subject happens to move out of the selected focusing area after being focused.

AF Mode

- 1 Select an autofocus mode in [AF Mode] on the [AF with Viewfinder] screen.

A.F.A (Auto-select mode)	Switches automatically between A.F.S and A.F.C modes according to the subject.
A.F.S (Single mode)	When SHUTTER is pressed halfway and the subject comes into focus, the focus is locked at that position. The AF assist light turns on as necessary.
A.F.C (Continuous mode)	The subject is kept in focus by continuous adjustment while SHUTTER is pressed halfway. The shutter can be released even if the subject is not in focus.





- 2 Press **OK**.
- 3 Press **MENU** twice.
The camera returns to standby mode.



 **Memo**

- In **SCN** mode, the autofocus mode is fixed to **A.F.S** or **A.F.C** depending on the selected scene mode. (p.118)
- In **AUTO** mode, the autofocus mode is fixed to **A.F.A**.

AF Active Area (AF Point)

- 1 Select a focusing area selection mode in [AF Active Area] on the [AF with Viewfinder] screen.

 Auto (11 AF Points)	Out of the 11 AF points, the camera automatically selects the optimum focusing area.
 Auto (5 AF Points)	Out of the 5 AF points, the camera automatically selects the optimum focusing area.
 Select	Sets the focusing area to the user selected point from 11 points.
 Expanded Area AF	Sets the focusing area to the user selected point from 11 points. When the subject happens to move out of the selected focusing area after being focused, 8 peripheral points are used as back-up points. Not available in A.F.S mode.
 Spot	Sets the focusing area to the center of the 11 points.

- 2 Press **OK**.
- 3 Press **MENU** twice.
The camera returns to standby mode.
If you selected  or  in Step 1, proceed to Step 4.

4 Select the desired AF point.



Available operations

▲▼◀▶	Changes the AF point.
OK	Returns the AF point to the center.
Press and hold OK	Switches the function of the arrow keys (▲▼◀▶) to the AF point change mode or the direct key operation mode.

Memo

- You can also set the camera so that switching to the AF point change mode by pressing and holding **OK** can be operated with **Fx1** or **Fx2**. (p.106)
- You can select the button operation when changing the focusing area in [18 4-way Controller Settings] of the **C3** menu.

Type1	Switches the operation of the arrow keys (▲▼◀▶) to the AF point change mode or the direct key operation mode.
Type2	Prioritizes the AF point change mode in standby mode.

Setting the Autofocus when Shooting with Live View



The autofocus operation when shooting with Live View can be set in [AF with Live View] of the **1/1** and **1/1** menus.

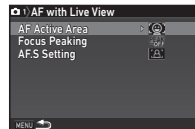

AF Active Area	
Focus Peaking	On, Off
AF.S Setting	Focus-priority, Release-priority

When [Focus Peaking] is set to [On], the outline of the subject in focus is emphasized, and this makes it easier to check the focus. This function works in both **AF** and **MF** modes.

AF Mode



The menu item [AF Mode] in [AF with Live View] of the **1/1** can be changed to **A.F.C** only when a compatible lens is attached to the camera.





1 Select an autofocus mode in [AF Mode] on the [AF with Live View] screen.

Select from **A.F.S** or **A.F.C**.



2 Press **OK**.

AF Active Area

- 1** Select a focusing area selection mode in [AF Active Area] on the [AF with Live View] screen.

 Face Detection	Detects and tracks faces of people. The main face detection frame for AF and AE is displayed in yellow.
 Tracking	Tracks the subject in focus. The shutter can be released even if the subject is not in focus.
 Multiple AF Points	Sets the focusing area to the desired area. The sensor is divided into 35 areas (7 horizontal by 5 vertical), and you can select a wider or narrower focusing area by using 1, 9, 15, or 25 of those 35 available areas.
 Select	Sets the focusing area by the pixel.
 Spot	Sets the focusing area to a limited area at the center.

Select from , , or  in  mode.

- 2** Press **OK**.
- 3** Press **MENU** twice.
The camera returns to standby mode.
If you selected  or  in Step 1, proceed to Step 4.
- 4** Press and hold **OK**.

- 5** Select the AF area.
Use the frame that appears on the monitor to change the position and size of the AF area.



Available operations



Changes the position of the AF area.



Increases/reduces the size of the AF area (when  is selected).



Returns the AF area to the center.





- 6** Press **OK**.

The AF area is set.

 **Caution**

- When  is selected, the focus lock operation (composition adjustment with the half press of **SHUTTER**) does not work.

 **Memo**

- You can also set the camera so that switching to the AF area change mode by pressing and holding **OK** can be operated with **Fx1** or **Fx2**. (p.106)
- [AF Active Area] is fixed to  in **AUTO** mode and , , and  of **SCN** mode.

You can precisely fine-tune your lenses with the camera's autofocus system.

- 1 Select **[23 AF Fine Adjustment]** in **C4** menu and press **▶**.

The [23 AF Fine Adjustment] screen appears.

- 2 Select **[Apply All]** or **[Apply One]** and press **OK**.

Apply All	Applies the same adjustment value to all lenses.
Apply One	Saves an adjustment value for the lens being used. (Up to 20 values)

- 3 Select **[Setting]** and adjust the value.



Available operations

	Adjusts the focus to a closer position.
	Adjusts the focus to a farther position.
	Resets the adjustment value to the default setting.

- 4 Press **OK**.

The adjustment value is saved.

- 5 Press **MENU** twice.

The camera returns to standby mode.







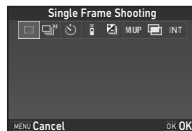

Setting the Drive Mode

- 1 Press **▶** in standby mode.

The Drive Mode screen appears.



- 2 Select a drive mode.

Single Frame Shooting ()	Normal capture mode
Continuous Shooting ()	Continuously takes pictures while SHUTTER is kept pressed. (p.66)
Self-timer ()	Releases the shutter about 12 seconds or 2 seconds after SHUTTER is pressed. (p.67)
Remote Control ()	Enables shooting with remote control. (p.67)
Bracketing ()	Takes consecutive pictures at different exposure levels. (p.68)
Mirror Lock-up Shooting (MUP , )	Takes pictures with the mirror raised. (p.69)
Multi-exposure ()	Creates a composite image by taking multiple pictures and merging them into a single image. (p.70)
Interval Shooting (INT , )	Automatically takes pictures at set intervals. (p.71)

⚠ Caution

- There are restrictions on some drive modes when used in some capture modes or in combination with some other functions. (p.118)

📝 Memo

- In **📷** mode, you can select only [Remote Control Off] or [Remote Control].
- The Drive Mode setting is saved even after the power is turned off. If [Drive Mode] is set to **☐** (Off) in [Memory] of the **📷5** menu, the setting returns to [Single Frame Shooting] when the power is turned off. (p.113)
- The [Shake Reduction] of the **📷4** menu is automatically set to [Off] when the drive mode is set to [Self-timer] or [Remote Control]. If you do not want to turn off the Shake Reduction function, set in [19 Auto SR Off] of the **C3** menu.

If Light Enters through the Viewfinder

When the drive mode that employs the self-timer or remote control is selected, exposure may be affected by the light entering through the viewfinder. In such a case, use the AE Lock function. (p.53)

Continuous Shooting

- 1 Select **📷^H** on the Drive Mode screen and press **▼**.

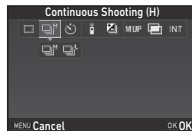

- 2 Use **◀▶** to select **📷^H** or **📷^L**, and press **OK**.

📷^H	Continuous Shooting (at high speed)
📷^L	Continuous Shooting (at low speed)

The camera returns to standby mode.

📝 Memo



- When [AF Mode] in [AF with Viewfinder] of the **📷1** menu is set to **A.F.S.**, the focus position is locked in the first frame. (p.62)

Self-timer

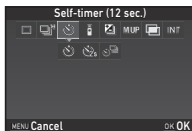
- 1 Select  on the Drive Mode screen and press **▼**.



- 2 Use **◀▶** to select , , or .

	Self-timer (shutter release after about 12 seconds)
	Self-timer (shutter release after about 2 seconds)
	Self-timer + Continuous Shooting

Proceed to Step 6 when  or  is selected.

- 3 Press **INFO**.

- 4 Set [Shooting Speed] and [Number of Shots].

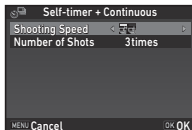

- 5 Press **OK**.

The screen of Step 1 reappears.

- 6 Press **OK**.

The camera returns to standby mode.

- 7 Press **SHUTTER** halfway, and then fully.



The shutter is released after about 12 seconds or 2 seconds.

Remote Control

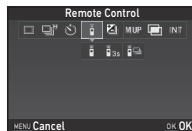
- 1 Select  on the Drive Mode screen and press **▼**.



- 2 Use **◀▶** to select , , or .

	Remote Control
	Remote Control (shutter release after about 3 seconds)
	Remote Control + Continuous Shooting

Proceed to Step 6 when  or  is selected.

- 3 Press **INFO**.

- 4 Set [Shooting Speed].

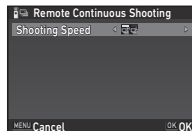

- 5 Press **OK**.

The screen of Step 1 reappears.

- 6 Press **OK**.

The camera returns to standby mode.

- 7 Press **SHUTTER** halfway.

- 8** Point the remote control unit towards the remote control receiver on the front of the camera, and press the shutter release button on the remote control unit.

Memo



- The maximum operating distance of the remote control unit is approximately 4 m from the front of the camera.
- To adjust focus with remote control, set in [9 AF with Remote Control] of the **C2** menu.
- When using the Remote Control Waterproof O-RC1, the autofocus system can be operated with the $\frac{1}{\infty}$ button on the remote control unit. The **Fn** button cannot be used.

Bracketing

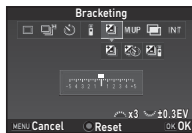
- 1** Select  on the Drive Mode screen and press \blacktriangledown .



- 2** Use \blacktriangleleft to select , , or .

	Bracketing
	Bracketing + Self-timer
	Bracketing + Remote Control

Proceed to Step 6 when  is selected.

- 3** Press **INFO**.

- 4** Select the operation mode.

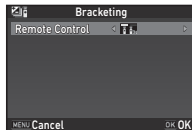
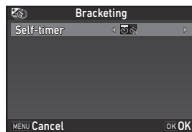

5 Press **OK**.

The screen of Step 1 reappears.

6 Set the number of shots and bracket value.

Available operations

	Sets the number of shots.
	Changes the bracket value.
	Adjusts the exposure compensation value.
	Resets the adjustment value to the default setting.

7 Press **OK**.

The camera returns to standby mode.

8 Shoot.

After pictures are taken, the camera returns to standby mode.

Memo

- The bracket value can be set in increments of 1/3 EV steps or 1/2 EV steps according to the [1 EV Steps] setting of the **C1** menu.
- The following settings for Bracketing can be set in the **C2** menu.

10 Bracketing Order	Changes the shooting order of pictures.
11 One-Push Bracketing	Takes all pictures with one release of the shutter.

Mirror Lock-up Shooting

1 Select **MUP** on the Drive Mode screen and press **▼**.

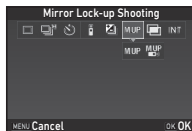

2 Use **◀▶** to select **MUP** or **MUP+RC**.

MUP	Mirror Lock-up Shooting
MUP+RC	Mirror Lock-up Shooting + Remote Control

3 Press **OK**.

The camera returns to standby mode.

4 Press **SHUTTER** halfway, and then fully.

The mirror pops up and the AE Lock function is activated.

5 Press **SHUTTER** fully again.

The picture is taken and then the mirror returns to its original position.

Memo

- The mirror automatically returns to its original position if 1 minute elapses after the mirror pops up.

Caution



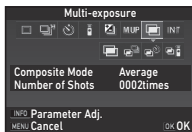

- While this function is used, [Shake Reduction] of the **Q4** menu is fixed to [Off].

Multi-exposure

- 1 Select  on the Drive Mode screen and press ▼.



- 2 Use ◀▶ to select , , , or .

	Multi-exposure
	Multi-exposure + Continuous Shooting
	Multi-exposure + Self-timer
	Multi-exposure + Remote Control

Proceed to Step 6 if you do not need to change the shooting conditions.

- 3 Press **INFO**.

- 4 Set the shooting conditions.

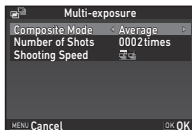



Composite Mode	Select from [Average], [Additive], or [Bright].
Number of Shots	Select from 2 to 2000 times.
Shooting Speed/ Self-timer/ Remote Control	Specify the operation mode for the selected shooting mode.

- 5 Press **OK**.
The screen of Step 1 reappears.

- 6 Press **OK**.
The camera returns to standby mode.

- 7 Shoot.
Instant Review is displayed.

Available operations during Instant Review

	Discards pictures taken up to that point and takes pictures again from the first picture.
MENU	Saves pictures taken up to that point and displays the  menu.

After the specified number of shots are taken, the camera returns to standby mode.

Memo

- Composite images are created as follows in each Composite Mode.

Average	Creates a composite image with the average exposure.
Additive	Creates a composite image with the cumulatively added exposure.
Bright	Creates a composite image replacing only the portions that are brighter compared with the first image.

Interval Shooting

- 1 Select **INT** on the Drive Mode screen and press **▼**.

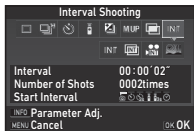

- 2 Use **◀▶** to select **INT**, **[Interval Composite]**, **[Interval Movie Record]**, or **[Star Stream]**.

INT	Interval Shooting Takes pictures at set intervals and saves them.
[Interval Composite]	Interval Composite Takes pictures at set intervals and merges them into a single image.
[Interval Movie Record]	Interval Movie Record Takes still pictures at set intervals and saves them as a single movie file (Motion JPEG, file extension: .AVI).
[Star Stream]	Star Stream Takes still pictures at set intervals and merges them into a single movie file (Motion JPEG, file extension: .AVI) using Interval Composite.

Proceed to Step 6 if you do not need to change the shooting conditions.



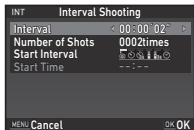

- 3 Press **INFO**.
- 4 Set the shooting conditions.



Recorded Pixels	Select from [4K] , [FullHD] , or [HD] (only for [Movie] and [Photo]).
Interval	Select from 2 seconds to 24 hours.
Standby Interval	Select from the minimum time or 1 second to 24 hours.
Number of Shots	Select from 2 to 2000 times.
Start Interval	Select when and how to take the first picture from [Now] , [Self-timer] , [Remote Control] , or [Set Time] .
Start Time	Set the shooting start time when [Start Interval] is set to [Set Time] .
Composite Mode	Select from [Average] , [Additive] , or [Bright] (only for [Interval Composite]).
Save Process	Select <input checked="" type="checkbox"/> to save images in the middle of processing (only for [Interval Composite]).
Fade-out	Select the fade-out effect level of light trails (only for [Star Stream]).

- 5 Press **OK**.
The screen of Step 1 reappears.
- 6 Press **OK**.
The camera returns to standby mode.
- 7 Press **SHUTTER**.
When **[Start Interval]** is set to **[Now]**, the first picture is taken. When set to **[Set Time]**, shooting starts at the set time.
To cancel shooting, turn the main switch to **[OFF]**.
After the specified number of shots are taken, the camera returns to standby mode.

Memo

- For **INT** and , a new folder is created and the captured images are saved there.
- The shortest time that can be set for [Interval] is 5 seconds when [Digital Filter], [Clarity], or [Skin Tone] is set, and 10 seconds when [HDR Capture] is set.
- The second and later exposures start at the intervals set in [Interval]. If the exposure time is longer than the time set in [Interval], some of the pictures that are supposed to be taken at the set intervals are not actually taken. For example, if the time set in [Interval] is 2 seconds and the exposure time is 3 seconds, the first exposure does not end at the time the second exposure is supposed to start (2 seconds after the start of shooting), and so the second picture is not taken. As a result, Interval Shooting ends before the specified number of shots are taken. In such cases, you can set [Standby Interval] in [12 Interval Shooting Options] of the **C2** menu so that pictures are taken at the set intervals after each exposure ends. The screen displayed in Step 4 varies depending on the [12 Interval Shooting Options] setting.
- For **INT** and , the focus position used when the first picture is taken is locked. In order to perform autofocus for each exposure, set [13 AF in Interval Shooting] to [Adjusts focus for each shot] in the **C2** menu.
- For  and , set the camera on a fixed support such as tripods during shooting.
- For , [Shake Reduction] of the **4** menu is fixed to [Off].



Setting the White Balance

1 Press in standby mode.











The White Balance setting screen appears.

Press **Fx1** to use Digital Preview when shooting with the viewfinder.

2 Select the desired white balance setting.

For , , and **K**, turn  to select the type of white balance.



	Auto White Balance
	Multi Auto White Balance
	Daylight
	Shade
	Cloudy
	Fluorescent - Daylight Color
	Fluorescent - Daylight White
	Fluorescent - Cool White
	Fluorescent - Warm White
	Tungsten
CTE	Color Temperature Enhancement
	Manual White Balance 1 to 3
K	Color Temperature 1 to 3

Available operations when shooting with the viewfinder

-  Saves the preview image (only when the image can be saved).



Proceed to Step 5 if you do not need to fine-tune the white balance.

3 Press **INFO**.

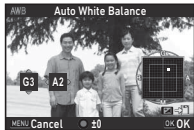
The fine-tuning screen appears.



Available operations

-  Adjust: Green-Magenta
-  Adjust: Blue-Amber
-  Resets the adjustment value to the default setting.

4 Press **OK**.

The screen of Step 2 reappears.



5 Press **OK**.

The camera returns to standby mode.

Caution

- The Digital Preview operation in Step 1 is disabled when the drive mode is set to [Mirror Lock-up Shooting], [Multi-exposure], or [Interval Shooting].

Memo

- When  is set, even if various light sources are present at the shooting location, the camera automatically adjusts the white balance according to the light source of each area. ( is not available in  mode.)
- The following settings for the white balance can be set in the **C2-3** menus.

14 WB Adjustable Range	Fixed, Auto Adjustment
15 AWB in Tungsten Light	Strong Correction, Subtle Correction
16 WB When Using Flash	Auto White Balance, Multi Auto White Balance, Unchanged
17 Color Temperature Steps	Kelvin, Mired

Adjusting the White Balance Manually

You can measure the white balance at a selected location.

1 Select  in Step 2 of “Setting the White Balance” (p.72).

2 Use  to select 1 to 3.

1 to 3 are the locations where you can store three different manual white balance settings.

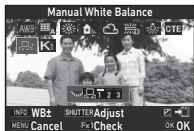

3 Under the light you wish to measure the white balance of, select a white area as the subject, and press **SHUTTER** fully.

The captured image is displayed.

4 Use     to specify the measuring area.

Press  to return the measuring area to the center.





5 Press **OK**.

The White Balance setting screen reappears.

[The operation could not be completed correctly] appears when measuring is unsuccessful. Press **OK** to remeasure the white balance.

Memo

- You can copy the white balance settings of a captured image and save them as  1 to  3 in [Save as Manual WB] of the playback mode palette. (p.83)

Adjusting the White Balance with Color Temperature

Specify the white balance with the color temperature.

1 Select **K** in Step 2 of “Setting the White Balance” (p.72).

2 Use  to select 1 to 3.

3 Press **INFO**.

4 Adjust the color temperature.

Set the color temperature value within the range from 2,500K to 10,000K.

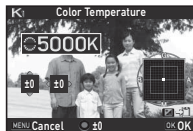

Available operations



Changes the color temperature in increments of 100 Kelvin.



Changes the color temperature in increments of 1,000 Kelvin.





Fine-tunes the color temperature.

5 Press **OK**.

The White Balance setting screen reappears.

Memo

- Select [Mired] in [17 Color Temperature Steps] of the **C3** menu to set the color temperature in mired units. The color temperature can be changed in 20 mired units with , and 100 mired units with . However, figures are converted to and displayed in Kelvin.

Controlling the Image Finishing Tone

When you want to take pictures with a slightly different style, you can set the desired picture style before shooting. Try out the various settings, and find your best picture style.

Custom Image



1 Select [Custom Image] in 1 or 1 menu and press **▶**.

The Custom Image setting screen appears.

2 Select an image finishing tone.

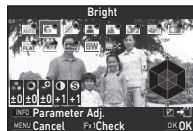

Auto Select
Bright
Natural
Portrait
Landscape
Vibrant
Radiant

Muted
Flat
Bleach Bypass
Reversal Film
Monochrome
Cross Processing

Available operations when shooting with the viewfinder

- Fx1** Uses Digital Preview to preview the background image with the selected setting applied.

- F2** Saves the preview image (only when the image can be saved).

Proceed to Step 6 if you do not need to change the parameters.

3 Press **INFO.**

The parameter setting screen appears.

4 Set the parameters.**Available operations**

- ▲▼** Selects a parameter.

- ◀▶** Adjusts the value.

- ☀** Switches between [Contrast], [Highlight Adjustment], and [Shadow Adjustment].

- ☀** Switches between [Sharpness], [Fine Sharpness], and [Extra Sharpness]. (Not available in **📷** mode.)

- Resets the adjustment value to the default setting.

5 Press **MENU.**

The screen of Step 2 reappears.

The adjustment values for parameters are displayed.

6 Press **MENU twice.**

The camera returns to standby mode.

⚠ Caution

- In **AUTO** mode, the image finishing tone is fixed to [Auto Select].
- The Digital Preview operation in Step 2 is disabled when the drive mode is set to [Mirror Lock-up Shooting], [Multi-exposure], or [Interval Shooting].

Saving the Cross Processing Settings of a Captured Image

When [Cross Processing] is set to [Random], the outcome varies each time a picture is taken. If you take a cross processed image that you like, you can save the Cross Processing settings used in the image so that you can repeatedly use the same settings.

1 Press **▼ in single image display of playback mode.**

The playback mode palette appears.

2 Select **📷 and press **OK**.**

The camera searches for cross processed images starting from the most recent image taken.

[No cross processed image] appears if there are no cross processed images.

- 3** Use  to select a cross processed image.

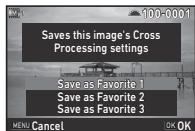



- 4** Select the “Favorite” number 1, 2, or 3 to save the settings, and press **OK**.
The settings of the selected image are saved as your “Favorite” settings.

Memo

- The saved Cross Processing settings can be loaded by selecting [Cross Processing] in Step 2 of “Custom Image” (p.75), and selecting one of the Favorite settings 1 to 3 for the parameter.

Digital Filter



- 1** Select [Digital Filter] in  or  menu and press **▶**.
The Digital Filter setting screen appears.

- 2** Select a filter.



Select [No Filter] to not shoot with a digital filter.



Extract Color
Replace Color
Toy Camera
Retro
High Contrast

Shading
Invert Color
Unicolor Bold
Bold Monochrome

Available operations when shooting with the viewfinder

-
-  Uses Digital Preview to preview the background image with the selected setting applied.
-
-  Saves the preview image (only when the image can be saved).
-

Proceed to Step 6 if you do not need to change the parameters.

- 3** Press **INFO**.
The parameter setting screen appears.

4 Set the parameters.



Available operations

- ▲▼ Selects a parameter.
- ◀▶ Adjusts the value.

5 Press **OK**.

The screen of Step 2 reappears.

6 Press **OK**.

7 Press **MENU**.

The camera returns to standby mode.

⚠ Caution

- This function cannot be used in some capture modes or in combination with some other functions. (p.118)
- The Digital Preview operation in Step 2 is disabled when the drive mode is set to [Mirror Lock-up Shooting], [Multi-exposure], or [Interval Shooting].
- Depending on the filter used, it may take longer to save images.

📄 Memo

- Still images can also be processed with digital filters in playback mode. (p.89)

Correcting Images

Brightness Adjustment

Highlight Correction Shadow Correction



Expands the dynamic range and enables a wider range of tones to be recorded by the CMOS sensor and reduces the occurrence of overexposed/underexposed areas. Set the correction functions from [D-Range Settings] of the or menu.



⚠ Caution

- When the sensitivity is set to less than ISO 200, [Highlight Correction] cannot be set to [On].

📄 Memo

- [Highlight Correction] in mode can be set to [Auto] or [Off].

HDR Capture



Takes three consecutive images at three different exposure levels to create a single composite image with them.

1 Select **[HDR Capture]** in **☷3** menu and press **▶**.
The **[HDR Capture]** screen appears.

2 Select the capture type and press **OK**.

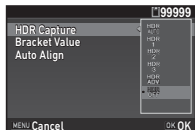

3 Set the range in which to change the exposure in **[Bracket Value]**.

Select from **[±1EV]**, **[±2EV]**, or **[±3EV]**.

4 Set whether to use **Auto Align** or not.

<input checked="" type="checkbox"/>	Uses Auto Align.
<input type="checkbox"/>	Does not use Auto Align.

5 Press **MENU** twice.

The camera returns to standby mode.

⚠ Caution

- This function cannot be used in some capture modes or in combination with some other functions. (p.118)
- When **[SCN]** of **SCN** mode is selected, **[HDR Capture]** is fixed to **[HDR AUTO]**.
- When the drive mode is set to **[Interval Shooting]** or **[Interval Movie Record]**, **[Auto Align]** is fixed to (Off).
- When **[Auto Align]** is set to (Off), **[Shake Reduction]** of the **☷4** menu is fixed to **[Off]**.
- For HDR Capture, multiple images are combined together to create a single image, so it may take time to save the image.

Lens Correction



The following features can be set in [Lens Correction] of the 4 menu.

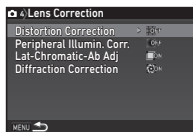

Distortion Correction	Reduces distortions occurring due to lens properties.
Peripheral Illumin. Corr.	Reduces peripheral light fall-off occurring due to lens properties.
Lat-Chromatic-Ab Adj	Reduces lateral chromatic aberrations occurring due to lens properties.
Diffraction Correction	Corrects blur caused by diffraction when using a small aperture.

Memo

- Corrections can only be made when a compatible lens is attached. (p.121) The features are disabled when using an accessory such as rear converters that is attached between the camera and the lens.
- When [File Format] is set to [RAW] or [RAW+] in [Image Capture Settings] of the 2 menu, correction information is saved as a RAW file parameter and you can select whether to apply the correction to the images when developing them. For the RAW Development function, [Color Fringe Correction] can also be set. (p.92)

Quality Level and Texture Adjustment

Clarity



By using an image processing function, the texture and surface details can be adjusted in the range of -4 to +4.

Set in [Clarity] of the 3 menu.

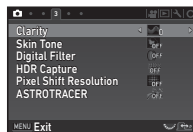

Skin Tone



The skin tone of portraits can be enhanced.

Select [Type1] or [Type2] in [Skin Tone] of the 3 menu.



Type1	Determines the skin tone of the subject by the Face Detection function, and creates a natural-looking skin tone. (Available only when the subject's face can be detected.)
Type2	Softens the entire image and makes skin irregularities less noticeable.

Pixel Shift Resolution



Pixel Shift Resolution is the feature that enables outputting a high-definition image of a stationary object by merging four images shifted pixel by pixel using the Shake Reduction mechanism.

Set in [Pixel Shift Resolution] of the 3 menu.

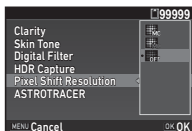

Motion Correction On	Corrects mosaic-pattern noise when a moving object is detected, and creates a composite image.
Motion Correction Off	Creates a composite image by combining the entire range of image.
Off	Does not use Pixel Shift Resolution.

When shooting is performed, the four images are displayed in turn, and then they are merged into a single image.

Caution

- This function cannot be used in some capture modes or in combination with some other functions. (p.118)
- While this function is used, [AA Filter Simulator] and [Shake Reduction] of the 4 menu are fixed to [Off].

Memo

- If a moving object exists in the frame, mosaic-pattern noise may appear in the image. In such case, select [Motion Correction On].
- When taking pictures with Pixel Shift Resolution, use a tripod and mount the camera on it securely. The use of Self-timer, Remote Control, or Mirror Lock-up Shooting is recommended.

Anti-Aliasing Filter Simulator



By shaking the Shake Reduction unit, a moiré reduction effect simulating that of a low-pass filter can be achieved.



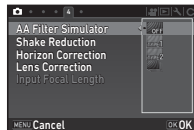

1 Select [AA Filter Simulator] in 4 menu and press .

2 Select a type and press **OK**.





Type1	Takes pictures while balancing the resolution and moiré reduction.
Type2	Prioritizes the moiré reduction.
Bracketing	Takes consecutive 3 images in order of [Off], [Type1], and [Type2].

⚠ Caution









- This function cannot be used in some capture modes or in combination with some other functions. (p.118)
- [Bracketing] cannot be selected in the following situations.
 - When , , or  of **SCN** mode is selected
 - In **B** mode
- [Bracketing] cannot be used when the drive mode is set to other than [Single Frame Shooting], [Self-timer] (12 seconds, 2 seconds), or [Remote Control] (now, after 3 seconds).
- When [HDR Capture] in the 3 menu is set, [AA Filter Simulator] is fixed to [Off].
- When the shutter speed is faster than 1/1000 seconds, the full effect of this function cannot be achieved.



Playback Mode Palette Items

Playback functions can be set from the playback mode palette as well as the  menu (p.30).

Press  in single image display (Standard Information Display or No Information Display) of the playback mode to display the playback mode palette.



Item	Function	Page
 Image Rotation *1	Changes the rotation information of images.	p.86
 Digital Filter *1	Processes images with digital filters.	p.89
 Color Moiré Correction *1 *2	Reduces color moiré in images.	p.89
 Resize *1 *2	Changes the number of recorded pixels of the image.	p.88
 Cropping *1	Crops out only the desired area of an image.	p.88
 Protect	Protects images from being accidentally erased.	p.114
 Slideshow	Plays back images one after another.	p.86
 Save as Manual WB *1	Saves the white balance settings of the captured image as Manual White Balance.	p.74

Item	Function	Page
 Save Cross Processing	Saves the settings used for an image captured in Cross Processing mode of Custom Image as your "Favorite" settings.	p.76
 RAW Development *3	Develops RAW images into JPEG images and saves them as new files.	p.92
 Movie Edit *4	Divides a movie or deletes unwanted segments.	p.91

*1 Not available when a movie is displayed.

*2 Not available when a RAW image is displayed.

*3 Available only if a RAW image has been saved.

*4 Available only when a movie is displayed.

Changing the Playback Method

Displaying Multiple Images

You can display 6, 12, 20, 35, or 80 thumbnail images at the same time.

- 1** Turn  to the left in playback mode.

The multi-image display screen appears.



Available operations

 Moves the selection frame.

 Shows the next/previous page.

 Shows the display style selection screen.



 Deletes the selected images.

- 2** Press **OK**.

The selected image appears in single image display.

Deleting Selected Images

- 1** Press  in Step 1 of “Displaying Multiple Images” (p.84).
- 2** Select the images to delete.





Available operations

 Moves the selection frame.

 Confirms/cancels the selection of the image to delete.

 Selects the range of images to delete.

 Shows the selected image in single image display.
Use  to select a different image.

In the upper left area of the monitor, the number of selected images is displayed.

- 3** Press .
- The delete confirmation screen appears.

- 4** Select **[Delete]** and press **OK**.

Memo



- You can select up to 500 images at a time.
- Protected images cannot be selected.
- You can delete the images selected individually along with the images selected by specifying the range to delete.
- Use the same steps to select multiple images for the following functions.
 - RAW Development (p.92)
 - Protect (p.114)

Displaying Images by Folder

- 1 Turn  to the left in Step 1 of “Displaying Multiple Images” (p.84).
The folder display screen appears.



Available operations

-
-  Moves the selection frame.
-
-  Deletes the selected folder.
-

- 2 Press **OK**.
The images in the selected folder are displayed.

Deleting a Folder

- 1 Select the folder to delete in Step 1 of “Displaying Images by Folder” (p.85), and press .
The delete confirmation screen appears.
- 2 Select [Delete] and press **OK**.
The selected folder and all the images in it are deleted. When there are protected images in the folder, select [Delete all] or [Leave all].



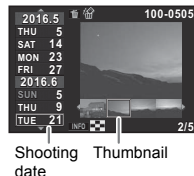

Displaying Images by Shooting Date

Images are grouped and displayed by shooting date.

- 1 Press **INFO** in Step 1 of “Displaying Multiple Images” (p.84).
The display style selection screen appears.
- 2 Select [Calendar Filmstrip Display].



Available operations

-
-  Selects a shooting date.
-
-  Selects an image taken on the selected shooting date.
-
-  to the right Shows the selected image in single image display.
-
-  Deletes the selected image.
-

- 3 Press **OK**.
The selected image appears in single image display.



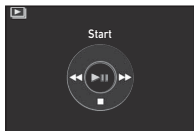

Playing Back Images Continuously (Slideshow)

- 1 Select  in the playback mode palette.

A slideshow starts.



Available operations

	Pauses/resumes playback.
	Displays the previous image.
	Displays the next image.
	Stops playback.
	Adjusts the sound volume of the movie.

After all images are played back, the camera returns to single image display mode.

Memo

- You can change the [Display Duration], [Screen Effect], [Repeat Playback], and [Auto Movie Playback] settings for a slideshow in [Slideshow] of the  1 menu. A slideshow can also be started from the Slideshow setting screen.

When [Auto Movie Playback] is set to (Off), press **OK** during a slideshow to play back a movie.

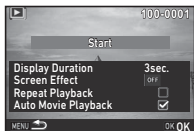

Displaying Rotated Images





Image rotation information is saved when you take pictures with the camera held vertically. When [Auto Image Rotation] of [LCD Display] in the  1 menu is set to (On), the image is automatically rotated based on the rotation information during playback (default setting).

The rotation information of an image can be changed by following the procedure below.

- 1 Display the image to edit in single image display.

- 2 Select  in the playback mode palette.

The selected image is rotated in 90° increments and the four thumbnail images are displayed.

- 3 Use     to select the desired rotation direction and press **OK**.

The image rotation information is saved, and the camera returns to single image display mode.



Caution

- When [20 Save Rotation Info] is set to [Off] in the **C3** menu, image rotation information is not saved.
- You cannot change image rotation information in the following cases.
 - Protected images
 - Images without a rotation information tag
- When [Auto Image Rotation] of [LCD Display] in the  1 menu is set to (Off)
- Movie files cannot be rotated.

Connecting the Camera to an AV Device

Connect to an AV device, such as TVs, equipped with an HDMI terminal to display Live View images while shooting or to play back images in playback mode.

Make sure to have a commercially available HDMI cable equipped with an HDMI terminal (type D).

- 1 Turn the AV device and camera off.
- 2 Open the terminal cover of the camera, and connect the cable to the HDMI terminal.

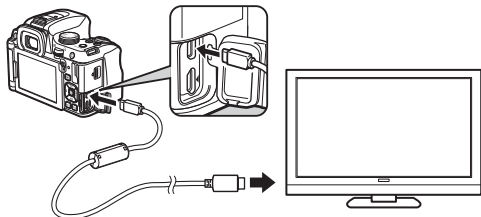

- 3 Connect the other end of the cable to the input terminal on the AV device.
- 4 Turn the AV device and camera on.
The camera turns on in HDMI mode, and the camera information is displayed on the screen of the connected AV device.

Caution

- While the camera is connected to an AV device, nothing is displayed on the camera monitor. Also, you cannot adjust the sound volume on the camera. Adjust the volume on the AV device.

Memo

- Check the operating manual of the AV device and select a suitable input terminal for connecting the camera.
- By default, the maximum resolution supported by both the AV device and camera is automatically selected. If it fails to play back images properly, change the setting in [HDMI Out] of the **3** menu.
- If you intend to use the camera continuously for a long period, the use of the optional AC adapter kit is recommended. (p.39)

Editing and Processing Images

Changing the Image Size

⚠ Caution

- Only JPEG images captured with this camera can be resized or cropped.
- Images already resized or cropped to the minimum file size cannot be processed.

Changing the Number of Recorded Pixels (Resize)

Changes the number of recorded pixels of the selected image, and saves it as a new file.

1 Display the image to edit in single image display.

2 Select in the playback mode palette.

The screen to select the number of recorded pixels appears.

3 Use to select the number of recorded pixels and press **OK**.

You can select an image size smaller than that of the original image.

The save confirmation screen appears.



4 Select **[Save]** and press **OK**.

Cropping Out Part of the Image (Cropping)

Crops out only the desired area of the selected image and saves it as a new file.

1 Display the image to edit in single image display.

2 Select in the playback mode palette.

The cropping frame to specify the size and position of the area to crop appears on the screen.

3 Specify the size and position of the area to crop by using the cropping frame.



Available operations



Changes the size of the cropping frame.



Moves the cropping frame.



Changes the Aspect Ratio or Image Rotation setting.



Rotates the cropping frame (only when possible).

4 Press **OK**.

The save confirmation screen appears.

5 Select **[Save]** and press **OK**.

Correcting Color Moiré

Reduces color moiré in images.

1 Display the image to edit in single image display.

2 Select  in the playback mode palette.
If the image cannot be edited, [This image cannot be processed] appears.

3 Use   to select the correction level and press .

The save confirmation screen appears.



4 Select [Save] and press .

Caution

- The Color Moiré Correction function can be used only for the JPEG images captured with this camera.

Processing Images with Digital Filters

1 Display the image to edit in single image display.

2 Select  in the playback mode palette.
The screen to select a filter appears.

3 Select a filter.
Use  to select a different image.



Base Parameter Adj	Sketch
Extract Color	Water Color
Replace Color	Pastel
Toy Camera	Posterization
Retro	Miniature
High Contrast	Soft
Shading	Starburst
Invert Color	Fish-eye
Unicolor Bold	Slim
Bold Monochrome	Monochrome
Tone Expansion	

Proceed to Step 7 if you do not need to change the parameters.

4 Press .

The parameter setting screen appears.

5 Set the parameters.

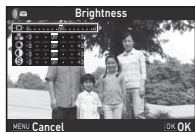

Available operations

- ▲▼ Selects a parameter.
- ◀▶ Adjusts the value.

6 Press **OK**.

The screen of Step 3 reappears.

7 Press **OK**.

The save confirmation screen appears.

8 Select **[Apply additional filter(s)]** or **[Save]** and press **OK**.

Select **[Apply additional filter(s)]** when you want to apply additional filters to the same image. The screen of Step 3 reappears.

⚠ Caution

- Only JPEG and RAW images captured with this camera can be edited with the digital filters.
- RAW images captured using HDR Capture or Pixel Shift Resolution cannot be processed with Digital Filter.

📝 Memo

- Up to 20 filters, including the digital filter used during shooting (p.77), can be applied to the same image.

Recreating Filter Effects

Retrieves the filter effects of the selected image and applies the same filter effects to other images.

1 Display a filter-processed image in single image display.

2 Select **[Filter]** in the playback mode palette.

3 Select **[Recreating filter effects]** and press **OK**.

The filter effects used for the selected image appear.



4 To check the parameter details, press **INFO**.

Press **INFO** again to return to the previous screen.



5 Press **OK**.

The image selection screen appears.

6 Use **[Filter]** to select an image for applying the same filter effects, and press **OK**.

You can only select an image that has not been processed with a filter.

The save confirmation screen appears.



7 Select **[Save]** and press **OK**.

Memo

- If [Searching for original image] is selected in Step 3, the original image prior to digital filter application can be retrieved.

Editing Movies

1 Display the movie to edit in single image display.

2 Select  in the playback mode palette.
The movie editing screen appears.





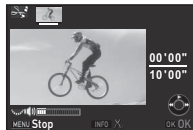

3 Select the point where you want to divide the movie.

The frame at the dividing point is displayed at the top of the screen.

Up to four points can be selected to divide the original movie into five segments.



Available operations

	Plays back/pauses a movie.
	Forwards a frame (when paused).
Press and hold 	Fast-forwards playback.
	Reverses a frame (when paused).
Press and hold 	Fast-reverses playback.
	Adjusts the sound volume.
	Confirms/cancels the selected dividing point.

Proceed to Step 7 if you do not want to delete any segment.

4 Press .

The screen to select the segments to delete is displayed.

- 5** Use ◀▶ to move the selection frame and press **OK**.

The segments to delete are specified. (Multiple segments can be deleted at once.)

Press **OK** again to cancel the selection.

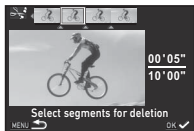

- 6** Press **MENU**.

The screen of Step 3 reappears.

- 7** Press **OK**.

The save confirmation screen appears.

- 8** Select **[Save]** and press **OK**.

● Memo

- Select dividing points in chronological order from the beginning of the movie. When canceling the selected dividing points, cancel each of them in reverse order (from the end of the movie to the beginning). In an order other than specified, you can neither select dividing points nor cancel the selections of the dividing points.

Developing RAW Images

You can develop RAW images into JPEG images, and save them as new files.

- 1** Select **RAW** in the playback mode palette.

The screen for selecting the processing type appears.

- 2** Select the desired option and press **OK**.

Select single image	Develops an image.
Select multiple images	Develops up to 500 images with the same settings.
Select a folder	Develops up to 500 images in the selected folder with the same settings.

When [Select single image] is selected, proceed to Step 6. The image/folder selection screen appears.

- 3** Select **image(s)** or a **folder**.

Refer to Step 2 of “Deleting Selected Images” (p.84) for how to select image(s).

Proceed to Step 5 if a folder is selected.

- 4** Press **INFO**.

The screen for selecting the parameter setting method appears.

- 5** Select the parameter setting method and press **OK**.



Develop images as shot	Allows you to change only Aspect Ratio, JPEG Recorded Pixels, JPEG Quality, and Color Space.
Develop images with modified settings	Allows you to change all setting items.

- 6** Select the setting item to change.



White Balance	Distortion Correction
Custom Image	Peripheral Illumin. Corr.
Sensitivity	Lat-Chromatic-Ab Adj
Clarity	Diffraction Correction
Skin Tone	Color Fringe Correction
Digital Filter	Aspect Ratio
HDR Capture/	JPEG Recorded Pixels
Pixel Shift Resolution	JPEG Quality
Shadow Correction	Color Space
High-ISO NR	

Available operations

	Selects a different image (when in single image display).
	Selects a setting item.
	Changes the value.
INFO	Reviews the image.
OK	Makes detailed settings.

- 7** Use **▲▼◀▶** to select **[JPEG→]** and press **OK**.
The save confirmation screen appears.

- 8** Select **[Save]** and press **OK**.
When [Select single image] is selected, select [Continue] or [Exit], and press **OK**.

⚠ Caution

- Only RAW images captured with this camera can be developed.
- For RAW images captured when the drive mode is set to [Multi-exposure] or [Interval Composite], the Lens Correction features cannot be used.

📌 Memo

- When [Select multiple images] or [Select a folder] is selected in Step 2, a folder with a new number is created, and the JPEG images are stored in it.
- For [HDR Capture] and [Pixel Shift Resolution], the parameters of either one of the two functions used during shooting can be changed.
- With the provided software "Digital Camera Utility 5", you can develop RAW images on a computer.

Copying an Image to a Computer

Connect the camera to a computer using a USB cable. Make sure to have a commercially available USB cable equipped with a micro B terminal.

- 1 Turn the computer on.
- 2 Turn the camera off.
- 3 Open the terminal cover of the camera, and connect the USB cable to the USB terminal.

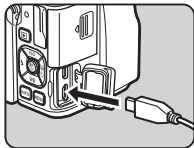

- 4 Connect the USB cable to the USB port of the computer.
- 5 Turn the camera on.
The camera is recognized as a removable disk.
- 6 Save the captured images to the computer.
- 7 Disconnect the camera from the computer.

⚠ Caution

- The camera cannot be operated while it is connected to a computer. To operate the camera, terminate the USB connection on the computer first, then turn off the camera and remove the USB cable.
- If the "K-70" dialog appears on the computer screen in Step 5, select [Open folder to view files] and click the OK button.

📄 Memo

- Refer to "Operating Environment for USB Connection and Provided Software" (p.139) for system requirements to connect the camera to a computer with a commercially available USB cable and to use the software.
- The USB connection mode when connecting the camera to a computer can be set in [USB Connection] of the 3 menu. Normally, you do not need to change the default setting ([MSC]).
- If you intend to use the camera continuously for a long period, the use of the optional AC adapter kit is recommended. (p.39)



Using the Camera with a Communication Device

This camera has a built-in Wi-Fi function. By directly connecting to a communication device such as smartphones and tablets via wireless LAN, the camera can be operated from the communication device and images can be shared with others via social networks or e-mail.

Enabling the Wi-Fi Function

The Wi-Fi function is disabled when the camera is turned on. Enable the function using one of the following methods.

- Setting from the menus (p.96)
- Using the **Wi-Fi** button (p.96)

When the Wi-Fi function is enabled, a beep sounds and the  (white) icon indicating the wireless LAN status is displayed on the status screen and Live View screen. When  (gray) is displayed, a connection with the communication device is not established correctly.



Memo

- Even after the Wi-Fi function is enabled, it returns to an inactive state when the camera is turned off and on again. Also, when the camera enters  mode, the Wi-Fi function is disabled.
- Auto Power Off is not available while a Wi-Fi connection is established or images are being transferred. If Auto Power Off is activated while a connection is not established, the Wi-Fi function is disabled. The function is enabled when the camera recovers from Auto Power Off.
- The Wi-Fi function is disabled during the USB connection.

Caution

- Do not attempt to use the Wi-Fi function in a location where the use of wireless LAN devices is restricted or prohibited, such as on airplanes.
- When using the Wi-Fi function, observe local laws and regulations governing radio communication.
- If a memory card with a built-in wireless LAN function (such as an Eye-Fi card or a Flucard) is used, radio wave interference may occur. When this occurs, disable the Wi-Fi function of the camera.

Setting from the Menu

**1** Select [Wi-Fi] in 3 menu and press **▶**.

The [Wi-Fi] screen appears.

2 Set [Action Mode] to [On].

Select [Off] to disable the Wi-Fi function.

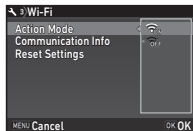
**3** Press **MENU** twice. **Memo**

- In Step 2, select [Communication Info] to check the SSID, Password, and MAC Address of the wireless LAN. Or, select [Reset Settings] to reset the settings to their default values.

Using the **Fx2** Button**1** Press and hold **Fx2** in single image display of the playback mode.

A beep sounds and [Wi-Fi enabled] appears on the monitor.

Press and hold **Fx2** again to disable the Wi-Fi function.

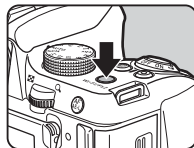
 **Caution**

- By default, you can turn the Wi-Fi function on and off by pressing and holding **Fx2**. If the **Fx2** button function is changed in [Button Customization] of the 5 menu, you cannot turn the Wi-Fi function on and off with **Fx2** (p.106).

Operating the Camera with a Communication Device

The following functions can be used by connecting the camera to a communication device via Wi-Fi and using the dedicated application “Image Sync”.

Remote Capture	Displays the Live View image of the camera on the communication device, and enables controlling exposure settings and shooting by operating the communication device.
Image View	Displays the images saved on the memory card inserted in the camera on the communication device and imports the images to the communication device.

Image Sync supports iOS and Android, and can be downloaded from the App Store or Google Play. For supported OS and other details, refer to the download site.

Memo

- The Image Sync screenshots used in this manual are the ones under development and may differ from the actual display. The screen layout and elements may be also changed due to causes such as the version upgrade of the application.
- For details on how to operate the communication device, refer to the operating manual of the device.

Connecting the Camera and a Communication Device

Connect the camera and a communication device via Wi-Fi, and start Image Sync installed on the communication device.

When an Android Device is Used

- 1 Set the wireless LAN (Wi-Fi) function to ON on the communication device.**
- 2 Start Image Sync on the communication device.**
The camera selection screen appears on the communication device.
- 3 Tap [PENTAX K-70].**
The [Choose a Network] screen appears on the communication device.



4 Tap [PENTAX_xxxxxx] in the [Network List].

The [Enter Password] screen appears.



5 Enter the password, and tap [Connect].

A Wi-Fi connection is established between the camera and the communication device.

The list of images appears on the Image Sync screen.

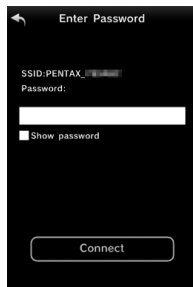

Memo

- Refer to [Communication Info] in [Wi-Fi] of the  3 menu for the default password. (p.96)

When an iOS Device is Used

1 Set the wireless LAN (Wi-Fi) function to ON on the communication device.

2 Tap [PENTAX_xxxxxx] in the list of detected Wi-Fi networks.

3 Enter the password, and tap [Join].

A Wi-Fi connection is established between the camera and the communication device.



4 Start Image Sync on the communication device. Image Sync is started, and the list of images appears.

Screens of Image Sync

Flick left or right on the screen to change screens.

Application image list



Camera image list

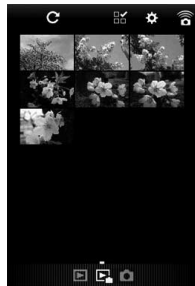

Camera mode



Memo

- You can change operation modes also by tapping the buttons displayed at the bottom of each screen.

Shooting with a Communication Device

The Live View image of the camera and buttons for shooting are displayed on the shooting screen of Image Sync.

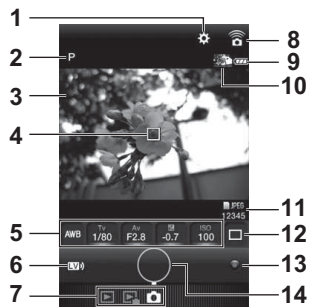

- Settings (p.104)
- Capture mode
- Live View
- AF frame
- White Balance, Shutter Speed, Aperture value, EV Compensation, Sensitivity
- Live View on/off
- Operation modes
- Communication icon
- Battery level
- Thumbnail of the last captured image
(When tapped, the camera image list is displayed.)
- File Format, Image storage capacity
- Drive Mode
- Green button
- Shutter release button

1 Set up the basic settings on the camera.

2 Check the Live View image on the shooting screen of Image Sync.



3 Change the settings using Image Sync as necessary.

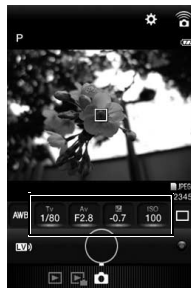

Tap an item and select a value from the list.



4 When the focus method is set to **AF**, tap the position where you want to perform autofocus in the Live View image.

Autofocus is performed at the tapped position.

5 Tap the shutter release button.

The captured image is displayed as a thumbnail.

Caution

- Shooting with Image Sync is not available in the following situations.
 - In  mode
 - When the drive mode is set to other than [Single Frame Shooting]
 - When the camera is connected to a device via USB or HDMI terminal
 - When using the ASTROTRACER function
- The captured images are saved to the memory card inserted in the camera. Shooting cannot be performed if there is not enough available space on the memory card.

Memo

- Shooting can also be performed by tapping the Live View image.
Set in [Touch AF] on the [Settings] screen. (p.104)
- While shooting with Image Sync, the shutter release always has priority regardless of the [AF.S Setting] setting of [AF with Live View] in the 1 menu. (p.63)

Viewing Images

You can view the images saved either in the camera or in the communication device.

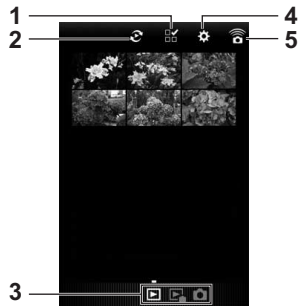

- 1 Multiple image selection button
- 2 Album selector button (available for the application image list only)
- 3 Operation modes
- 4 Settings (p.104)
- 5 Communication icon

Tap the thumbnail image to view it in single image display and check its shooting information.



Touch operations

Flick left/right	Shows the previous/next image.
Pinch out/in	Magnifies/reduces the image.

Selecting the Image Storage Location

When viewing images in application image list display, you can select the image storage location (album) from “Application” or “Gallery” (or “Camera Roll”).

1 Tap .

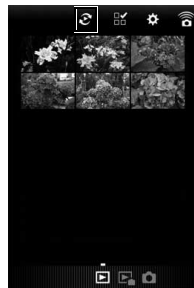

2 Select the album.

The images in the selected album are displayed.

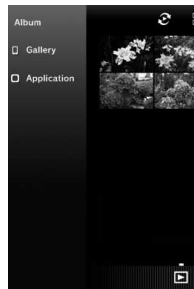

Selecting Multiple Images

1 Tap .

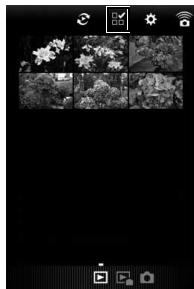

2 Tap the images to select.
Blue check marks appear.

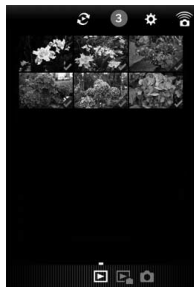

3 Touch and hold one of the selected images.

4 Select the desired action.

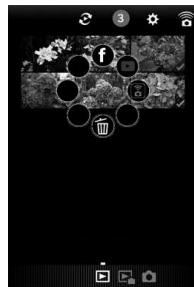

Memo

- When you touch and hold the desired image on the image list display screen or the shooting information display screen, the same screen as Step 4 appears and you can select the action to apply.

5

Sharing

Changing the Settings

1 Tap .



The [Settings] screen appears.

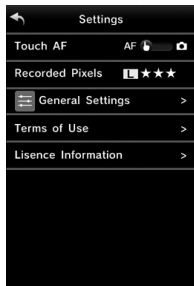

The following settings are available.

Touch AF	Sets whether to perform only autofocus or perform shooting after autofocus when touching the Live View image.
Recorded Pixels	Changes the settings for File Format and JPEG Recorded Pixels.
General Settings	Changes the communication settings and the display language.

2 Tap [General Settings] to change the communication settings and the display language.

3 Tap the setting item to be changed.

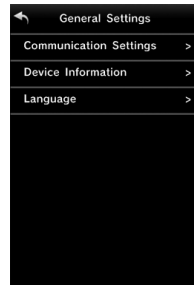

Communication Settings

The password and wireless channel can be changed.

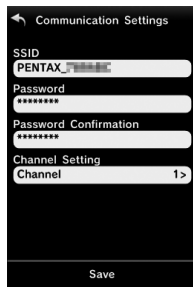

Device Information

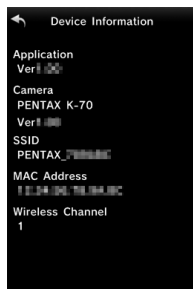

Language

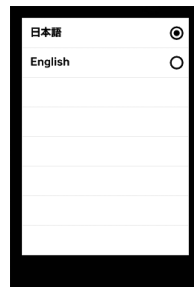

4 Change the settings and tap ←.

Camera Settings

Customizing the Button/E-dial Functions



Setting the Button Operation

You can set the functions for when **Fx1**, **Fx2**, or **AF/AE-L** is pressed. In **5** mode, you can set only the function for when **AF/AE-L** is pressed.

- 1 Select **[Button Customization]** in **5** or **2** menu and press **▶**.

The **[Button Customization]** screen appears.

- 2 Select the desired item and press **▶**.

The screen to set the function for the selected item is displayed.



- 3 Press **▶** and use **▲▼** to select the function to assign to each part.

The following functions can be assigned to each part.

	Setting	Function	Page
Fx1 Button Fx2 Button	One Push File Format	Temporarily changes the file format.	p.107
	Wi-Fi	Turns the Wi-Fi function on or off.	p.96
	Outdoor View Setting	Adjusts the brightness of the monitor for outdoor shooting.	p.110
	Night Vision LCD Display	Turns the Night Vision LCD Display on or off.	p.128
	Preview	Displays the preview image to check the composition, exposure, and focus before shooting.	p.108
	Electronic Level	Turns the Electronic Level display for the viewfinder and Live View on or off.	p.19
	Change AF Area	Switches the function of the arrow keys to the AF area change mode or the direct key operation mode.	p.63, p.64

	Setting	Function	Page
AF/AE-L Button	Enable AF1	Autofocus is performed when AF/AE-L is pressed.	p.61
	Enable AF2	Autofocus is performed when AF/AE-L is pressed. Half press of SHUTTER is disabled.	
	Cancel AF	While AF/AE-L is pressed, half press of SHUTTER is disabled.	
	AE Lock	Locks the exposure setting.	p.53

4 Press **OK**.

5 Press **MENU**.
The screen of Step 2 reappears.
Repeat Steps 2 to 5.

6 Press **MENU** twice.

Memo

- You can check the functions assigned to the buttons while the Guide Display (p.45) is shown.
- You can assign the same function to both **Fx1** and **Fx2**.
- When [AE Lock], [One Push File Format], [Wi-Fi], [Night Vision LCD Display], or [Electronic Level] is assigned to a button, pressing the button makes a beep sound. To disable the beep sound, change the sound setting for each function in [Sound Effects] of the  menu. (p.31)

Setting the One Push File Format

You can temporarily change the file format by pressing **Fx1** or **Fx2** during shooting. By default, [One Push File Format] is assigned to **Fx1**.

Select the file format to change to when **Fx1** or **Fx2** is pressed for each [File Format] setting.

1 Set [F_{x1} Button] or [F_{x2} Button] to [One Push File Format] in Step 3 of “Setting the Button Operation” (p.106).

2 Select or for [Cancel after 1 shot].

<input checked="" type="checkbox"/>	The recording format returns to the [File Format] setting of [Image Capture Settings] in the  2 menu after a picture is taken.
<input type="checkbox"/>	The setting is retained until any of the following operations is performed: <ul style="list-style-type: none"> • When Fx1 or Fx2 is pressed again • When ▶, MENU, or INFO is pressed, or when the mode dial or main switch is turned

3 Select the file format when **Fx1** or **Fx2** is pressed.

The left side is the [File Format] setting and the right side is the changed file format when **Fx1** or **Fx2** is pressed.

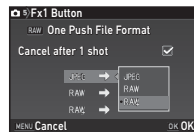

4 Press **MENU** three times.
The camera returns to standby mode.



Setting the Preview

You can display the preview image by pressing **Fx1** or **Fx2** before shooting.

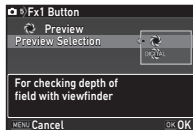

1 Set **[Fx1 Button]** or **[Fx2 Button]** to **[Preview]** in Step 3 of “Setting the Button Operation” (p.106).

2 Select a preview method in **[Preview Selection]** and press **OK**.



 Optical Preview	Activates the Optical Preview function to check the depth of field with the viewfinder.
 Digital Preview	Activates the Digital Preview function to check the composition, exposure, and focus on the monitor. You can magnify or save the preview image.

Proceed to Step 4 when  is selected.

3 Press **▼** and select  or  for each display item.

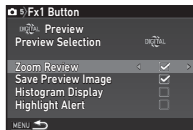

4 Press **MENU** three times.

The camera returns to standby mode.



Memo

- Optical Preview is always used in the following situations regardless of the setting.
 - When the drive mode is set to [Mirror Lock-up Shooting], [Multi-exposure], or [Interval Shooting]
 - When using the ASTROTRACER function
 - In  mode

Caution

- The effects of some functions cannot be checked during Digital Preview or are not applied to the saved preview image.

Setting the E-dial Operation

For each exposure mode, you can set the functions for when  and  are turned and  is pressed.







The function can be set for exposure modes other than **B** mode.

- 1 Select [E-Dial Programming] of [Button Customization] in  5 or  2 menu and press .



The [E-Dial Programming] screen appears.

- 2 Select an exposure mode and press .

The screen for the selected exposure mode appears.

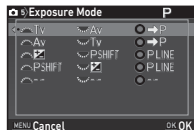
- 3 Press  and use   to select the combination of functions for when  and  are turned and  is pressed.



Tv	Change Shutter Speed
Av	Change Aperture Value
ISO	Change Sensitivity
	EV Compensation
 P	Return to P Mode
PSHIFT	Program Shift
PLINE	Program Line
--	Not available

- 4 Press **OK**.





- 5 Press **MENU**.

The [E-Dial Programming] screen reappears.

Repeat Steps 2 to 5.

- 6 Press **MENU** twice.

Memo

- If you select [Rotation Direction] in Step 2, you can reverse the effect obtained by turning  or .
- You can check the functions assigned to , , and  while the Guide Display (p.45) is shown.

Setting the Monitor and Indicator Lamps



LCD Display Settings

You can adjust the brightness, saturation, and color of the monitor.

- 1 Select [LCD Display Settings] in menu and press **▶**.

The [LCD Display Settings] screen appears.

- 2 Adjust the brightness, saturation, and color.

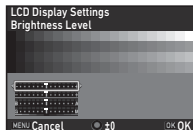

Available operations

- ▲▼ Selects a parameter.
- ◀▶ Adjusts the value.
- Resets the adjustment value to the default setting.

- 3 Press **OK**.

The menu reappears.

Outdoor View Setting

If the monitor display is difficult to see when you take pictures outdoors or in other situations, adjust the brightness of the monitor in [Outdoor View Setting] of the menu.

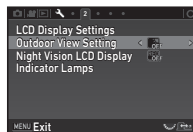

Memo

- When [Outdoor View Setting] is assigned to **Fx1** or **Fx2** in [Button Customization] of the menu, you can adjust the brightness of the monitor by a simple button operation. (p. 106)

Indicator Lamps

You can set whether to light up each indicator lamp in [Indicator Lamps] of the menu.

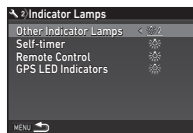

Other Indicator Lamps	High, Low, Off
Self-timer	On, Off
Remote Control	On, Off
GPS LED Indicators	On, Off

Saving Frequently Used Settings



Three factory preset settings—CLEAR TONE, HDR LANDSCAPE, and ASTROPHOTO—are assigned to **U1** to **U3** of the mode dial. You can save your favorite camera settings to **U1** to **U3** and replace the preset settings with them. The following settings can be saved.

Exposure Mode (P , Sv , Tv , Av , TV , M , B)	Drive Mode
Sensitivity	White Balance
EV Compensation	Custom Image
AF Active Area	 menu settings (with exceptions)
Flash Mode	C menu settings

Saving the Settings

- 1 Set the exposure mode and all the necessary settings to save.
- 2 Select **[Save USER Mode]** in  **5** menu and press **▶**.
The **[Save USER Mode]** screen appears.
- 3 Select **[Save Settings]** and press **▶**.
The **[Save Settings]** screen appears.
- 4 Select a **USER** mode from **[USER1]** to **[USER3]**, and press **▶**.



- 5 Select **[Save]** and press **OK**.

The screen of Step 3 reappears.

Caution

- **[Save USER Mode]** cannot be selected when the mode dial is set to **AUTO** or **SCN**.

Memo

- The settings saved as the USER mode can be displayed on the monitor when you select **[Check Saved Settings]** in Step 3.
- To reset the saved settings to their default values, select **[Reset USER Mode]** in Step 3.

Editing a Setting Name

You can change the name of the USER mode in which you saved settings.

- 1 Select **[Rename USER Mode]** in Step 3 of **“Saving the Settings”** (p.111) and press **▶**.
The **[Rename USER Mode]** screen appears.
- 2 Select a **USER** mode from **[USER1]** to **[USER3]**, and press **▶**.
The text-entry screen appears.

3 Change the text.

Up to 18 single-byte alphanumeric characters and symbols can be entered.

Text selection cursor

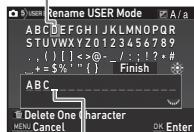

Text input cursor

Available operations



Moves the text selection cursor.



Moves the text input cursor.



Switches between upper and lower case letters.



Enters a character selected with the text selection cursor at the position of the text input cursor.



Deletes a character at the position of the text input cursor.

4 After entering the text, move the text selection cursor to [Finish], and press **OK**.

The [Rename USER Mode] screen reappears.

Using the Saved USER Mode

1 Set the mode dial to U1 to U3.

The USER mode name is displayed.

Use ▲▼ to check the saved settings.



2 Change the settings as necessary.

The exposure mode can be changed in [Exposure Mode] of the 1 menu.

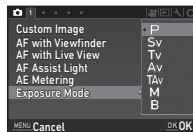

Memo

- The settings changed in Step 2 are not saved as the USER mode settings. When the camera is turned off, the camera returns to the saved USER settings. To change the saved settings, save the USER mode settings again.

Displaying the Local Date and Time of the Specified City

1

The date and time set at the time of initial setting ("Initial Settings" (p.42)) serve as the date and time of your present location and are reflected in the shooting date and time for images.

Setting the destination to a location other than your present location enables you to display the local date and time on the monitor when traveling abroad and also save images time-stamped with the local date and time.

1 Select [World Time] in 1 menu.

The [World Time] screen appears.

2 Select the time you wish to display in [Time Setting].

☰ (Hometown) or → (Destination) can be selected.

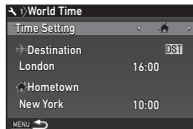

3 Select [→ Destination] and press ▶.

The [→ Destination] screen appears.

4 Use ◀▶ to select a city.

Use ☰ to change the region.

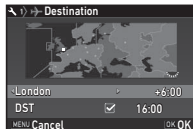

5 Select [DST] (daylight saving time), and use ◀▶ to select ☐ or ☑.

6 Press OK.

The screen of Step 2 reappears.

7 Press MENU twice.

Memo

- Refer to "List of World Time Cities" (p.138) for cities that can be selected as a hometown or destination.
- Select [☰ Hometown] in Step 3 to change the city and DST settings for the hometown.
- and the local date and time appear in the control panel when [Time Setting] is set to →.

Selecting Settings to Save in the Camera

5

The setting values for most functions of this camera are saved even if the camera is turned off. For the following function settings, you can select whether to save the settings (☑) or to return the settings to their default values (☐) when the camera is turned off.

Set in [Memory] of the 5 menu.

Sensitivity	Skin Tone
EV Compensation	Digital Filter
Flash Mode	HDR Capture
Flash Exposure Compensation	Pixel Shift Resolution
Drive Mode	Shooting Info Display
White Balance	Playback Info Display
Custom Image	Outdoor View Setting
Clarity	Night Vision LCD Display

Memo

- When [Reset] of the 5 menu is performed, all Memory settings return to the default values.

6

Settings

File Management Settings

Protecting Images from Deletion (Protect)

You can protect images from being accidentally deleted.

⚠ Caution

- Even protected images are deleted if the inserted memory card is formatted.

1 Select **☑** in the playback mode palette.

The screen for selecting the processing type appears.

2 Select [Select image(s)] or [Select a folder] and press **OK**.



3 Select the image(s) or folder to protect.

Refer to Step 2 of “Deleting Selected Images” (p.84) for how to select image(s).

Proceed to Step 5 if [Select a folder] is selected.

4 Press **INFO**.

The confirmation screen appears.

5 Select [Protect] and press **OK**.

📝 Memo

- To protect all images stored on the memory card, select [Protect All Images] of the **▶1** menu.

Selecting the Folder/File Settings



Create New Folder

When [Create New Folder] is selected in the menu, a folder is created with a new number when the next image is saved.

⚠ Caution

- You cannot successively create multiple folders.

📝 Memo

- A new folder is automatically created in the following cases.
 - When the drive mode is set to [Interval Shooting] (p.71)
 - When [Select multiple images] or [Select a folder] is selected for [RAW Development] of the playback mode palette (p.92)

Folder Name

When images are captured with this camera, a folder is automatically created and the captured images are stored in it. Each folder name consists of a sequential number from 100 to 999 and a string of 5 characters.

The character string in the folder name can be changed.

1 Select [Folder Name] in menu and press .

The [Folder Name] screen appears.

2 Press and select [Date] or [Optional].

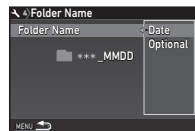

Date	The four digits of the month and day of the shooting date are assigned after the folder number. The month and day appear according to the date format set in [Date Adjustment]. Example) 101_0125: for images taken on January 25th
Optional	A freely defined string of five characters is assigned after the folder number. (Default setting: PENTX) Example) 101PENTX

Proceed to Step 6 if you select [Date] or do not need to change the character string.

3 Press , and then press .

The text-entry screen appears.

4 Change the text.



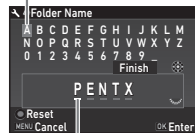

Enter five single-byte alphanumeric characters.

Text selection cursor



Text input cursor

Available operations

	Moves the text selection cursor.
	Moves the text input cursor.
	Enters a character selected with the text selection cursor at the position of the text input cursor.
	Resets the entered text to "PENTX".

5 After entering the text, move the text selection cursor to [Finish], and press **OK**.

6 Press **MENU** twice.

 **Memo**

- A folder with a new number is created when the folder name is changed.
- A maximum of 500 images can be stored in a single folder. When the number of captured images exceeds 500, a new folder is created with the number following the number of the folder currently being used. When the drive mode is set to [Bracketing], images are stored in the same folder until shooting is completed.

 **Caution**

- The maximum folder number is 999. After the folder number reaches 999, you cannot capture new images if you attempt to change the folder name or create a new folder, or when the file name number reaches 9999.



File Name

One of the following string of characters is used as the file name prefix depending on the [Color Space] setting of [Image Capture Settings] in the 2 menu.

Color Space	File Name
sRGB	IMG*****.JPG
AdobeRGB	_IMG*****.JPG

The first four characters can be changed to a character string of your choice.

1 Select [File Name] in 4 menu and press **▶**.
The [File Name] screen appears.

2 Select  or , and press **▶**.
The text-entry screen appears.



3 Change the text.

Up to four single-byte alphanumeric characters can be entered as an alternative for the first part of the file name, while the asterisks stand for figures that increase automatically shot by shot.

Refer to Steps 4 and 5 of "Folder Name" (p.115) for how to enter text.

4 Press **MENU** twice.

Memo

- When [Color Space] is set to [AdobeRGB], the file name prefix is “_” and first three characters of the entered character string becomes the file name.
- For movies, regardless of the [Color Space] setting, the file name is “IMG*****.MOV” or the one with the entered string of characters.

File No.

Each file name consists of a string of four characters and a sequential number from 0001 to 9999. You can set whether to continue the sequential numbering for the file name even if a new folder is created in [Sequential Numbering] of [File No.] in the **4** menu.

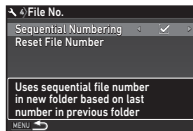

<input checked="" type="checkbox"/>	Continues the sequential numbering for the file name even if a new folder is created.
<input type="checkbox"/>	Returns the file number of the first image saved to a folder to 0001 each time a new folder is created.

Select [Reset File Number] to reset the file number to its default value.

Memo

- When the file number reaches 9999, a new folder is created and the file number is reset.

Setting the Copyright Information

4

Sets the photographer and copyright information embedded in the Exif data.

1 Select [Copyright Information] in **4** menu and press **▶**.

The [Copyright Information] screen appears.

2 Use **◀▶** to set [Embed Copyright Data].



<input type="checkbox"/>	Does not embed copyright information in the Exif data.
<input checked="" type="checkbox"/>	Embeds copyright information in the Exif data.

3 Select [Photographer] or [Copyright Holder], and press **▶**.

The text-entry screen appears.

4 Change the text.

Up to 32 single-byte alphanumeric characters and symbols can be entered.

Refer to Steps 3 and 4 of “Editing a Setting Name” (p.111) for how to enter text.

5 Press **MENU** twice.

Memo

- The Exif information can be checked in Detailed Information Display of the playback mode (p.17) or using the provided software “Digital Camera Utility 5”.

Restrictions on Each Capture Mode

#: Restricted X: Not available

Capture Mode Function	AUTO	SCN									B	
Sensitivity							X	X		X	*1	
Flash						X	X			X		X
Drive Mode	Continuous Shooting			H*2			X			H*2	X	X
	Self-timer			X					X			X
	Remote Control			X					X			*3
	Bracketing			X			X		X		X	X
	Multi-exposure			X			X		X			X
	Interval Shooting			X					X		X	X
	Interval Composite			X			X		X		X	X
	Interval Movie Record			X					X		X	X
Star Stream			X			X		X		X	X	
AF with Viewfinder	A.F.A.*2	A.F.S.*2	A.F.S.*2	A.F.C.*2	A.F.S.*2	A.F.S.*2	A.F.S.*2	A.F.C.*2	A.F.C.*2	A.F.C.*2		

Function	Capture Mode	SCN									B		
		AUTO											
File Format RAW/RAW+													x
White Balance	AWB ^{*2}	AWB ^{*2}	AWB ^{*2}	AWB ^{*2}	AWB ^{*2}	AWB ^{*2}	AWB ^{*2}	AWB ^{*2}	AWB ^{*2}	AWB ^{*2}	AWB ^{*2}		
Custom Image	x ^{*4}	x ^{*4}	x ^{*4}	x ^{*4}	x ^{*4}	x ^{*4}	x ^{*4}	x ^{*4}	x ^{*4}	x ^{*4}	x ^{*4}		
Clarity/Skin Tone							x						
Digital Filter							x						
HDR Capture				x			x ^{*5}		x			x	x
Pixel Shift Resolution				x			x		x			x	x
AA Filter Simulator				# ^{*6}			x		# ^{*6}			# ^{*6}	x
Shake Reduction							On ^{*2}					x	
Save RAW Data				x					x				x

*1 [ISO AUTO] is not available.

*2 Fixed to; the setting cannot be changed.

*3 Limited to; available settings are limited.

*4 Fixed to; specific settings to the selected mode are used.

*5 Fixed to [HDR AUTO].

*6 [Bracketing] is not available.

Restrictions on the Combinations of Special Functions

#: Restricted x: Not available

		Clarity/ Skin Tone/ Digital Filter	HDR Capture	Pixel Shift Resolution	ASTRO- TRACER	AA Filter Simulator	Distortion Correction/ Diffraction Correction	Save RAW Data
	Flash		x	x				
Drive Mode	Continuous Shooting		x	x	x	# ^{*2}		x
	Bracketing		x	x	x	# ^{*2}		
	Mirror Lock-up Shooting		x			# ^{*2}		
	Multi-exposure	x	x	x	x	# ^{*2}	x	
	Interval Shooting	# ^{*1}	# ^{*1}	x	x	# ^{*2}		# ^{*3}
	Interval Composite	x	x	x	x	# ^{*2}	x	# ^{*3}
	Interval Movie Record	# ^{*1}	# ^{*1}	x	x	# ^{*2}		x
	Star Stream	x	x	x	x	# ^{*2}	x	x
	HDR Capture	x		x	x			
	Pixel Shift Resolution	x	x		x	x		
	AA Filter Simulator		x	x	# ^{*2}			

*1 There is a restriction on the minimum value for [Interval].

*2 [Bracketing] is not available.

*3 Only the final frame can be saved.

Functions Available with Various Lenses

All capture modes are available when a DA, DA L, D FA, FA J, or FA lens is used, or when a lens with an **A** position is used with the aperture ring set to the **A** position.

Depending on the lens to use, the following restrictions apply.

✓: Available #: Restricted ✕: Not available

Function \ Lens [Mount type]	DA	FA J	F *6	A	M
	DA L D FA	FA *6 FA *6			P
	[KAF] [KAF2] [KAF3] [KAF4]	[KAF] [KAF2]	[KAF]	[KA]	[K]
Autofocus (Lens only) (With AF adapter 1.7x) ^{*1}	✓ –	✓ –	✓ –	– #	– #
Manual focus (With focus indicator) ^{*2} (With matte field)	✓	✓	✓	✓	✓
Quick-shift focus	# ^{*4}	✕	✕	✕	✕
AF Active Area [Auto]	✓	✓	✓	# ^{*8}	✕
AE Metering [Multi-segment]	✓	✓	✓	✓	✕
P/Sv/Tv/Av/TA v mode	✓	✓	✓	✓	# ^{*9}
M mode	✓	✓	✓	✓	#
P-TTL auto flash ^{*3}	✓	✓	✓	✓	✕
Automatic obtaining of the lens focal length information	✓	✓	✓	✕	✕
Lens Correction	✓ ^{*5}	# ^{*7}	✕	✕	✕

- *1 Lenses with a maximum aperture of F2.8 or faster. Only available at the **A** position.
- *2 Lenses with a maximum aperture of F5.6 or faster.
- *3 Available when using the built-in flash, AF540FGZ, AF540FGZ II, AF360FGZ, AF360FGZ II, AF201FG, AF200FG, or AF160FC.
- *4 Only available with compatible lenses.
- *5 Distortion Correction and Peripheral Illumination Correction are disabled when a DA FISH-EYE 10-17mm lens is used.
- *6 To use an FA SOFT 28mm F2.8 lens, FA SOFT 85mm F2.8 lens, or F SOFT 85mm F2.8 lens, set [24 Using Aperture Ring] to [Enable] in the **C4** menu. Pictures can be taken with the aperture you set, but only within a manually adjustable aperture range.
- *7 The Lens Correction features are available with the following FA lenses (Only Distortion Correction and Lateral Chromatic Aberration Adjustment can be used when the aperture ring is set to a position other than **A**.): FA *24mm F2 AL [IF], FA 28mm F2.8 AL, FA 31mm F1.8 Limited, FA 35mm F2 AL, FA 43mm F1.9 Limited, FA 50mm F1.4, FA 77mm F1.8 Limited, FA *85mm F1.4 [IF], FA *200mm F2.8 ED [IF], FA *MACRO 200mm F4 ED, FA *300mm F2.8 ED [IF], FA *300mm F4.5 ED [IF], FA *400mm F5.6 ED [IF], FA *600mm F4 ED [IF], FA *28-70mm F2.8 ED [IF], FA *80-200mm F2.8 ED [IF], and FA *250-600mm F5.6 ED [IF].
- *8 Fixed to [Spot].
- *9 **Av** with the aperture set to wide open. (The aperture ring has no effect on the actual aperture value.)

⚠ Caution

- When the aperture ring is set to a position other than **A** or a lens without an **A** position or accessories such as an extension tube are used, the camera does not operate unless [24 Using Aperture Ring] is set to [Enable] in the **C4** menu. Refer to "Using the Aperture Ring" (p.123) for details.
- When a retractable lens is attached and is not extended, you cannot take pictures or use some functions. If the lens is retracted during shooting, the camera stops working.

About Mount Names

DA and D FA lenses with a motor and FA zoom lenses with a power zoom use the KAF2 mount. (Of these lenses, the lenses without an AF coupler use the KAF3 mount.)

The KAF3 mount equipped with an electromagnetic diaphragm mechanism instead of an aperture control lever is referred to as the KAF4 mount.

FA single focal length lenses (non-zoom lenses), DA and DA L lenses without a motor, and D FA, FA J, and F lenses use the KAF mount. (The power zoom function is not compatible with this camera.)

Refer to respective lens manuals for details.

Compatibility with the Built-in Flash

Depending on the lens being used, the use of the built-in flash may be limited.

(As of April 2016)

Lens	Restrictions when using the built-in flash
DA FISH-EYE 10-17mm F3.5-4.5 ED [IF]/ DA 12-24mm F4 ED AL/ DA 14mm F2.8 ED [IF]/ DA 15mm F4 ED AL/ D FA 15-30mm F2.8 ED SDM WR/ FA★300mm F2.8 ED [IF]/ DA★560mm F5.6 ED AW/ FA★600mm F4 ED [IF]/ FA★250-600mm F5.6 ED [IF]	The built-in flash is not available due to vignetting.
F FISH-EYE 17-28mm F3.5-4.5	Vignetting may occur if the focal length is less than 20 mm.
DA 16-45mm F4 ED AL	When the focal length is less than 28 mm, or when the focal length is 28 mm and the shooting distance is 1 m or less, vignetting may occur.
DA★16-50mm F2.8 ED AL [IF] SDM	When the focal length is 20 mm or less, or when the focal length is 35 mm and the shooting distance is less than 1.5 m, vignetting may occur.

Lens	Restrictions when using the built-in flash
DA 16-85mm F3.5-5.6 ED DC WR	When the focal length is 24 mm or less and the shooting distance is 0.8 m or less, vignetting may occur.
DA 17-70mm F4 AL [IF] SDM	When the focal length is less than 24 mm, or when the focal length is 35 mm and the shooting distance is 1 m or less, vignetting may occur.
DA 18-250mm F3.5-6.3 ED AL [IF]	Vignetting may occur if the focal length is less than 35 mm.
DA 18-270mm F3.5-6.3 ED SDM	Vignetting may occur if the focal length is less than 24 mm.
D FA 24-70mm F2.8 ED SDM WR	Vignetting may occur if the focal length is less than 36 mm.
FA★28-70mm F2.8 AL	Vignetting may occur if the focal length is 28 mm and the shooting distance is less than 1 m.
FA SOFT 28mm F2.8/ FA SOFT 85mm F2.8	The built-in flash always discharges fully.

Using the Aperture Ring

C4

The shutter can be released even if the aperture ring of the D FA, FA, F, or A lens is not set to the **A** position or a lens without an **A** position is attached.

Select [Enable] in [24 Using Aperture Ring] of the **C4** menu.

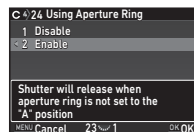

The following restrictions apply depending on the lens being used.

Lens	Restriction
D FA, FA, F, A, M (lens only or with automatic diaphragm accessories such as auto extension tube K)	The aperture remains open*1. The shutter speed changes in relation to the open aperture but an exposure deviation may occur.
D FA, FA, F, A, M, S (with diaphragm accessories such as extension tube K)	Pictures can be taken with the set aperture value but an exposure deviation may occur.
Manual diaphragm lens such as reflex lens (lens only)	
FA SOFT 28mm/ FA SOFT 85mm/ F SOFT 85mm (lens only)	Pictures can be taken with the set aperture value within a manually adjustable aperture range*1.

*1 When the mode dial is set to **M** or **B**, the aperture can be stopped down to the selected value.

Memo

- If the aperture ring is set to a position other than **A**, the camera operates in **Av** mode regardless of the mode dial setting except when set to **M** or **B** mode.
- [F--] appears for the aperture indicator in the status screen, Live View screen, and viewfinder.

How to Achieve the Correct Exposure with the Aperture Ring Not Set to **A**

The correct exposure can be achieved by the following procedures when the aperture ring is not set to **A**.

- 1 Set the mode dial to **M**.
- 2 Set the aperture ring to the desired aperture.
- 3 Press **O**.
The correct shutter speed will be set.
- 4 If the correct exposure cannot be achieved, adjust the ISO sensitivity.

Performing Catch-in Focus Shooting

C4

You can perform Catch-in Focus shooting using a manual focus lens. The shutter is released automatically when the subject comes into focus.

- 1 **Attach a manual focus lens to this camera.**
- 2 **Set [22 Catch-in Focus] to [On] in the C4 menu.**
- 3 **Set the focus method to **AF** and set [AF Mode] to **A.F.S.****
- 4 **Place the camera on a fixed support such as tripods.**
- 5 **Adjust the focus to the position where the subject may pass and press **SHUTTER** fully.**
When the subject comes into focus at the specified position, the shutter is released automatically.

Setting the Focal Length



The Shake Reduction function operates by obtaining the lens information such as focal length. Set the focal length when using a lens that the focal length information cannot be automatically obtained.

- 1 Set [24 Using Aperture Ring] to [Enable] in the C4 menu.
- 2 Turn the camera off.
- 3 Attach a lens to the camera and turn the camera on.

The [Input Focal Length] screen appears.

- 4 Use ▲▼ to set the focal length.

Press ◀ to select a value from the list.

When using a zoom lens, select the actual focal length which the zoom is set to.

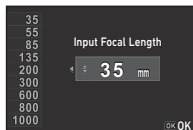

- 5 Press **OK**.

The camera returns to standby mode.

Memo

- The focal length setting can be changed in [Input Focal Length] of the 4 menu.

Functions when Using an External Flash

Use of the following external flashes (optional) enables a variety of flash modes, such as P-TTL auto flash mode.

✓ : Available # : Restricted ✕ : Not available

Camera Function \ Compatible Flash	Built-in Flash	AF540FGZ AF540FGZ II AF360FGZ AF360FGZ II	AF201FG AF200FG AF160FC
Red-eye reduction flash	✓	✓	✓
Auto Flash Discharge	✓	✓	✓
Automatic switch to the flash sync speed	✓	✓	✓
Automatic setting of the aperture value in P or Tv mode	✓	✓	✓
P-TTL auto flash	✓ ^{*1}	✓ ^{*1}	✓ ^{*1}
Slow-speed Sync flash	✓	✓	✓
Flash Exposure Compensation	✓	✓	✓
AF assist light of the external flash	✕	✓ ^{*2}	✕
Trailing Curtain Sync flash ^{*3}	✓	✓	# ^{*4}
Contrast Control Sync flash	# ^{*5}	✓	# ^{*6}
Slave flash	✕	✓	✕
High-speed Sync flash	✕	✓	✕

- *1 Available only when using a DA, DA L, D FA, FA J, FA, F, or A lens. (When using a lens with an aperture ring, set the aperture ring to the **A** position.)
- *2 AF assist light is not available with the AF540FGZ or AF360FGZ.
- *3 Shutter speed of 1/90 seconds or slower.
- *4 Available with the AF201FG.
- *5 When combined with the AF540FGZ, AF540FGZ II, AF360FGZ, or AF360FGZ II, 1/3 of the flash discharge can be output by the built-in flash and 2/3 can be output by the external flash.
- *6 Available only when combined with the AF540FGZ, AF540FGZ II, AF360FGZ, or AF360FGZ II.

⚠ Caution

- Never press **⏻** on the camera when any external flash unit is attached to the camera. The built-in flash will hit the external flash. If you want to use both at once, connect them using an extension cord.
- Flashes with the reversed polarity (the center contact on the hot shoe is minus) cannot be used due to the risk of damaging the camera and flash.
- Do not combine with accessories that have a different number of contacts, such as Hot Shoe Grip, as a malfunction may occur.
- Combining with flashes from other manufacturers may cause equipment breakdown.

📄 Memo

- With the AF540FGZ, AF540FGZ II, AF360FGZ, or AF360FGZ II, you can use the high-speed sync flash to discharge a flash and take a picture at a shutter speed faster than 1/180 seconds. Set the capture mode to **Tv**, **TAv**, or **M**.

Using the GPS Unit

In addition to GPS information being saved in the shooting information of the image, the following functions are available when the optional GPS unit O-GPS1 is attached to this camera.

Electronic Compass	Displays the current latitude, longitude, altitude, direction, Coordinated Universal Time (UTC), capture mode, and exposure value. 
ASTROTRACER	Tracks and captures celestial bodies. By matching the movement of the camera's built-in Shake Reduction unit with the movement of celestial bodies, celestial bodies can be captured as individual points even when shooting with a long exposure setting. (p.127)
GPS Time Sync	Automatically adjusts the camera's date and time settings using information obtained from GPS satellites. Set in [GPS/E-Compass] of the 3 menu.

📄 Memo

- Refer to the manual of the GPS unit for details on how to attach the unit and information on the unit's functions.
- To display [Electronic Compass], refer to "Shooting Info Display" (p.15).

⚠ Caution



- "Simple Navigation" cannot be used with this camera.

Shooting Celestial Bodies (ASTROTRACER)

Setting the ASTROTRACER





1 Attach the GPS unit to the camera and turn the camera on.

2 Select [ASTROTRACER] in  menu and press .
The [ASTROTRACER] screen appears.

3 Select [ASTROTRACER] and press .

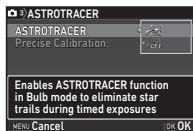
4 Select [On] and press **OK**.



5 Select [Precise Calibration] and press .
The [Precise Calibration] screen appears.

6 Rotate the camera according to the instruction displayed on the monitor.
The result of calibration appears.

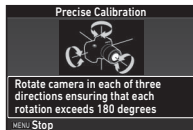

7 Press **OK**.

The screen of Step 4 reappears.

If [The operation could not be completed correctly] appears, change the camera direction and perform a calibration again.

8 Press **MENU** twice.

The camera returns to standby mode.

Caution



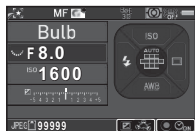

- When performing a calibration, be careful not to drop the camera. Wrap the strap around your wrist or take other preventive measures.
- If the battery is removed, perform a calibration again after the battery is put back in.
- As the magnetic field environment varies depending on the shooting location, a precise calibration must be performed at each location when shooting images of celestial bodies with ASTROTRACER.
- Changing the lens or the angle of the monitor after performing a calibration may have some effect on the magnetic field environment. In this case, perform a calibration again.

Shooting with the ASTROTRACER

- 1 Set the mode dial to **B** and set the focus method to **MF**.
- 2 Set the shooting conditions.



Available operations

- | | |
|---|--|
|  | Enables/Disables the timed exposure. |
|  | Changes the exposure time within the range from 10" to 5'00" when the timed exposure is enabled. |
|  | Changes the aperture value. |
|  | Performs a precise calibration. |

- 3 Adjust the focus and press **SHUTTER** fully.

Shooting starts.

- 4 Press **SHUTTER** fully again.

Shooting stops.

When the timed exposure is enabled, shooting stops automatically after the set time has elapsed.

⚠ Caution

- This function cannot be used in some capture modes or in combination with some other functions. (p.118)

When the Monitor is too Bright











For shooting in a dark place for a long period of time, you can change the monitor display color to red by setting [Night Vision LCD Display] to [On] in the **Fn2** menu. When [Night Vision LCD Display] is assigned to **Fx1** or **Fx2** in [Button Customization] of the **Fn5** menu, you can turn the Night Vision LCD Display on or off by a simple button operation. (p.106)

Troubleshooting

🌀 Memo

- In rare cases, the camera may not operate correctly due to causes such as static electricity, etc. This can be remedied by taking the battery out and putting it back in again. If the camera operates correctly, it does not require any repairs.

Problem	Cause	Remedy
The camera does not turn on.	The battery is not installed properly.	Check the orientation of the battery.
	The battery power is low.	Charge the battery.
The shutter cannot be released.	The built-in flash is being charged.	Wait until charging is finished.
	There is no available space on the memory card.	Insert a memory card with available space or delete unwanted images.
	Data is being processed.	Wait until processing is finished.
	The lens aperture ring is set to a position other than A .	Set the lens aperture ring to the A position or select [Enable] in [24 Using Aperture Ring] of the C4 menu. (p.123)
	The autofocus mode is set to AFS and the subject is not in focus.	Set the focus method to MF and adjust focus manually.



Problem	Cause	Remedy
Autofocus does not work.	The subject is difficult to focus on.	AF cannot work well for low-contrast objects (the sky, white walls, etc.), dark colors, intricate designs, rapidly-moving objects, or scenery shot through a window or a net-like pattern. Lock the focus on another object located at the same distance as your subject, then aim at the target and take a picture. Alternatively, use MF .
	The subject is too close.	Move away from the subject and take a picture.
The focus cannot be locked.	 is set for [AF Active Area] of Live View.	Set [AF Active Area] to  ,  ,  , or  . (p.63)
The built-in flash does not discharge.	The flash mode is set to  or  .	When the flash mode is set to  or  , the flash does not discharge if the subject is bright. Change the flash mode. (p.59)
The camera is not recognized when it is connected to a computer.	The USB connection mode is set to [PTP].	Set [USB Connection] to [MSC] in the  3 menu.
Dust or dirt particles appear in images.	The CMOS sensor is dirty or dusty.	Activate [Dust Removal] from the  5 menu. The Dust Removal function can be activated every time the camera is turned on and off. Refer to "Sensor Cleaning" (p.130) if the problem persists.

Problem	Cause	Remedy
Pixel defects such as bright spots and dark spots appear in the image.	There are defective pixels in the CMOS sensor.	Activate [Pixel Mapping] from the  5 menu. It takes about 30 seconds to correct the defective pixels, so be sure to install a fully charged battery.

Sensor Cleaning



Raise the mirror up and open the shutter when cleaning the CMOS sensor with a blower.

- 1 Turn the camera off and remove the lens.**
- 2 Turn the camera on.**
- 3 Select [Sensor Cleaning] in 5 menu and press .**
The [Sensor Cleaning] screen appears.
- 4 Select [Mirror Up] and press .**
The mirror rises up.
- 5 Clean the CMOS sensor with a blower.**
- 6 Turn the camera off.**
The mirror automatically returns to its original position.

⚠ Caution

- Never use a spray blower or a blower with a brush. The CMOS sensor may be damaged. Do not wipe the CMOS sensor with a cloth.
- Do not put the tip of the blower inside the lens mount area. If the power is turned off during cleaning, it may cause damage to the shutter, the CMOS sensor, and the mirror. Hold the camera with the lens mount down while cleaning the sensor so dust will fall away from the sensor when the blower is used.
- When the battery level is low, the message [Not enough battery power remaining to clean sensor] is displayed on the monitor. Install a fully charged battery. If the battery capacity becomes low during cleaning, a warning beep will sound. In this case, stop cleaning immediately.

📝 Memo

- Please contact your nearest service center for professional cleaning as the CMOS sensor is a precision part.
- You can use the optional Image Sensor Cleaning Kit O-ICK1 when cleaning the CMOS sensor.

Error Messages

Error Messages	Description
Memory card full	The memory card is full and no more images can be saved. Insert a new memory card or delete unwanted files.
No image	There are no images that can be played back on the memory card.
This image cannot be displayed	You are trying to play back an image in a format not supported by this camera. You may be able to play it back on a computer.
No card in the camera	There is no memory card inserted in the camera.
Memory card error	The memory card has a problem, and image capture and playback are impossible. You may be able to play back or recover the images on a computer.
Card is not formatted	The memory card you have inserted is unformatted or has been previously used on another device and is not compatible with this camera. Use the card after formatting it with this camera.
Card is locked	The write-protect switch on the memory card you have inserted is locked. (p.146)
Cannot use this card	A memory card not compatible with this camera is inserted.
Wi-Fi connection disabled	The capture mode is changed to  mode while the wireless LAN function is enabled.
This image cannot be magnified	You are trying to magnify an image that cannot be magnified.
This image is protected	You are trying to delete an image that is protected. Remove the protection from the image. (p.114)

Error Messages	Description
Not enough battery power remaining to activate Pixel Mapping	These messages appear when you try to perform Pixel Mapping or Sensor Cleaning, or to update the firmware if the battery level is insufficient. Install a fully charged battery.
Not enough battery power remaining to clean sensor	
Not enough battery power remaining to update the firmware	
Unable to update firmware. There is a problem with the firmware update file	The firmware cannot be updated. The update file is damaged. Try downloading the update file again.
Image folder cannot be created	The maximum folder number (999) is being used, and no more images can be saved. Insert a new memory card or format the card.
Unable to store image	The image could not be saved because of a memory card error.
The operation could not be completed correctly	The operation failed. Try the operation again.
No more images can be selected	You are trying to select more than the maximum number of images for the following functions. <ul style="list-style-type: none"> • Select & Delete • RAW Development • Protect
No image can be processed	There are no images that can be processed using the Digital Filter or RAW Development function.
This image cannot be processed	This message appears when you try to perform Resize, Cropping, Digital Filter, Movie Edit, RAW Development, or Save as Manual WB for images captured with other cameras, or when you try to perform Resize or Cropping for minimum file size images.

Error Messages	Description
This function is not available in the current mode	You are trying to set a function that is not available with the currently selected capture mode.
The camera will turn off to prevent damage from overheating	The camera will turn off because its internal temperature is too high. Leave the camera turned off until it has had time to cool down before turning on the camera again.
Shutter release is disabled. Ensure the zooming index on the lens is set to a position that permits shutter release	Pictures cannot be taken when a retractable lens is attached and is not extended. (p.46)

Main Specifications

Model Description

Type	TTL autofocus, auto-exposure SLR digital camera with a built-in retractable P-TTL flash
Lens Mount	PENTAX KAF2 bayonet mount (AF coupler, lens information contacts, K-mount with power contacts)
Usable Lenses	KAF4, KAF3, KAF2 (power zoom not compatible), KAF, KA mount lenses

Image Capture Unit

Image Sensor	CMOS with a primary color filter, Size: 23.5 × 15.6 (mm)
Effective Pixels	Approx. 24.24 megapixels
Total Pixels	Approx. 24.78 megapixels
Dust Removal	Image sensor movement combined with SP coating
Sensitivity (Standard Output)	ISO AUTO, Manual ISO range: 100 to 102400 • EV steps can be set to 1 EV, 1/2 EV, or 1/3 EV
Image Stabilizer	Sensor-shift Shake Reduction (SR)
AA Filter Simulator	Moiré reduction using SR unit: Off, Type1, Type2, Bracketing (3 images)

File Formats

Recording Formats	RAW (PEF/DNG), JPEG (Exif 2.3 compliant), DCF 2.0 compliant
Recorded Pixels	JPEG: [L] (24M: 6000×4000), [M] (14M: 4608×3072), [S] (6M: 3072×2048), [XS] (2M: 1920×1280) RAW: [L] (24M: 6000×4000)
Quality Level	RAW (14bit): PEF, DNG JPEG: ★★★ (Best), ★★ (Better), ★ (Good) • RAW + JPEG simultaneously recordable
Color Space	sRGB, AdobeRGB
Storage Media	SD/SDHC*/SDXC* memory card * UHS-I compatible

Storage Folder	Folder Name: Date (100_1018, 101_1019...) or user-assigned name (default: PENTX)
Storage File	File Name: user-assigned name (default: IMGPF****) File No.: Sequential Numbering, Reset

Viewfinder

Type	Pentaprism Finder
Coverage (FOV)	Approx. 100%
Magnification	Approx. 0.95× (50mm F1.4 at infinity)
Eye-Relief Length	Approx. 20.5 mm (from the view window) Approx. 22.3 mm (from the center of lens)
Diopter Adjustment	Approx. -2.5 to +1.5 m ⁻¹
Focusing Screen	Interchangeable Natural-Bright-Matte III focusing screen

Live View

Type	TTL method using the CMOS image sensor
Autofocusing System	Hybrid AF of image plane phase-matching and contrast detection AF Active Area: Face Detection, Tracking, Multiple AF Points, Select, Spot Focus Peaking: On, Off
Display	Field of view: approx. 100%, Magnified view (up to 16×), Grid Display (4×4 Grid, Golden Section, Scale, Square 1, Square 2, Grid Color: Black, White), Histogram, Highlight Alert

LCD Monitor

Type	Vari-angle TFT color LCD monitor featuring an air-gapless structure with a tempered-glass front panel
Size	3.0 inches (aspect ratio 3:2)
Dots	Approx. 921K dots
Adjustment	Brightness, saturation and colors adjustable

Outdoor View Setting	±2 steps
Night Vision LCD Display	On, Off

White Balance

Type	TTL method using the CMOS image sensor
Preset Modes	Auto White Balance, Multi Auto White Balance, Daylight, Shade, Cloudy, Fluorescent Light (D: Daylight Color, N: Daylight White, W: Cool White, L: Warm White), Tungsten Light, CTE , Manual White Balance (up to 3 settings), Color Temperature (up to 3 settings), Copying the white balance settings of a captured image
Fine Adjustment	Adjustable ±7 steps on A-B axis and G-M axis

Focus System

Type	TTL phase-matching autofocus system
Focus Sensor	SAFOX X, 11 points (9 cross type focus points in the center)
Brightness Range	EV -3 to 18 (ISO100, at normal temperature)
AF Modes	Single AF (A.F.S.), Continuous AF (A.F.C.), Auto select AF (A.F.A.)
Focusing Area Selection Modes	Auto (11 AF Points), Auto (5 AF Points), Select, Expanded Area AF, Spot
AF Assist Light	Dedicated LED AF assist light

Exposure Control

Type	TTL open-aperture 77 segment metering Metering modes: Multi-segment, Center-weighted, Spot
Metering Range	EV 0 to 22 (ISO100 at 50mm F1.4)

Capture Modes	Auto Picture (AUTO) modes: Standard, Portrait, Landscape, Macro, Moving Object, Night Scene Portrait, Sunset, Blue Sky, Forest Scene (SCN) modes: Portrait, Landscape, Macro, Moving Object, Night Scene Portrait, Sunset, Blue Sky, Forest, Night Scene, Night Scene HDR, Night Snap, Food, Pet, Kids, Surf & Snow, Backlight Silhouette, Candlelight, Stage Lighting, Museum Exposure modes: Program, Sensitivity Priority, Shutter Priority, Aperture Priority, Shutter & Aperture Priority, Manual, Bulb
EV Compensation	±5 EV (1/3 EV steps or 1/2 EV steps can be selected)
AE Lock	Can be assigned to AF/AE-L in [Button Customization].

Shutter

Type	Electronically controlled vertical-run focal plane shutter • Electronic shutter is used for Pixel Shift Resolution
Shutter Speed	Auto: 1/6000 to 30 seconds, Manual: 1/6000 to 30 seconds (1/3 EV steps or 1/2 EV steps), Bulb (timed exposure setting possible from 10 seconds to 20 minutes)

Drive Modes

Mode Selection	[Still picture] Single frame, Continuous (H, L), Self-timer (12 sec., 2 sec., continuous), Remote Control (immediately, 3 sec., continuous), Bracketing ^{*1} (2, 3, or 5 frames), Mirror Lock-up Shooting ^{*2} , Multi-exposure ^{*3} , Interval Shooting ^{*1} , Interval Composite ^{*1} , Interval Movie Record ^{*1} , Star Stream ^{*1} [Movie] Remote Control ^{*1} Available with Self-timer or Remote Control ^{*2} Available with Remote Control ^{*3} Available with Continuous Shooting, Self-timer, or Remote Control
----------------	---

Continuous Shooting	Max. approx. 6.0 fps, JPEG (L): ★★★ at Continuous H: up to approx. 40 frames, RAW: up to approx. 10 frames, RAW+: up to approx. 8 frames Max. approx. 3.0 fps, JPEG (L): ★★★ at Continuous L: up to approx. 100 frames, RAW: up to approx. 16 frames, RAW+: up to approx. 11 frames • When the sensitivity is set to ISO100
Multi-exposure	Composite Mode: Additive, Average, Bright Number of Shots: 2 to 2000 times
Interval Shooting	[Interval Shooting] Interval: 2 sec. to 24 hr., Standby Interval: minimum time or 1 sec. to 24 hr., Number of Shots: 2 to 2000 times, Start Interval: Now, Self-timer, Remote Control, Set Time [Interval Composite] Interval: 2 sec. to 24 hr., Standby Interval: minimum time or 1 sec. to 24 hr., Number of Shots: 2 to 2000 times, Start Interval: Now, Self-timer, Remote Control, Set Time, Composite Mode: Additive, Average, Bright, Save Process: On, Off [Interval Movie Record] Recorded Pixels: [4K], [FHD], [HD], Recording Format: Motion JPEG (AVI), Interval: 2 sec. to 24 hr., Standby Interval: minimum time or 1 sec. to 24 hr., Number of Shots: 8 to 2000 times (When [4K] is selected: 8 to 500 times), Start Interval: Now, Self-timer, Remote Control, Set Time [Star Stream] Recorded Pixels: [4K], [FHD], [HD], Recording Format: Motion JPEG (AVI), Standby Interval: minimum time or 1 sec. to 24 hr., Number of Shots: 8 to 2000 times (When [4K] is selected: 8 to 500 times), Start Interval: Now, Self-timer, Remote Control, Set Time, Fade-out: Off, Low, Medium, High

Flash



Built-in Flash	Built-in retractable P-TTL pop-up flash Guide number: approx. 12 (ISO100/m) Angle of view coverage: equivalent to 28mm lens in 35 mm format
----------------	---

Flash Modes	Auto Flash Discharge (Auto Picture, Scene Mode), Auto Flash + Red-eye Reduction (Auto Picture, Scene Mode), Flash On, Flash On + Red-eye Reduction, Slow-speed Sync, Slow-speed Sync + Red-eye Reduction, Trailing Curtain Sync, Manual Flash Discharge (FULL to 1/128 power)
Sync Speed	1/180 seconds
Flash Exposure Compensation	-2.0 to +1.0 EV
External Flash	P-TTL, Leading Curtain Sync, Trailing Curtain Sync, Contrast Control Sync*, High-speed Sync, Wireless Sync* * Available with two or more dedicated external flash units

Capture Functions

Custom Image	Auto Select, Bright, Natural, Portrait, Landscape, Vibrant, Radiant, Muted, Flat, Bleach Bypass, Reversal Film, Monochrome, Cross Processing
Cross Processing	Random, Preset 1-3, Favorite 1-3
Digital Filter	Extract Color, Replace Color, Toy Camera, Retro, High Contrast, Shading, Invert Color, Unicolor Bold, Bold Monochrome
Clarity	-4.0 to +4.0
Skin Tone	Type1, Type2, Off
HDR Capture	Auto, Type1, Type2, Type3, Advanced HDR, Off Bracket Value: adjustable Auto Align (automatic composition correction function): available
Pixel Shift Resolution	Motion Correction On, Motion Correction Off, Off
Lens Correction	Distortion Correction, Peripheral Illumination Correction, Lateral Chromatic Aberration Adjustment, Diffraction Correction
D-Range Settings	Highlight Correction, Shadow Correction
Noise Reduction	Slow Shutter Speed NR, High-ISO NR
Horizon Correction	SR On: corrects up to 1 degree SR Off: corrects up to 1.5 degrees
Electronic Level	Displayed in viewfinder (horizontal direction only); displayed on monitor (horizontal direction and vertical direction)

Movie



Recording Format	MPEG-4 AVC/H.264 (MOV)
Recorded Pixels	 (1920×1080, 60i/50i/30p/25p/24p)  (1280×720, 60p/50p)
Autofocusing System	Hybrid AF of image plane phase-matching and contrast detection AF Mode: Single AF (A.F.S.), Continuous AF (A.F.C.) * Continuous AF (A.F.C.) is available only when a compatible lens is attached to the camera. AF Active Area: Multiple AF Points, Select, Spot Focus Peaking: On, Off
Sound	Built-in stereo microphone, external microphone (stereo recording compatible) Recording Sound Level: adjustable
Recording Time	Up to 4 GB or 25 minutes; automatically stops recording if the internal temperature of the camera becomes high.
Custom Image	Auto Select, Bright, Natural, Portrait, Landscape, Vibrant, Radiant, Muted, Flat, Bleach Bypass, Reversal Film, Monochrome, Cross Processing
Cross Processing	Random, Preset 1-3, Favorite 1-3
Digital Filter	Extract Color, Replace Color, Toy Camera, Retro, High Contrast, Shading, Invert Color, Unicolor Bold, Bold Monochrome

Playback Functions

Playback View	Single image, Multi-image display (6, 12, 20, 35, and 80 thumbnails), Image magnification (Up to 16× and quick zoom), Grid Display (4×4 Grid, Golden Section, Scale, Square 1, Square 2, Grid Color: Black, White), Rotated image display, Histogram (Y histogram, RGB histogram), Highlight Alert, Auto Image Rotation, Detailed Information Display, Copyright Information (Photographer, Copyright Holder), GPS information (Latitude, Longitude, Altitude, Coordinated Universal Time (UTC)), Direction, Folder Display, Calendar Filmstrip Display, Slideshow
---------------	--

Delete	Single image, all images, select & delete, folder, Instant Review image
Digital Filter	Base Parameter Adj, Extract Color, Replace Color, Toy Camera, Retro, High Contrast, Shading, Invert Color, Unicolor Bold, Bold Monochrome, Tone Expansion, Sketch, Water Color, Pastel, Posterization, Miniature, Soft, Starburst, Fish-eye, Slim, Monochrome
RAW Development	Development options: Select single image, Select multiple images, Select a folder Development parameters: White Balance, Custom Image, Sensitivity, Clarity, Skin Tone, Digital Filter, HDR Capture, Pixel Shift Resolution, Shadow Correction, High-ISO NR, Distortion Correction, Peripheral Illumination Correction, Lateral Chromatic Aberration Adjustment, Diffraction Correction, Color Fringe Correction, Aspect Ratio, JPEG Recorded Pixels, JPEG Quality, Color Space
Editing Features	Image Rotation, Color Moiré Correction, Resize, Cropping (aspect ratio can be changed and tilt correction is available), Movie Edit (dividing a movie file and deleting unwanted segments), Capturing a JPEG still picture from a movie, Save RAW Data

Customization

USER Modes	Up to 3 settings can be saved.
Custom Functions	24 items
Mode Memory	16 items
Button Customization	 button: One Push File Format, Wi-Fi, Outdoor View Setting, Night Vision LCD Display, Preview, Electronic Level, Change AF Area  button: Enable AF1, Enable AF2, Cancel AF, AE Lock E-dials (front/rear): customizable to each exposure mode

AF Customization	AF.S: Focus-priority, Release-priority 1st Frame Action in AF.C: Auto, Focus-priority, Release-priority Action in AF.C Continuous: Auto, Focus-priority, FPS-priority Hold AF Status: Off, Low, Medium, High AF in Interval Shooting: Locks focus at 1st exposure, Adjusts focus for each shot AF with Remote Control: Off, On
Text Size	Standard, Large
World Time	World Time settings for 75 cities (28 time zones)
AF Fine Adjustment	±10 steps, adjustment for all lenses or individual lenses (up to 20 values can be saved)
Indicator Lamps	Other Indicator Lamps: High, Low, Off Self-timer: On, Off Remote Control: On, Off GPS LED Indicators: On, Off
Copyright Information	Names of "Photographer" and "Copyright Holder" are embedded to the image file. A revision history can be checked using the provided software.

Power Supply

Battery Type	Rechargeable Lithium-ion Battery D-LI109
AC Adapter	AC Adapter Kit K-AC168 (optional)
Battery Life	Number of recordable images: (with 50% flash usage): approx. 410 images (without flash usage): approx. 480 images Playback time: approx. 270 minutes • Tested in compliance with CIPA standard using a fully charged lithium-ion battery at a temperature of 23°C. Actual results may vary depending on the shooting conditions/circumstances.

Interfaces

Connection Port	USB 2.0 (micro B), HDMI output terminal (Type D), stereo microphone/cable release input terminal (ø3.5 mm connector)
USB Connection	MSC/PTP

Wireless LAN

Standards	IEEE 802.11b/g/n (standard wireless LAN protocol)
Frequency (Center Frequency)	2412 to 2462 MHz (channels: Ch 1 to Ch 11)
Security	Authentication: WPA2 Encryption: AES

Dimensions and Weight

Dimensions	Approx. 125.5 mm (W) × 93.0 mm (H) × 74.0 mm (D) (excluding protrusions)
Weight	Approx. 688 g (including dedicated battery and an SD Memory Card) Approx. 628 g (body only)

Operating Environment

Temperature	-10 to 40°C (14 to 104°F)
Humidity	85% or less (no condensation)

Included Accessories

Package Contents	Strap O-ST132, Rechargeable Lithium-ion Battery D-LI109, Battery Charger D-BC109, AC plug cord, Software (CD-ROM) S-SW168, Start Guide <Mounted to the camera> Eyecup FR, Hot shoe cover FR, Body mount cover
Software	Digital Camera Utility 5

Optional Accessories

GPS Unit	O-GPS1: GPS information (Latitude, Longitude, Altitude, Coordinated Universal Time (UTC)), Direction, Electronic Compass, ASTROTRACER
Cable Release	Cable Switch CS-310

Approximate Image Storage Capacity and Playback Time

(When using the fully charged battery)

Battery	Temperature	Normal Shooting	Flash Photography		Playback Time
			50% Use	100% Use	
D-LI109	23°C	480	410	360	270 minutes

- Tested in compliance with CIPA standard using a fully charged lithium-ion battery at a temperature of 23°C. Actual results may vary depending on the shooting conditions/circumstances.

Approximate Image Storage Capacity by Size

(When using an 8 GB memory card)

Recorded Pixels	JPEG Quality			PEF
	★★★	★★	★	
L 24M	528	1192	2339	151
M 14M	889	1996	3837	–
S 6M	1964	4309	7923	–
XS 2M	4723	9824	16374	–

- The number of storable images may vary depending on the subject, shooting conditions, selected capture mode, and memory card, etc.

List of World Time Cities

The following cities can be set as Hometown and Destination.

Region	City
North America	Honolulu, Anchorage, Vancouver, San Francisco, Los Angeles, Calgary, Denver, Chicago, Miami, Toronto, New York, Halifax
Central and South America	Mexico City, Lima, Santiago, Caracas, Buenos Aires, Sao Paulo, Rio de Janeiro
Europe	Lisbon, Madrid, London, Paris, Amsterdam, Milan, Rome, Copenhagen, Berlin, Prague, Stockholm, Budapest, Warsaw, Athens, Helsinki, Moscow
Africa/ West Asia	Dakar, Algiers, Johannesburg, Istanbul, Cairo, Jerusalem, Nairobi, Jeddah, Tehran, Dubai, Karachi, Kabul, Male, Delhi, Colombo, Kathmandu, Dacca
East Asia	Yangon, Bangkok, Kuala Lumpur, Vientiane, Singapore, Phnom Penh, Ho chi Minh, Jakarta, Hong Kong, Beijing, Shanghai, Manila, Taipei, Seoul, Tokyo, Guam
Oceania	Perth, Adelaide, Sydney, Noumea, Wellington, Auckland, Pago Pago

Operating Environment for USB Connection and Provided Software

With the provided software "Digital Camera Utility 5", you can develop RAW images, make color adjustments, or check shooting information on a computer. Install the software from the provided CD-ROM (S-SW168).

We recommend the following system requirements to connect the camera to a computer with a commercially available USB cable and to use the software.

Windows

OS	Windows 10 (32-bit, 64-bit), Windows 8.1 (32-bit, 64-bit), Windows 8 (32-bit, 64-bit), or Windows 7 (32-bit, 64-bit)
CPU	Intel Core 2 Duo or higher
RAM	4 GB or more
HDD	For installing and starting up the program: Approx. 100 MB or more of available space For saving image files: Approx. 10 MB/file (JPEG), Approx. 30 MB/file (RAW)
Monitor	1280×1024 dots, 24-bit full color or higher

























Macintosh

OS	OS X 10.11, 10.10, 10.9, 10.8, or 10.7
CPU	Intel Core 2 Duo or higher
RAM	4 GB or more
HDD	For installing and starting up the program: Approx. 100 MB or more of available space For saving image files: Approx. 10 MB/file (JPEG), Approx. 30 MB/file (RAW)
Monitor	1280×1024 dots, 24-bit full color or higher

● Memo

- Application software that supports both MOV (MPEG-4AVC/H.264) and AVI (Motion JPEG) formats is required to play back movie files transferred to a computer.

Symbols

 menus.....	24
 menus.....	29
 menu.....	30
 menus.....	31
 menus.....	34
 mode.....	54
 Portrait.....	50
 Landscape.....	50
 Macro.....	50
 Moving Object.....	50
 Night Scene Portrait ..	50
 Sunset.....	50
 Blue Sky.....	50
 Forest.....	50
 Night Scene.....	51
 Night Scene HDR.....	51
 Night Snap.....	51
 Food.....	51
 Pet.....	51
 Kids.....	51
 Surf & Snow.....	51
 Backlight Silhouette...	51
 Candlelight.....	51
 Stage Lighting.....	51
 Museum.....	51

Numerics

1st Frame Action in AF.C	
.....	61

4-way Controller Settings	
.....	63

A

AA Filter Simulator.....	81
AC adapter.....	39
Action in AF.C Continuous	
.....	61
AdobeRGB.....	49
AE Lock.....	53
AE Metering.....	58
AE-L with AF Locked.....	34
AF Active Area.....	62, 64
AF Assist Light.....	9, 62
AF coupler.....	9
AF Fine Adjustment.....	65
AF frame.....	46, 47
AF in Interval Shooting....	72
AF Mode.....	62, 63
AF point.....	62
AF with Remote Control ..	68
AFA	62
AFC	62
AFS	62
AF.S Setting.....	61, 63
AF/AE-L Button.....	107
Anti-aliasing filter.....	81
Aperture Priority Automatic	
Exposure.....	51
Aperture value.....	51
Aspect Ratio.....	88, 93

ASTROPHOTO.....	50
ASTROTRACER.....	127
Auto (AF Active Area).....	62
Auto EV Compensation... ..	34
Auto Flash + Red-eye.....	59
Auto Flash Discharge.....	59
Auto Image Rotation.....	86
AUTO mode.....	45
Auto Picture mode.....	45
Auto Power Off.....	42
Auto Select (Custom Image)	
.....	75
Auto SR Off.....	66
Auto White Balance (White	
Balance).....	72
Autofocus.....	61
AV device.....	87
Av mode.....	51
AWB in Tungsten Light....	73

B

B mode.....	51
Backlight Silhouette (SCN)	
.....	51
Base Parameter Adjustment	
(Digital Filter).....	89
Battery.....	37
Bleach Bypass (Custom	
Image).....	75
Blue Sky (SCN).....	50

Bold Monochrome (Digital	
Filter).....	77, 89
Bracketing.....	68
Bracketing Order.....	69
Bright (Custom Image)....	75
Brightness adjustment....	78
Brightness histogram.....	18
Built-in flash.....	59
Bulb (B) Mode Options....	53
Bulb Exposure.....	51, 53
Button.....	10
Button Customization....	106

C

Cable release.....	55
Cable release terminal....	55
Calendar Filmstrip Display	
.....	85
Calibration.....	127
Candlelight (SCN).....	51
Capture mode.....	50
Card.....	40
Card access lamp.....	9
Catch-in Focus.....	124
Center-weighted metering	
.....	58
Certification Marks.....	146
Changing the image size	
.....	88
Charging the battery.....	37
City names.....	42, 138

Clarity 80
 Cleaning 130
 CLEAR TONE 50
 Cloudy (White Balance)... 72
 Color Fringe Correction ... 93
 Color Moiré Correction ... 89
 Color Space..... 49
 Color Temperature (White Balance) 75
 Color Temperature Steps 75
 Communication device 97
 Communication Info 96
 Computer..... 94
 Connection cable cover... 39
 Continuous mode (AF Mode) 62
 Continuous playback 86
 Continuous Shooting 66
 Contrast (Custom Image) 76
 Contrast detection AF..... 61
 Control panel 14, 20
 Copyright Holder 117
 Copyright Information 117
 Correcting images 78
 Create New Folder 115
 Cropping 88
 Cross Processing (Custom Image) 75
CTE 72
 Custom Image 75
 Custom Setting menus 34
 Customization 21, 106

D
 Date Adjustment 43
 Date Format 43
 Daylight (White Balance) 72
 DC coupler 39
 Delete 48
 Delete All Images 30
 Deleting selected images 84
 Depth of field 53
 Destination 113
 Detailed Information Display 17
 Developing RAW images 92
 Dial 10
 Dial indicator..... 45
 Diffraction Correction..... 80
 Digital Camera Utility 5 93, 139
 Digital Filter 77, 89
 Digital Preview..... 108
 Diopter adjustment lever 19
 Direct keys..... 20
 Display Color 44
 Distortion Correction..... 80
 DNG 49
 D-Range Settings 78
 Drive Mode 65
 DST (daylight saving time) 43, 113
 Dust Removal 129

Dynamic range 78
E
 E-dial 109
 Editing images 88
 Electronic Compass 15, 126
 Electronic Level 15, 19
 Error Messages 131
 EV Compensation 58
 EV Steps 52
 Exif data 117
 Expanded Area AF (AF Active Area) 62
 Exposure modes 51, 112
 External flash 125
 External Input Devices 55
 Extract Color (Digital Filter) 77, 89
F
 Face Detection (AF Active Area)..... 64
 File Format 49
 File Name 116
 File No. 117
 Filter 77, 89
 Firmware Info/Options 33
 Fish-eye (Digital Filter) ... 89
 Flash..... 59, 125
 Flash compensation 59
 Flash On 59
 Flash On + Red-eye 59
 Flat (Custom Image)..... 75
 Flicker Reduction..... 26, 30

Fluorescent - Cool White (White Balance)..... 72
 Fluorescent - Daylight Color (White Balance)..... 72
 Fluorescent - Daylight White (White Balance)..... 72
 Fluorescent - Warm White (White Balance)..... 72
 Focus indicator 46
 Focus Method..... 61
 Focus mode switch.... 45, 61
 Focus Peaking..... 63
 Folder display 85
 Folder Name..... 115
 Food (**SCN**)..... 51
 Forest (**SCN**)..... 50
 Format 44
 Four-way controller.... 11, 20
 Framerate 49
 Function restrictions 118
 Fx1 button..... 106
 Fx2 button..... 106
G
 GPS LED Indicators 110
 GPS Time Sync..... 126
 GPS unit 126
 Grid Display 26, 48
 Guide Display 45
 Guide number 60
H
 HDMI Out..... 87
 HDR Capture 79
 HDR LANDSCAPE 50

- High Contrast (Digital Filter) 77, 89
 - High-ISO NR 57
 - Highlight Alert 16
 - Highlight Correction 78
 - High-speed Sync flash .. 126
 - Histogram Display 18
 - Hold AF Status 61
 - Hometown 42, 113
 - Horizon Correction 26
 - Hot shoe 9
- I**
- Image Capture Settings... 49
 - Image finishing tone 75
 - Image plane indicator 9
 - Image Rotation 86
 - Image storage capacity 138
 - Image Sync 97
 - Image View (Image Sync) 97
 - Indicator Lamps 110
 - Initial settings 42
 - Initializing a memory card 44
 - Input Focal Length..... 125
 - Instant Review 27, 46
 - Interval Composite 71
 - Interval Movie Record 71
 - Interval Shooting 71
 - Interval Shooting Options 72
 - Invert Color (Digital Filter) 77, 89
- J**
- ISO sensitivity 56
 - JPEG 49
 - JPEG Quality 49
 - JPEG Recorded Pixels 49
- K**
- Kelvin 75
 - Kids (**SCN**) 51
- L**
- Lamp 11
 - Landscape (**SCN**) 50
 - Landscape (Custom Image) 75
 - Language/言語 42
 - Language setting 42
 - Lateral Chromatic Aberration Adjustment 80
 - LCD Display 44
 - LCD Display Settings 32
 - Lens 36, 121
 - Lens Correction 80
 - Lens focal length 125
 - Lens information contacts 9
 - Lens mount index 36
 - Lens unlock button 37
 - Lens with aperture ring.. 123
 - Link AE and AF Point 58
 - Live View 13, 14
- M**
- M** mode 51
 - Macintosh 139
 - Macro (**SCN**) 50
 - Manual Exposure 51
 - Manual Flash Discharge.. 59
 - Manual focus 61
 - Manual White Balance 74
 - Memory 113
 - Memory card 40
 - Menu 22
 - Meter Operating Time 34
 - MF** 61
 - Microphone 9, 55
 - Microphone terminal 55
 - Microphone/cable release terminal 9
 - Miniature (Digital Filter) ... 89
 - Mired 75
 - Mirror 9
 - Mirror Lock-up Shooting .. 69
 - Mode dial 45
 - Moiré reduction 81
 - Monitor 12, 41
 - Monochrome (Custom Image) 75
 - Monochrome (Digital Filter) 89
 - Mount type 121
 - Movie Capture Settings ... 49
 - Movie Edit 91
 - Movie menus 29
 - Movie mode 54
 - Movie SR 29
 - Moving Object (**SCN**) 50
 - MSC 129
 - Multi Auto White Balance (White Balance) 72
 - Multi-exposure 70
 - Multi-image display 84
 - Multiple AF Points (AF Active Area) 64
 - Multi-segment metering ... 58
 - Museum (**SCN**) 51
 - Muted (Custom Image).... 75
- N**
- Natural (Custom Image) .. 75
 - Night Scene (**SCN**) 51
 - Night Scene HDR (**SCN**) 51
 - Night Scene Portrait (**SCN**) 50
 - Night Snap (**SCN**) 51
 - Night Vision LCD Display 128
 - Noise Reduction 52, 57
- O**
- One Push File Format ... 107
 - One-Push Bracketing 69
 - Operating environment.. 139
 - Optical Preview 108
 - Other Display Settings..... 27
 - Other Indicator Lamps... 110
 - Outdoor View Setting..... 110
- P**
- P** mode 51
 - Pastel (Digital Filter) 89
 - PEF 49

Peripheral Illumination	
Correction	80
Pet (SCN)	51
Phase-matching AF	61
Photographer	117
Pixel Mapping	130
Pixel Shift Resolution	81
Playback Info Display selection screen	16
Playback menu	30
Playback mode	47
Playback mode palette	83
Playback Sound Volume	56
Portrait (SCN)	50
Portrait (Custom Image) ..	75
Posterization (Digital Filter)	89
Power	42
Precise Calibration	127
Preview	53, 108
Processing images	88
Program Automatic Exposure	51
Protect	114
Protect All Images	114
Provided software	139
PTP	129

Q

Quality	49
Quality level adjustment ..	80
Quick Zoom	48

R

Radiant (Custom Image)	75
RAW	49
RAW Development	92
RAW File Format	49
Rec. Mode menus	24
Recordable time	54
Recorded Pixels	49
Recording Sound Level ...	55
Release While Charging..	60
Remote Capture (Image Sync)	97
Remote Control	67
Remote control receiver ...	9
Replace Color (Digital Filter)	77, 89
Reset	33, 35
Resize	88
Retractable lens	46
Retro (Digital Filter) ...	77, 89
Reversal Film (Custom Image)	75
RGB histogram	18
Rotating images	86
Rotation Direction	109

S

Save as Manual WB	74
Save Cross Processing ...	76
Save Menu Location	23
Save RAW Data	46, 48
Save Rotation Info	86
Save USER Mode	111

Scene modes	50
SCN mode	50
SD Memory Card	40
Select (AF Active Area)	62, 64
Self-timer	67
Sensitivity	56
Sensitivity Priority Automatic Exposure	51
Sensitivity Steps	56
Sensor Cleaning	130
Sequential Numbering ...	117
Set-up menus	31
Shade (White Balance) ...	72
Shading (Digital Filter)	77, 89
Shadow Correction	78
Shake Reduction	26
Sharpness (Custom Image)	76
Shooting	45
Shooting celestial bodies	127
Shooting Info Display	15
Shooting with Live View ..	47
Shooting with viewfinder..	45
Shutter & Aperture Priority Automatic Exposure	51
Shutter Priority Automatic Exposure	51
Shutter speed	51
Single Frame Shooting	65
Single image display	16, 47

Single mode (AF Mode)...	62
Sketch (Digital Filter)	89
Skin Tone	80
Slideshow	86
Slim (Digital Filter)	89
Slow Shutter Speed NR... 52	
Slow Sync + Red-eye	59
Slow-speed Sync	59
Soft (Digital Filter)	89
Sound	54
Sound Effects	31
Speaker	9
Specifications	133
Spot (AF Active Area)	62, 64
Spot metering	58
sRGB	49
Stage Lighting (SCN)	51
Standby mode	12
Star Stream	71
Starburst (Digital Filter)...	89
Status Screen	13
Strap	36
Strap lug	36
Sunset (SCN)	50
Superimpose AF Area	19
Surf & Snow (SCN)	51
Sv mode	51
Switch	10

T

TAv mode	51
Text input	112, 115
Text Size	43
Texture adjustment	80

Thumbnail display	48, 84	WB Adjustable Range	73
Time Setting	113	WB When Using Flash	73
Timed exposure.....	53	White Balance	72
Tone Expansion (Digital Filter)	89	Wi-Fi	95
Toy Camera (Digital Filter)	77, 89	Windows.....	139
Tracking (AF Active Area)	64	Wireless LAN.....	95
Trailing Curtain Sync	59	World Time	113
TTL phase-matching AF	61	Z	
Tungsten (White Balance)	72	Zoom Review	48
Tv mode.....	51		
U			
Unicolor Bold (Digital Filter)	77, 89		
USB Connection.....	94, 139		
USB terminal	94		
User registration	8		
Using Aperture Ring	123		
V			
Vibrant (Custom Image) ..	75		
Viewfinder.....	18		
Viewfinder Overlay	26		
Volume	31, 55		
Volume label.....	44		
W			
WARRANTY POLICY....	149		
Water Color (Digital Filter)	89		

Care to be Taken During Handling

Before Using Your Camera

- When the camera has not been used for a long time, confirm that it is still working properly, particularly prior to taking important pictures (such as at a wedding or when traveling). Contents of the recording cannot be guaranteed if recording, playback or transferring your data to a computer, etc. is not possible due to a malfunction of your camera or recording media (memory cards), etc.

About the Battery and Charger

- To keep the battery in optimum condition, avoid storing it in a fully charged state or in high temperatures.
- If the battery is left inserted and the camera is not used for a long time, the battery will over-discharge and shorten the battery's life.
- Charging the battery a day before use or on the day of use is recommended.
- The AC plug cord provided with this camera is developed exclusively for the battery charger D-BC109. Do not use it with other devices.

Precautions on Carrying and Using Your Camera

- Do not subject the camera to high temperatures or high humidity. Do not leave the camera in a vehicle, as the temperature can get very high.
- Do not subject the camera to strong vibrations, shocks, or pressure. Use a cushion to protect the camera from vibrations of motorcycles, automobiles, or ships.
- The temperature range for camera use is -10°C to 40°C (14°F to 104°F).
- The monitor may appear black at high temperatures, but will return to normal at normal temperatures.
- The monitor may respond more slowly at low temperatures. This is due to liquid crystal properties, and is not a malfunction.

- Sudden temperature changes will cause condensation on the inside and outside of the camera. Place the camera in your bag or a plastic bag, and remove it after temperatures of the camera and surroundings are equalized.
- Avoid contact with garbage, mud, sand, dust, water, toxic gases, or salt. These could cause the camera to breakdown. Wipe the camera to dry off any rain or water drops immediately.
- Do not attach or remove a lens when there are any rain or water drops on the camera. If water enters the camera or the lens, a malfunction may occur.
- Do not press on the monitor with excessive force. This could cause it to break or malfunction.
- Be careful not to overtighten the screw in the tripod socket when using a tripod.

Cleaning Your Camera

- Do not clean the camera with organic solvents such as thinner, alcohol, and benzine.
- Use a lens brush to remove dust accumulated on a lens. Never use a spray blower for cleaning as it may damage the lens.
- Please contact your nearest service center for professional cleaning of the CMOS sensor. (This will involve a fee.)
- Periodic inspections are recommended every one to two years to maintain high performance.

Storing Your Camera

- Do not store the camera with preservatives or chemicals. Storage in high temperatures and high humidity can cause mold to grow on the camera. Remove the camera from its case and store it in a dry and well-ventilated place.
- Avoid using or storing the camera where it may be exposed to static electricity or electrical interference.
- Avoid using or storing the camera in direct sunlight or in locations where it may be exposed to rapid changes in temperature or to condensation.

About SD Memory Cards

- The SD Memory Card is equipped with a write-protect switch. Setting the switch to LOCK prevents new data from being recorded on the card, the stored data from being deleted, and the card from being formatted by the camera or computer.
- The SD Memory Card may be hot when removing the card immediately after using the camera.
- Do not remove the SD Memory Card or turn off the power while the card is being accessed. This may cause the data to be lost or the card to be damaged.
- Do not bend the SD Memory Card or subject it to violent impact. Keep it away from water and store away from high temperatures.
- Do not remove the SD Memory Card while formatting. The card may be damaged and become unusable.
- Data on the SD Memory Card may be deleted in the following circumstances. We do not accept any liability for data that is deleted if
 1. the SD Memory Card is mishandled by the user.
 2. the SD Memory Card is exposed to static electricity or electrical interference.
 3. the SD Memory Card has not been used for a long time.
 4. the SD Memory Card or the battery is removed while the card is being accessed.
- If the SD Memory Card is not used for a long time, the data on the card may become unreadable. Be sure to regularly make a backup of important data on a computer.
- Format new SD Memory Cards. Also format SD Memory Cards previously used with other cameras.
- Please note that deleting data stored on an SD Memory Card, or formatting an SD Memory Card does not completely erase the original data. Deleted data can sometimes be recovered using commercially available software. If you are going to discard, give away or sell your SD Memory Card, you should ensure that the data on the card is completely deleted or the card itself is destroyed if it contains any personal or sensitive information.
- The data on your SD Memory Card should be managed at your own risk.

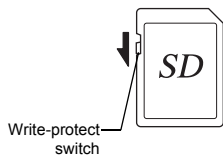

About the Wireless LAN Function

- Do not use the camera in a place where electrical products, AV/OA devices, and so on generate magnetic fields and electromagnetic waves.
- If the camera is affected by magnetic fields and electromagnetic waves, it may not be able to communicate.
- If the camera is used near a TV or a radio, poor reception or TV screen glitch may occur.
- If there are multiple wireless LAN access points near the camera and the same channel is used, search operation may not be executed correctly.
- The security of your data stored, sent or received is your own responsibility.

In the frequency band used by the camera, along with industrial, scientific, and medical devices such as microwave ovens, premises radio stations (wireless stations requiring license) and specified low power radio stations (wireless stations not requiring license) for mobile object identification used in factory production lines, etc., and amateur radio stations (wireless stations requiring license) are operated.

1. Before using the camera, confirm that premises radio stations and specified low power radio stations for mobile object identification and amateur radio stations are not operated in the vicinity.
2. In the event that the camera causes harmful radio wave interference to premises radio stations for mobile object identification, immediately change the frequency being used to avoid interference.
3. If you have other troubles such that the camera causes harmful radio wave interference to specified low power radio stations for mobile object identification or to amateur radio stations, contact your nearest service center.

This camera conforms to the technical standards under the Radio Law and Telecommunications Business Law and the certification of conformance to technical standards can be displayed on the monitor.

The certification marks of conformance to wireless technical standards under the Radio Law and Telecommunications Business Law can be displayed from [Certification Marks] of the 5 menu. Refer to "Using the Menus" (p.22) for how to use the menus.

Trademarks

- Microsoft and Windows are registered trademarks of Microsoft Corporation in the United States of America and other countries.
- Macintosh, OS X, QuickTime, and App Store are trademarks of Apple Inc., registered in the U.S. and other countries.
- Intel and Intel Core are trademarks of Intel Corporation in the U.S. and/or other countries.
- SDXC Logo is a trademark of SD-3C, LLC.
- Google, Google Play, and Android are trademarks or registered trademarks of Google Inc.
- Wi-Fi is a registered trademark of Wi-Fi Alliance.
- IOS is a trademark or registered trademark of Cisco in the U.S. and other countries and is used under license.
- This product includes DNG technology under license by Adobe Systems Incorporated.
- The DNG logo is either a registered trademark or trademark of Adobe Systems Incorporated in the United States and/or other countries.
- HDMI, the HDMI logo and High-Definition Multimedia Interface are trademarks or registered trademarks of HDMI Licensing, LLC in the United States and/or other countries.

All other trademarks are the property of their respective owners.

- This product uses the RICOH RT font designed by Ricoh Company Ltd.
- This product supports PRINT Image Matching III. PRINT Image Matching enabled digital still cameras, printers and software help photographers to produce images more faithful to their intentions. Some functions are not available on printers that are not PRINT Image Matching III compliant.

Copyright 2001 Seiko Epson Corporation. All Rights Reserved. PRINT Image Matching is a trademark of Seiko Epson Corporation. The PRINT Image Matching logo is a trademark of Seiko Epson Corporation.

HDMITM
HIGH-DEFINITION MULTIMEDIA INTERFACE

SDTM
XC I

 **SILKYPIX**[®]

DNGTM

AVC Patent Portfolio License

This product is licensed under the AVC Patent Portfolio License for the personal use of a consumer or other uses in which it does not receive remuneration to (i) encode video in compliance with the AVC standard ("AVC video") and/or (ii) decode AVC video that was encoded by a consumer engaged in a personal activity and/or was obtained from a video provider licensed to provide AVC video. No license is granted or shall be implied for any other use.

Additional information may be obtained from MPEG LA, L.L.C.
See <http://www.mpegla.com>.

Announcement on the Use of BSD-Licensed Software

This product includes software licensed under the BSD License. BSD license is a form of license which permits the redistribution of the software provided that it is clearly stated that use is unwarranted, and a copyright notice and a list of licensing conditions are provided. The following contents are displayed based on the abovementioned licensing conditions and are not for the purpose of restricting your use of the product, etc.

Tera Term

Copyright (C) 1994-1998 T. Teranishi

(C) 2004-2016 TeraTerm Project

All rights reserved.

Redistribution and use in source and binary forms, with or without modification, are permitted provided that the following conditions are met:

1. Redistributions of source code must retain the above copyright notice, this list of conditions and the following disclaimer.
2. Redistributions in binary form must reproduce the above copyright notice, this list of conditions and the following disclaimer in the documentation and/or other materials provided with the distribution.
3. The name of the author may not be used to endorse or promote products derived from this software without specific prior written permission.

THIS SOFTWARE IS PROVIDED BY THE AUTHOR "AS IS" AND ANY EXPRESS OR IMPLIED WARRANTIES, INCLUDING, BUT NOT LIMITED TO, THE IMPLIED WARRANTIES OF MERCHANTABILITY AND FITNESS FOR A PARTICULAR PURPOSE ARE DISCLAIMED. IN NO EVENT SHALL THE AUTHOR BE LIABLE FOR ANY DIRECT, INDIRECT, INCIDENTAL, SPECIAL, EXEMPLARY, OR CONSEQUENTIAL DAMAGES (INCLUDING, BUT NOT LIMITED TO, PROCUREMENT OF SUBSTITUTE GOODS OR SERVICES; LOSS OF USE, DATA, OR PROFITS; OR BUSINESS INTERRUPTION) HOWEVER CAUSED AND ON ANY THEORY OF LIABILITY, WHETHER IN CONTRACT, STRICT LIABILITY, OR TORT (INCLUDING NEGLIGENCE OR OTHERWISE) ARISING IN ANY WAY OUT OF THE USE OF THIS SOFTWARE, EVEN IF ADVISED OF THE POSSIBILITY OF SUCH DAMAGE.

WARRANTY POLICY

All our cameras purchased through authorized bona fide photographic distribution channels are guaranteed against defects of material or workmanship for a period of twelve months from the date of your purchase. Service will be rendered, and defective parts will be replaced without cost to you within that period, provided the camera does not show evidence of impact, sand or liquid damage, mishandling, tampering, battery or chemical corrosion, operation contrary to operating instructions, or modification by an unauthorized repair shop. The manufacturer or its authorized representatives shall not be liable for any repair or alterations except those made with its written consent and shall not be liable for damages from delay or loss of use or from other indirect or consequential damages of any kind, whether caused by defective material or workmanship or otherwise; and it is expressly agreed that the liability of the manufacturer or its representatives under all guarantees or warranties, whether expressed or implied, is strictly limited to the replacement of parts as hereinbefore provided. No refunds will be made on repairs by non-authorized service facilities.

Procedure During 12-month Warranty Period

Any camera which proves defective during the 12-month warranty period should be returned to the dealer from whom you purchased the camera or to the manufacturer. If there are no representatives of the manufacturer in your country, send the camera to the manufacturer, with postage prepaid. In this case, it will take a considerable length of time before the camera can be returned to you owing to the complicated customs procedures required. If the camera is covered by warranty, repairs will be made and parts replaced free of charge, and the

camera will be returned to you upon completion of servicing. If the camera is not covered by warranty, regular charges of the manufacturer or of its representatives will apply. Shipping charges are to be borne by the owner. If your camera was purchased outside of the country where you wish to have it serviced during the warranty period, regular handling and servicing fees may be charged by the manufacturer's representatives in that country. Notwithstanding this, your camera returned to the manufacturer will be serviced free of charge according to this procedure and warranty policy. In any case, however, shipping charges and customs clearance fees to be borne by the sender. To prove the date of your purchase when required, please keep the receipt or bills covering the purchase of your camera for at least a year. Before sending your camera for servicing, please make sure that you are sending it to the manufacturer's authorized representatives or their approved repair shops, unless you are sending it directly to the manufacturer. Always obtain a quotation for the service charge, and only after you accept the quoted service charge, instruct the service station to proceed with the servicing.

- **This warranty policy does not affect the customer's statutory rights.**
- **The local warranty policies available from our distributors in some countries can supersede this warranty policy. Therefore, we recommend that you review the warranty card supplied with your product at the time of purchase, or contact our distributor in your country for more information and to receive a copy of the warranty policy.**

For customers in USA

STATEMENT OF FCC COMPLIANCE

This device complies with Part 15 of the FCC Rules. Operation is subject to the following two conditions: (1) This device may not cause harmful interference, and (2) this device must accept any interference received, including interference that may cause undesired operation. Changes or modifications not approved by the party responsible for compliance could void the user's authority to operate the equipment.

This equipment has been tested and found to comply with the limits for a Class B digital device, pursuant to part 15 of the FCC Rules.

These limits are designed to provide reasonable protection against harmful interference in a residential installation. This equipment generates, uses and can radiate radio frequency energy and, if not installed and used in accordance with the instructions, may cause harmful interference to radio communications. However, there is no guarantee that interference will not occur in a particular installation. If this equipment does cause harmful interference to radio or television reception, which can be determined by turning the equipment off and on, the user is encouraged to try to correct the interference by one or more of the following measures:

- Reorient or relocate the receiving antenna.
- Increase the separation between the equipment and receiver.
- Connect the equipment into an outlet on a circuit different from that to which the receiver is connected.

* Consult the dealer or an experienced radio/TV technician for help.

FOR CALIFORNIA, U.S.A. ONLY

Perchlorate Material-special handling may apply.
The lithium battery used in this camera contains perchlorate material, which may require special handling.
See www.dtsc.ca.gov/hazardouswaste/perchlorate

Declaration of Conformity

According to 47CFR, Parts 2 and 15 for
Class B Personal Computers and Peripherals

We: RICOH IMAGING AMERICAS
CORPORATION

Located at: 633 17th Street, Suite 2600
Denver, Colorado 80202 U.S.A.
Phone: 800-877-0155
FAX: 303-790-1131

Declare under sole responsibility that the product identified herein complies with 47CFR Parts 2 and 15 of the FCC rules as a Class B digital device. Each product marketed is identical to the representative unit tested and found to be compliant with the standards. Records maintained continue to reflect the equipment being produced can be expected to be within the variation accepted, due to quantity production and testing on the statistical basis as required by 47CFR §2.909. Operation is subject to the following two conditions: (1) This device may not cause harmful interference, and (2) This device must accept any interference received, including interference that may cause undesired operation. The above named party is responsible for ensuring that the equipment complies with the standards of 47CFR §15.101 to §15.109.

Product Name: SLR Digital Camera

Model Number: PENTAX K-70

Contact person: Customer Service Manager

Date and Place: April, 2016 Colorado

For customers in Canada
Industry Canada (IC) Compliance Notice

This Class B digital apparatus complies with Canadian ICES-003 (B).

This device complies with Industry Canada licence-exempt RSS standard(s). Operation is subject to the following two conditions: (1) this device may not cause interference, and (2) this device must accept any interference, including interference that may cause undesired operation of the device.

The available scientific evidence does not show that any health problems are associated with using low power wireless devices. There is no proof, however, that these low power wireless devices are absolutely safe. Low power wireless devices emit low levels of radio frequency energy (RF) in the microwave range while being used. Whereas high levels of RF can produce health effects (by heating tissue), exposure of low-level RF that does not produce heating effects causes no known adverse health effects. Many studies of low-level RF exposures have not found any biological effects. Some studies have suggested that some biological effects might occur, but such findings have not been confirmed by additional research. The K-70 has been tested and found to comply with IC radiation exposure limits set forth for an uncontrolled environment and meets RSS-102 of the IC radio frequency (RF) Exposure rules.

Pour les utilisateurs au Canada
Industrie Canada (IC) Avis de Conformité

Cet appareil numérique de la classe B est conforme à la norme NMB-003 (B) du Canada.

Le présent appareil est conforme aux CNR d'Industrie Canada applicables aux appareils radio exempts de licence. L'exploitation est autorisée aux deux conditions suivantes : (1) l'appareil ne doit pas produire de brouillage, et (2) l'utilisateur de l'appareil doit accepter tout brouillage radioélectrique subi, même si le brouillage est susceptible d'en compromettre le fonctionnement.

Les connaissances scientifiques dont nous disposons n'ont mis en évidence aucun problème de santé associé à l'usage des appareils sans fil à faible puissance. Nous ne sommes cependant pas en mesure de prouver que ces appareils sans fil à faible puissance sont entièrement sans danger. Les appareils sans fil à faible puissance émettent une énergie fréquence radioélectrique (RF) très faible dans le spectre des micro-ondes lorsqu'ils sont utilisés. Alors qu'une dose élevée de RF peut avoir des effets sur la santé (en chauffant les tissus), l'exposition à de faibles RF qui ne produisent pas de chaleur n'a pas de mauvais effets connus sur la santé. De nombreuses études ont été menées sur les expositions aux RF faibles et n'ont découvert aucun effet biologique. Certaines études ont suggéré qu'il pouvait y avoir certains effets biologiques, mais ces résultats n'ont pas été confirmés par des recherches supplémentaires. Le K-70 a été testé et jugé conforme aux limites d'exposition aux rayonnements IC énoncées pour un environnement non contrôlé et respecte les règles d'exposition aux fréquences radioélectriques (RF) CNR-102 de l'IC.

For Customers in Europe

Information for Users on Collection and Disposal of Old Equipment and Used Batteries



1. In the European Union

These symbols on the products, packaging and/or accompanying documents mean that used electrical and electronic equipment and batteries should not be mixed with general household waste.

Used electrical/electronic equipment and batteries must be treated separately and in accordance with legislation that requires proper treatment, recovery and recycling of these products.



By disposing of these products correctly you will help ensure that the waste undergoes the necessary treatment, recovery and recycling and thus prevent potential negative effects on the environment and human health which could otherwise arise due to inappropriate waste handling.

If a chemical symbol is added beneath the symbol shown above, in accordance with the Battery Directive, this indicates that a heavy metal (Hg = Mercury, Cd = Cadmium, Pb = Lead) is present in the battery at a concentration above an applicable threshold specified in the Battery Directive.

For more information about collection and recycling of used products, please contact your local authorities, your waste disposal service or the point of sale where you purchased the products.

2. In other countries outside the EU

These symbols are only valid in the European Union. If you wish to discard used products, please contact your local authorities or dealer and ask for the correct method of disposal.

For Switzerland: Used electrical/electronic equipment can be returned free of charge to the dealer, even when you don't purchase a new product. Further collection facilities are listed on the home page of www.swico.ch or www.sens.ch.

Notice to Users in EEA Countries

This product complies with the essential requirements and provisions of RE Directive 2014/53/EU.

The CE Declaration of Conformity is available by accessing the URL:

<http://www.ricoh-imaging.co.uk/en/Photo-Downloads.html>
and selecting the product applicable.

Operating frequency band: 2400 MHz - 2483.5 MHz
Maximum radio-frequency power: 8.16 dBm EIRP

European importer: RICOH IMAGING EUROPE S.A.S.
Parc Tertiaire SILIC 7-9, avenue Robert Schuman - B.P. 70102,
94513 Rungis Cedex, FRANCE
(<http://www.ricoh-imaging.eu>)

Manufacturer: RICOH IMAGING COMPANY, LTD.
1-3-6, Nakamagome, Ohta-ku, Tokyo 143-8555, JAPAN
(<http://www.ricoh-imaging.co.jp>)



The CE Mark is a Directive conformity mark of the European Union.

Memo

RICOH IMAGING COMPANY, LTD.

1-3-6, Nakamagome, Ohta-ku, Tokyo 143-8555, JAPAN
(<http://www.ricoh-imaging.co.jp>)

**RICOH IMAGING EUROPE
S.A.S.**

Parc Tertiaire SILIC 7-9, avenue Robert Schuman - B.P. 70102,
94513 Rungis Cedex, FRANCE
(<http://www.ricoh-imaging.eu>)

**RICOH IMAGING AMERICAS
CORPORATION**

633 17th Street, Suite 2600, Denver, Colorado 80202, U.S.A.
(<http://www.us.ricoh-imaging.com>)

**RICOH IMAGING CANADA
INC.**

5520 Explorer Drive Suite 300, Mississauga, Ontario, L4W 5L1, CANADA
(<http://www.ricoh-imaging.ca>)

**RICOH IMAGING CHINA CO.,
LTD.**

23D, Jun Yao International Plaza, 789 Zhaojiabang Road, Xu Hui District,
Shanghai, 200032, CHINA
(<http://www.ricoh-imaging.com.cn>)

<http://www.ricoh-imaging.co.jp/english>

This contact information may change without notice.
Please check the latest information on our websites.

- Specifications and external dimensions are subject to change without notice.