

RICOH

SLR Digital Camera

PENTAX *K-3 II*

Operating Manual

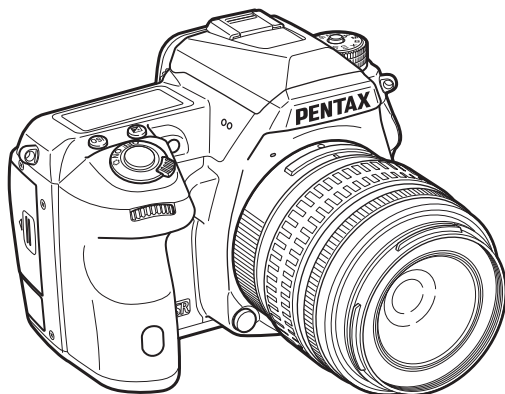

Introduction **1**

Getting Started **2**

Shooting **3**

Playback **4**

Settings **5**

Appendix **6**

To ensure the best performance from your camera, please read the Operating Manual before using the camera.

Checking the Contents of the Package



Hot shoe cover Fk
(Installed on camera)



Eyecup Fs
(Installed on camera)



ME viewfinder cap



Sync socket 2P cap
(Installed on camera)

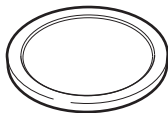

Body mount cover
(Installed on camera)



Triangular ring and protective
cover (Installed on camera)



Battery grip terminal cover
(Installed on camera)

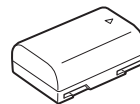

Rechargeable lithium-ion
battery D-L190

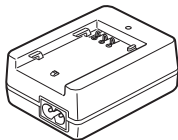

Battery charger
D-BC90



AC plug cord

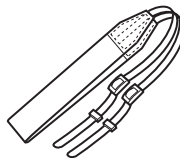

Strap
O-ST132



Software (CD-ROM)
S-SW160



Operating Manual (this manual)

Lenses you can use

Lenses that can be used with this camera are DA, DA L, D FA and FA J lenses and lenses that have an **A** (Auto) position on the aperture ring. To use any other lens or accessory, see p.89.

Introducing the K-3 II

1

Getting Started

2

Taking Pictures

3

Playback Functions

4

Changing the Settings

5

Appendix

6

1

Introducing the K-3 II p.7

Gives you an overview of the K-3 II.
Read this and get to know your K-3 II!

- Names and Functions of the Working Parts . p.7**
- How to Change Function Settings p.18**
- Menu List p.20**

2

Getting Started..... p.29

Explains how to get your K-3 II ready for shooting as well as basic operations.

- Attaching the Strap p.27**
- Attaching a Lens p.27**
- Using the Battery and Charger p.28**
- Inserting a Memory Card p.30**
- Initial Settings p.31**
- Basic Shooting Operation p.33**
- Reviewing Images p.36**

3

Taking Pictures p.39

Once you've confirmed that the camera works properly, try out the camera and take lots of pictures!

- Configuring the Capture Settings p.37**
- Taking Still Pictures p.38**
- Recording Movies p.40**
- Setting the Exposure p.41**
- Using a Flash p.43**
- Setting the Focus Method p.44**
- Setting the Drive Mode p.48**
- Setting the White Balance p.54**
- Controlling the Image Finishing Tone p.56**
- Correcting Images p.59**
- Using the GPS p.62**

4

Playback Functions..... p.67

Explains various operations for playing back and editing images.

- Playback Mode Palette Items** p.66
- Changing the Playback Method** p.67
- Connecting the Camera to a Computer** p.71
- Editing and Processing Images** p.72

5

Changing the Settings..... p.79

Explains how to change other settings.

- Camera Settings** p.78
- File Management Settings** p.82

6

Appendix p.88

Provides other resources to get the most from your K-3 II.

- Restrictions on the Combinations of Special Functions** p.87
- Functions Available with Various Lenses** p.88
- Functions when Using an External Flash** p.91
- Troubleshooting** p.92
- Main Specifications** p.96
- Index** p.102
- For Using Your Camera Safely** p.106
- Care to be Taken During Handling** p.107
- WARRANTY POLICY** p.111

There is a possibility that the illustrations and the display screen of the monitor in this manual are different from the actual ones.

How to Use This Manual	2
Introducing the K-3 II	7
Names and Functions of the Working Parts	7
Operating Controls	8
Monitor Display	10
Viewfinder	16
LCD Panel	17
Electronic Level	17
How to Change Function Settings	18
Using the Direct Keys	18
Using the Control Panel	18
Using the Menus	19
Menu List	20
Rec. Mode Menus	20
Movie Menu	23
Playback Menu	24
Set-up Menus	25
Custom Setting Menus	27
Getting Started	29
Attaching the Strap	29
Attaching a Lens	29
Using the Battery and Charger	30
Charging the Battery	30
Inserting/Removing the Battery	31
Using the AC Adapter	32
Inserting a Memory Card	32
Initial Settings	33
Turning the Camera On	33
Setting the Display Language	33
Setting the Date and Time	34
Formatting a Memory Card	35

Basic Shooting Operation	35
Shooting with the Viewfinder	35
Shooting with Live View	37
Reviewing Images	38
Taking Pictures	39
Configuring the Capture Settings	39
Memory Card Settings	39
Image Capture Settings	39
Movie Capture Settings	39
Taking Still Pictures	40
EV Compensation	41
Recording Movies	42
Playing Back Movies	43
Setting the Exposure	43
Sensitivity	43
AE Metering	44
Using a Flash	45
Connecting a Flash	45
Setting the Flash Mode	45
Setting the Focus Method	46
Setting the AF Mode when Shooting with the Viewfinder	46
Setting the AF Mode during Live View	48
AF Fine Adjustment	49
Checking the Depth of Field (Preview)	49
Setting the Drive Mode	50
Continuous Shooting	51
Self-timer	51
Remote Control	52
Exposure Bracketing	52
Mirror Lock-up Shooting	53
Multi-exposure	53
Interval Shooting	54
Interval Composite	54
Interval Movie Record	55

Setting the White Balance	56	Changing the Settings	79
Adjusting the White Balance Manually	57	Camera Settings	79
Adjusting the White Balance with Color Temperature	57	Customizing the Button/E-dial Functions	79
Controlling the Image Finishing Tone	58	Saving Frequently Used Settings	81
Custom Image	58	Displaying the Local Date and Time of the Specified City	82
Digital Filter	59	Selecting Settings to Save in the Camera	83
Correcting Images	60	File Management Settings	83
Brightness Adjustment	60	Protecting Images from Deletion (Protect)	83
Lens Correction	61	Selecting the Folder/File Settings	84
High-Definition Image Output	61	Setting the Copyright Information	86
Anti-Aliasing Filter Simulator	62	Using a Wireless Memory Card	86
Composition Adjustment	62	Appendix.....	88
Using the GPS	63	Restrictions on the Combinations of Special Functions	88
Setting Additional Features for the GPS Operation	64	Functions Available with Various Lenses	89
Performing a Calibration	64	Using the Aperture Ring	90
Recording the Camera Route (GPS Logging)	65	Setting the Focal Length	91
Shooting Celestial Bodies (ASTROTRACER)	66	Functions when Using an External Flash	91
Playback Functions	67	Troubleshooting	92
Playback Mode Palette Items	67	Sensor Cleaning	93
Changing the Playback Method	68	Error Messages	94
Displaying Multiple Images	68	Main Specifications	96
Displaying Images by Folder	69	Operating Environment for USB Connection and Provided Software	101
Displaying Images by Shooting Date	69	Index	102
Playing Back Images Continuously (Slideshow)	69	For Using Your Camera Safely	106
Displaying Rotated Images	70	Care to be Taken During Handling	107
Connecting the Camera to an AV Device	70	WARRANTY POLICY	110
Connecting the Camera to a Computer	71		
Editing and Processing Images	72		
Copying an Image	72		
Changing the Image Size	72		
Correcting Color Moiré	73		
Processing Images with Digital Filters	74		
Creating a Composite Image (Index)	75		
Editing Movies	76		
Developing RAW Images	77		

Regarding copyrights

Images taken with this camera that are for anything other than personal enjoyment cannot be used without permission according to the rights as specified in the Copyright Act. Please take care, as there are cases where limitations are placed on taking pictures even for personal enjoyment during demonstrations, performances or of items on display. Images taken with the purpose of obtaining copyrights also cannot be used outside the scope of use of the copyright as laid out in the Copyright Act, and care should be taken here also.

To users of this camera

- Do not use or store this camera in the vicinity of equipment that generates strong electromagnetic radiation or magnetic fields. Strong static charges or the magnetic fields produced by equipment such as radio transmitters could interfere with the monitor, damage the stored data, or affect the camera's internal circuitry and cause camera misoperation.
- The liquid crystal panel used for the monitor is manufactured using extremely high precision technology. Although the level of functioning pixels is 99.99% or better, you should be aware that 0.01% or fewer of the pixels may not illuminate or may illuminate when they should not. However, this has no effect on the recorded image.
- In this manual, the generic term "computer(s)" refers to either a Windows PC or a Macintosh.
- In this manual, the term "battery(ies)" refers to any type of batteries used for this camera and its accessories.

Regarding User Registration

In order to better serve you, we request that you complete the user registration, which can be found on the CD-ROM supplied with the camera or on our website.

Thank you for your cooperation.

<http://www.ricoh-imaging.com/registration/>

Names and Functions of the Working Parts

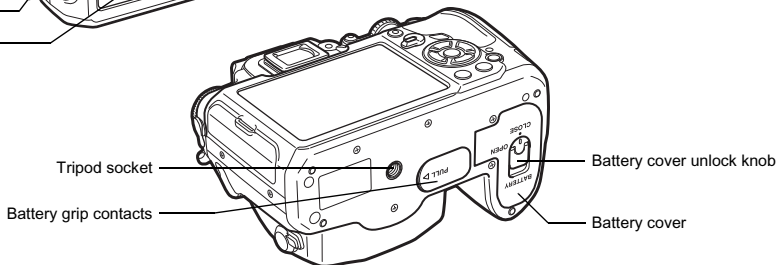
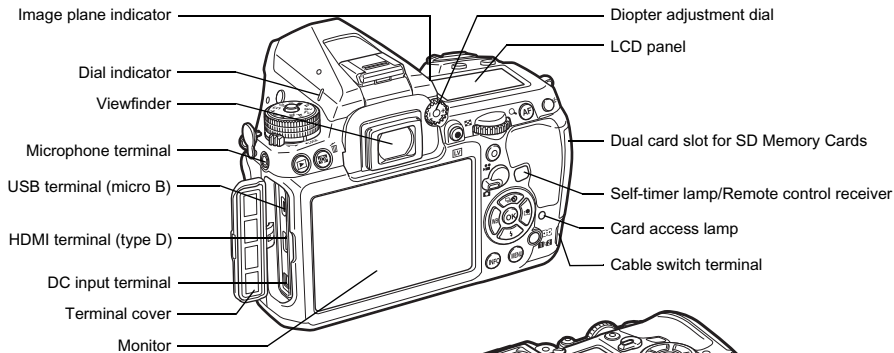
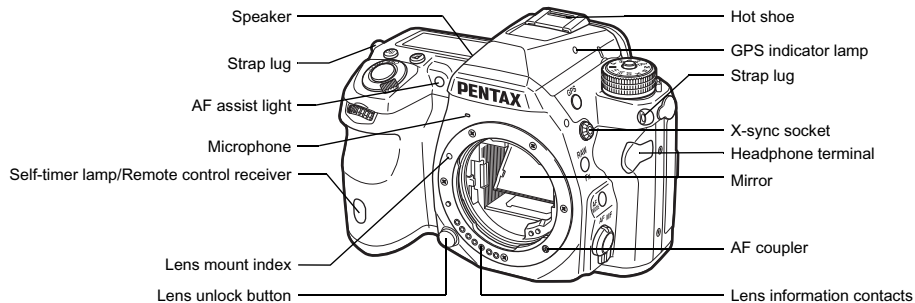

Operating Controls

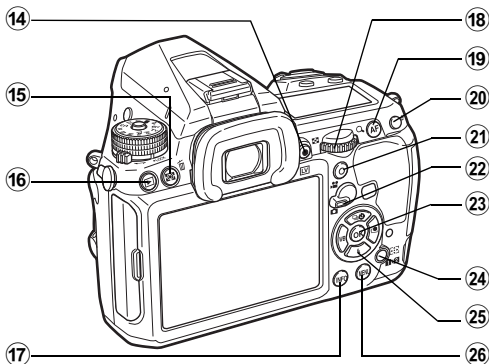
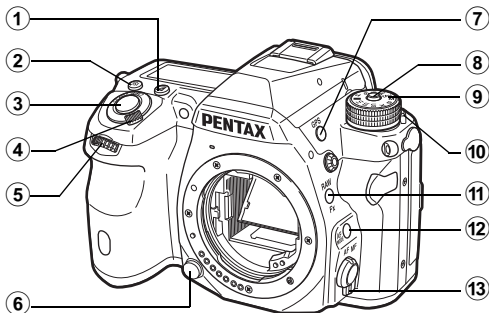

① EV Compensation button (Z)

Press to change the exposure compensation value. (p.41)

② ISO button (ISO)

Press to change the ISO sensitivity. (p.43)

③ Shutter release button

Press to capture images. (p.36)

In playback mode, press halfway to switch to capture mode.

④ Main switch

Turns the power on/off, or activates the preview function. (p.33, p.49)

⑤ Front e-dial (☀)

Changes the values for camera settings such as exposure. (p.41)

You can change the menu category when a menu screen is displayed. (p.19)

In playback mode, use this to select a different image.

⑥ Lens unlock button

Press to detach the lens on the camera. (p.29)

⑦ GPS button (GPS)

Turns the GPS function on/off. (p.63)

⑧ Mode dial lock button

Press to allow the mode dial to be turned. (p.36)

⑨ Mode dial

Changes the exposure mode. (p.36)

⑩ Mode dial lock release lever

Use this lever to release the mode dial lock to operate the mode dial without pressing the mode dial lock button. (p.37)

⑪ RAW/Fx button (RAW/Fx)

You can assign a function to this button. (p.79)

⑫ AF Mode button (AF MODE)

Press to change the autofocus mode or the focusing area. (p.46)

⑬ Focus mode switch

Changes the focus mode. (p.46)

⑭ Live View/REC button (LV/REC)

Displays the Live View image. (p.37)

Starts/stops recording a movie in mode. (p.42)

⑮ AE Metering/Delete button (AE/☒)

Press to change the metering method. (p.44)

In playback mode, press to delete images. (p.38)

- 16 Playback button (⏮)**
Switches to playback mode. (p.38) Press the button again to switch to capture mode.
- 17 INFO button (INFO)**
Changes the style of the display on the monitor. (p.10, p.14)
- 18 Rear e-dial (🔍)**
Changes the values for camera settings such as exposure. (p.40)
You can change the menu tabs when a menu screen is displayed. (p.19)
You can change the camera settings when the control panel is displayed. (p.18)
In playback mode, use this to magnify the image or display multiple images at the same time. (p.38, p.68)
- 19 AF button (AF)**
Available for adjusting focus, instead of pressing the shutter release button halfway. (p.46)
- 20 AE Lock button (AEL)**
Locks the exposure value before shooting.
In playback mode, the last JPEG image taken can also be saved in RAW format. (p.38)
- 21 Green button (O)**
Resets the value being adjusted.
Switches to ISO AUTO when adjusting the sensitivity.
- 22 Capture mode selector switch**
Switches between 📷 (still picture) mode and 🎬 (movie) mode. (p.35)
- 23 OK button (OK)**
When a menu or the control panel is displayed, press this button to confirm the selected item.
- 24 Change AF Point/Card slot switch button (Ⓜ/1/2)**
Enables changing the focusing area. (p.47)
In playback mode, press this button to switch between the memory cards inserted in the two slots, SD1 and SD2. (p.38)
- 25 Four-way controller (▲▼◀▶)**
Displays the Drive Mode/Flash Mode/White Balance/Custom Image setup menu. (p.18)

When a menu or the control panel is displayed, use this to move the cursor or change the item to set.
Press ▼ in single image display of the playback mode to display the playback mode palette. (p.67)
When selecting an area of the image to magnify or to use as a focusing area, you can move the area diagonally by pressing two keys at the same time.

- 26 MENU button (MENU)**
Displays a menu. Press this button while the menu is displayed to return to the previous screen. (p.19)

About the Four-way Controller

In this manual, each button of the four-way controller is indicated as shown in the illustration on the right.

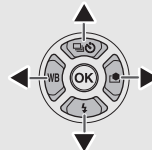

Monitor Display

Capture Mode

With this camera, you can take pictures while looking through the viewfinder or while viewing the image on the monitor. When using the viewfinder, you can take pictures while checking the status screen displayed on the monitor and looking through the viewfinder. (p.35) When not using the viewfinder, you can take pictures while viewing the Live View image displayed on the monitor. (p.37)

The camera is in “standby mode” when it is ready to shoot, such as when the status screen or Live View image is displayed. Press **INFO** in standby mode to display the “control panel” and change settings. (p.18) You can change the type of information displayed in standby mode by pressing **INFO** while the control panel is displayed. (p.13)

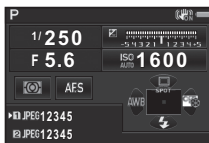

Standby mode
(Status screen)

INFO

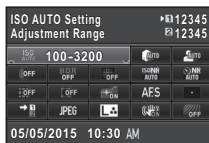

Control panel



INFO

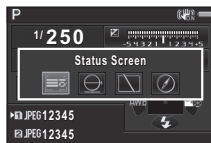

Shooting Info Display
selection screen

Status Screen

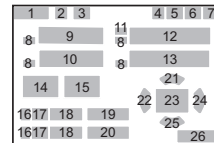

- 1 Exposure Mode (p.40)
- 2 AE Lock
- 3 Digital Filter (p.59)/HDR Capture (p.60)/Pixel Shift Resolution (p.61)
- 4 Wireless LAN status
- 5 GPS positioning status (p.86)
- 6 Shake Reduction/ Horizon Correction
- 7 Battery level
- 8 E-dial guide
- 9 Shutter speed
- 10 Aperture value
- 11 EV Compensation (p.41)/Exposure Bracketing (p.52)
- 12 EV bar scale
- 13 Sensitivity (p.43)
- 14 AE Metering (p.44)
- 15 Focus Method (p.46)
- 16 Card slot number
- 17 File Format (p.39)
- 18 Image storage capacity
- 19 Flash Exposure Compensation (p.45)
- 20 White Balance fine-tuning (p.56)
- 21 Drive Mode (p.50)
- 22 White Balance (p.56)
- 23 Focusing area (AF point) (p.47)
- 24 Custom Image (p.58)
- 25 Flash Mode (p.45)
- 26 Operation guide, and number of shots during Multi-exposure, Interval Shooting or Interval Composite

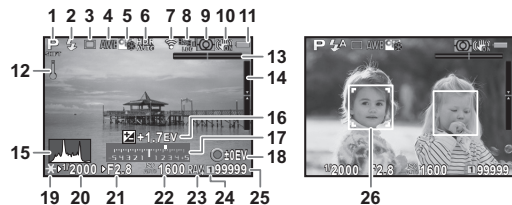

- | | |
|--|--|
| 1 Exposure Mode (p.40) | 13 Electronic Level (horizontal tilt) (p.17) |
| 2 Flash Mode (p.45) | 14 Electronic Level (vertical tilt) (p.17) |
| 3 Drive Mode (p.50) | 15 Histogram |
| 4 White Balance (p.56) | 16 EV Compensation (p.41) |
| 5 Custom Image (p.58) | 17 EV bar scale |
| 6 Digital Filter (p.59)/HDR Capture (p.60)/Pixel Shift Resolution (p.61) | 18 Operation guide |
| 7 Wireless LAN status (p.86) | 19 AE Lock |
| 8 GPS positioning status (p.63) | 20 Shutter speed |
| 9 AE Metering (p.44) | 21 Aperture value |
| 10 Shake Reduction/ Horizon Correction/ Movie SR | 22 Sensitivity (p.43) |
| 11 Battery level | 23 File Format |
| 12 Temperature warning | 24 Card slot number in use |
| | 25 Image storage capacity |
| | 26 Face detection frame (when [Contrast AF] is set to [Face Detection]) (p.48) |

Memo

- In [Live View] of the menu, you can change the settings of the items displayed on the monitor during Live View. (p.21)

Control Panel

mode

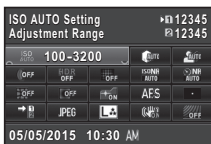

1	3	4		
2	3	4		
5	6	7		
8	9	10	11	12
13	14	15	16	17
18	19	20	21	22
27	28			

When shooting with Live View

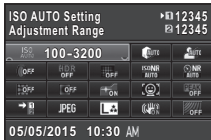

1	3	4		
2	3	4		
5	6	7		
8	9	10	11	12
13	14	15	16	17
18	19	20	21	22
27	28			

mode

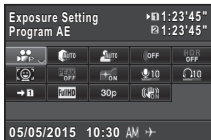

1	3	4		
2	3	4		
23	6	7	8	9
16	17	15	24	25
18	20	26	21	
27	28			

- 1 Function name
- 2 Setting
- 3 Card slot number
- 4 Number of recordable still pictures/Movie recordable time
- 5 ISO AUTO Setting (p.43)
- 6 Highlight Correction (p.60)
- 7 Shadow Correction (p.60)
- 8 Digital Filter (p.59)
- 9 HDR Capture (p.60)
- 10 Pixel Shift Resolution (p.61)
- 11 High-ISO NR (p.44)
- 12 Slow Shutter Speed NR (p.41)
- 13 Distortion Correction (p.61)
- 14 Peripheral Illumination Correction (p.61)
- 15 AF Assist Light (p.46)
- 16 AF Mode (p.46)/ Contrast AF (p.48)
- 17 Focusing area (AF point) (p.47)/Focus Peaking (p.48)
- 18 Memory Card Options (p.39)

- 19 File Format (p.39)
- 20 JPEG Recorded Pixels and Quality Level (p.39)/ Movie Recorded Pixels (p.39)
- 21 Shake Reduction/ Movie SR
- 22 AA Filter Simulator (p.62)
- 23 Exposure Setting (p.42)
- 24 Recording Sound Level (p.42)
- 25 Playback Sound Volume
- 26 Framerate (p.39)
- 27 Current date and time
- 28 Destination (p.82)

Memo

- The items that can be selected vary depending on the current camera setup.
- If no operations are made within 1 minute while the control panel is displayed, the camera returns to standby mode.
- You can change the display color of the status screen, control panel, and menu cursor in [Display Color] of [LCD Display] in the \blacktriangleright 1 menu. (p.25)

Shooting Info Display

You can change the type of information displayed in standby mode by pressing **INFO** while the control panel is displayed. Use **◀▶** to select the type and press **OK**.

When shooting with the viewfinder

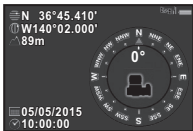
Status Screen	Displays the settings for shooting with the viewfinder. (p.10)
Electronic Level	Displays the camera angle. A bar scale indicating the horizontal camera angle appears at the bottom of the screen, and a bar scale indicating the vertical camera angle appears on the right side. When the angle exceeds the range that can be displayed in the scale, the indicators on the scale are displayed in red.  Example: Tilted 1.5° to the left (yellow) Vertically level (green)
Display Off	Nothing is displayed on the monitor.
Electronic Compass	Turns on the GPS function and displays the current latitude, longitude, altitude, lens direction, and Coordinated Universal Time (UTC). 

When shooting with Live View

Standard Information Display	The Live View image and the settings for shooting with Live View are displayed. (p.11)
No Information Display	Certain icons, such as those for the exposure mode and drive mode, are not displayed.

When the Camera is Held Vertically

When the camera is rotated to the vertical position, the status screen and control panel are displayed in a vertical position. To not display images in the vertical position, set [Auto Screen Rotation] to **□** (Off) in [LCD Display] of the **1** menu. (p.25)



Playback Mode

The captured image and shooting information are displayed in single image display of the playback mode.

Press **INFO** to change the type of information displayed in single image display. Use **◀▶** to select the type and press **OK**.



Single image display
(Standard Information
Display)



Playback Info Display
selection screen

Standard Information Display	Captured image, file format, exposure parameters, and operation guide indicators are displayed.
Detailed Information Display	Detailed information on how and when the image was taken is displayed. (p.15)
Histogram Display	Captured image and brightness histogram are displayed. (p.16) Not available during movie playback.
RGB Histogram Display	Captured image and RGB histogram are displayed. (p.16) Not available during movie playback.
No Information Display	Only the captured image is displayed.

Memo

- The screen selected in the Playback Info Display selection screen is displayed in playback mode when the camera is turned off and on again. If [Playback Info Display] is set to (Off) in [Memory] of the 4 menu, the [Standard Information Display] always appears first when the camera is turned on. (p.83)

Detailed Information Display

Still pictures

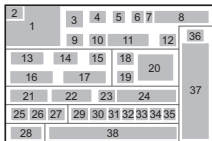

Movies

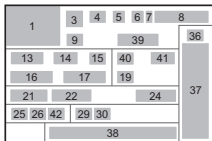
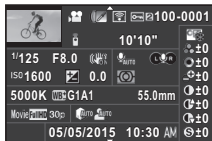

Page 2

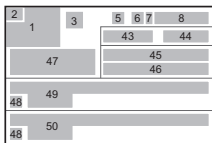
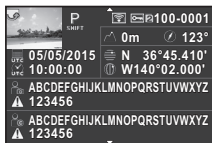

- 1 Captured image
- 2 Rotation information (p.70)
- 3 Exposure Mode (p.40)
- 4 Digital Filter (p.59)
- 5 Transferred via wireless LAN (p.86)
- 6 Protect setting (p.83)
- 7 Card slot number in use
- 8 Folder number-File number (p.84)
- 9 Drive Mode (p.50)
- 10 Flash Mode (p.45)
- 11 Flash Exposure Compensation (p.45)
- 12 Color Moiré Correction (p.73)
- 13 Shutter speed
- 14 Aperture value
- 15 Shake Reduction/ Horizon Correction/ Movie SR
- 16 Sensitivity (p.43)
- 17 EV Compensation (p.41)
- 18 Focus Method (p.46)
- 19 AE Metering (p.44)

- 20 Focusing area (AF point) (p.47)
- 21 White Balance (p.56)
- 22 White Balance fine-tuning (p.56)
- 23 HDR Capture (p.60)/ Pixel Shift Resolution (p.61)/AA Filter Simulator (p.62)
- 24 Lens focal length
- 25 File Format (p.39)
- 26 JPEG Recorded Pixels (p.39)/Movie Recorded Pixels (p.39)
- 27 JPEG Quality (p.39)
- 28 Color Space (p.28)
- 29 Highlight Correction (p.60)
- 30 Shadow Correction (p.60)
- 31 Distortion Correction (p.61)
- 32 Peripheral Illumination Correction (p.61)
- 33 Lateral Chromatic Aberration Adjustment (p.61)
- 34 Diffraction Correction (p.61)
- 35 Color Fringe Correction (p.77)
- 36 Custom Image setting (p.58)
- 37 Custom Image parameters
- 38 Shooting date and time
- 39 Length of time of the recorded movie
- 40 Recording Sound Level
- 41 Sound
- 42 Framerate (p.39)
- 43 Altitude
- 44 Lens direction
- 45 Latitude
- 46 Longitude
- 47 Universal Coordinated Time
- 48 Tamped image warning
- 49 Photographer (p.86)
- 50 Copyright Holder (p.86)

Histogram Display

Use ▲▼ to switch between the brightness histogram and RGB histogram.

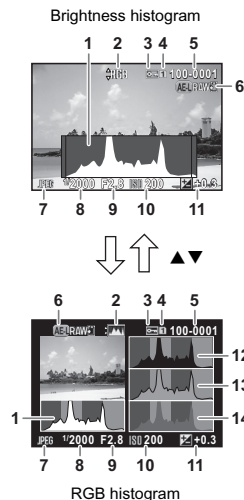

- 1 Histogram (Brightness)
- 2 Switch RGB histogram/
Brightness histogram
- 3 Protect setting
- 4 Card slot number in use
- 5 Folder number-File
number
- 6 Save RAW Data
- 7 File Format
- 8 Shutter speed
- 9 Aperture value
- 10 Sensitivity
- 11 EV Compensation
- 12 Histogram (R)
- 13 Histogram (G)
- 14 Histogram (B)

Viewfinder

When shooting with the viewfinder, the following information appears in the viewfinder.

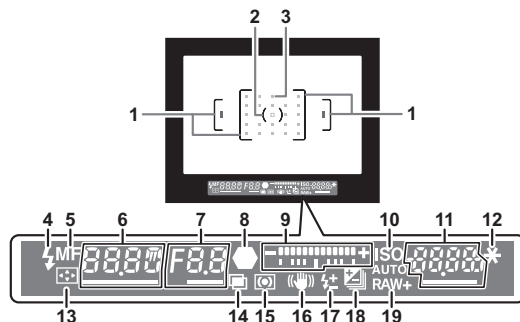

- | | |
|---|--|
| 1 AF frame (p.36) | 12 AE Lock |
| 2 Spot metering frame (p.44) | 13 Change AF Point (p.47) |
| 3 AF point (p.47) | 14 Multi-exposure (p.53) |
| 4 Flash indicator (p.45) | 15 AE Metering (p.44) |
| 5 Focus Method (p.46) | 16 Shake Reduction |
| 6 Shutter speed | 17 Flash Exposure Compensation (p.45) |
| 7 Aperture value | 18 EV Compensation (p.41)/Exposure Bracketing (p.52) |
| 8 Focus indicator | 19 File Format (p.39) |
| 9 EV bar scale/Electronic Level (p.17) | |
| 10 ISO/ISO AUTO | |
| 11 Sensitivity (p.43)/Exposure compensation value | |

Memo

- The information is displayed in the viewfinder when the shutter release button is pressed halfway, or during the meter operating time (default setting: 10 sec.).

- The AF point in use for autofocus appears in red (Superimpose AF Area) when the shutter release button is pressed halfway. You can set it to [Off] in [14. Superimpose AF Area] of the **C2** menu.
- You can adjust the viewfinder image sharpness using the diopter adjustment dial. Adjust the diopter setting until the AF frame in the viewfinder looks sharp and clear.

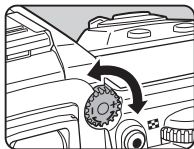

LCD Panel

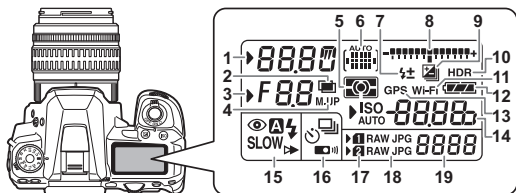

- | | |
|---|---|
| 1 Shutter speed | 11 Wireless LAN connection (p.86) |
| 2 Multi-exposure (p.53) | 12 Battery level |
| 3 Aperture value | 13 GPS turned on (p.63) |
| 4 Mirror Lock-up Shooting (p.53) | 14 Sensitivity (p.43)/EV Compensation (p.41) |
| 5 AE Metering (p.44) | 15 Flash Mode (p.45) |
| 6 Focusing area (AF point) (p.47) | 16 Drive Mode (p.50) |
| 7 Flash Exposure Compensation (p.45) | 17 Card slot number |
| 8 EV bar scale/Electronic Level (p.17) | 18 File Format (p.39) |
| 9 EV Compensation (p.41)/Exposure Bracketing (p.52) | 19 Remaining image storage capacity/USB connection mode (p.72)/Sensor cleaning in progress (p.94) |
| 10 HDR Capture (p.60) | |

Memo

- You can change the LCD panel backlight setting in [21. LCD Panel Illumination] of the **C3** menu. (p.28) You can also set the camera so that the LCD panel illumination turns on or off when **RAW** is pressed. (p.80)

Electronic Level

You can check whether the camera is tilted by displaying the electronic level. The electronic level for the horizontal camera angle can be displayed in the EV bar scale in the viewfinder and on the LCD panel, and the electronic levels for the vertical and horizontal camera angles can be displayed on the Live View screen. (p.11)

Select whether to display the electronic level in [Electronic Level] of the **C3** menu. (p.21)

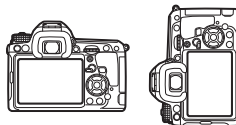

When level (at 0°)



When tilted 5° to the left



When held vertically and tilted 3° to the right



How to Change Function Settings

The camera functions and their settings can be selected and changed by using the following ways.

Direct keys	Press ▲▼◀▶ in standby mode.
Control panel	Press INFO in standby mode. (indicated with the  icon in this manual)
Menus	Press MENU .

Using the Direct Keys

▲	Drive Mode	p.50
▼	Flash Mode	p.45
◀	White Balance	p.56
▶	Custom Image	p.58

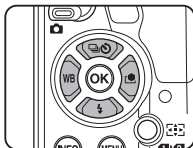

Using the Control Panel

INFO

You can set frequently used shooting functions. Press **INFO** in standby mode.

Use ▲▼◀▶ to select an item.

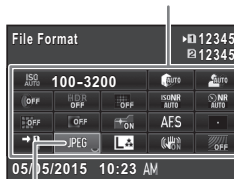

Use  to change settings.

Press **OK** to make detailed settings.

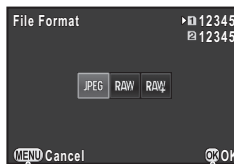

Press **MENU** to cancel the setting operation.

Press **OK** to confirm the selected item and return to the control panel.

Most functions are set from the menus. The functions that can be set on the control panel can also be set from the menus.

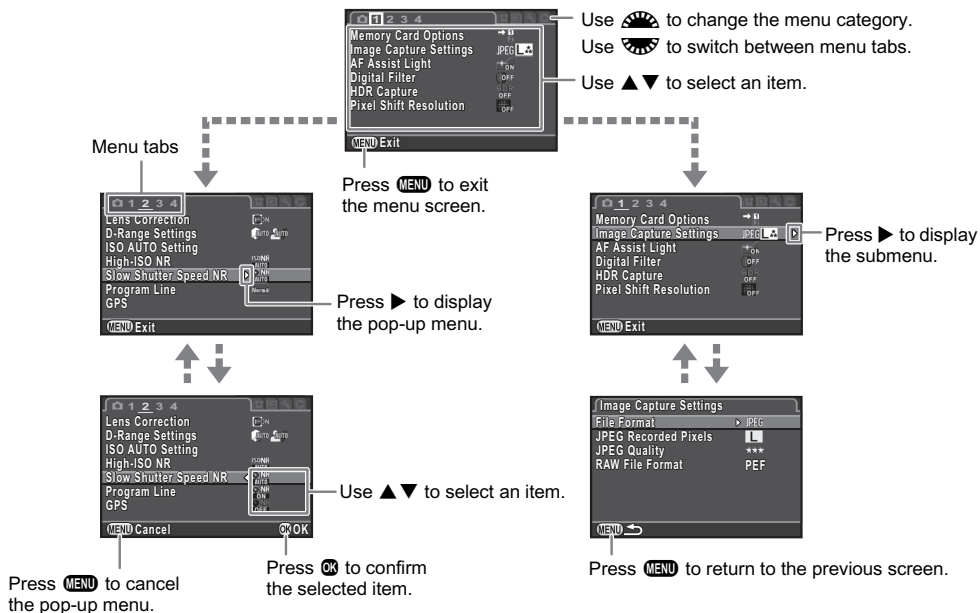

Memo

- For the Custom Setting menus (C1-4), you can show the setting screen of the next item in order of the menus on the monitor by turning while the submenu of the currently selected item is displayed.
- Press **MENU** to display the first tab of most appropriate menus for the camera settings at that time. To display the menu tab last selected first, set in [23. Save Menu Location] of the C4 menu.
- Settings are returned to their default values with [Reset] of the 3 menu. To reset all the settings in the Custom Setting menus to the defaults, use [Reset Custom Functions] of the C4 menu. (Some settings do not apply.)

Menu List











1





Introduction

Rec. Mode Menus

Menu	Item	Function	Default Setting	Page	
☑1	Exposure Mode *1	Temporarily changes the exposure mode when the mode dial is set to U1 , U2 , or U3 .	P	p.82	
	Memory Card Options *2	Sets the recording method for when two memory cards are inserted.	Sequential Use	p.39	
	Image Capture Settings	File Format *2	Sets the file format of images.	JPEG	p.39
		JPEG Recorded Pixels *2	Sets the recording size of JPEG images.	<input type="checkbox"/>	
		JPEG Quality *2	Sets the quality of JPEG images.	★★★	
		RAW File Format	Sets the RAW file format.	PEF	
	AF Assist Light *2	Discharges the assist light when autofocusing in dark locations.	On	p.46	
	Digital Filter *2	Applies a digital filter effect when taking pictures.	No Filter	p.59	
	HDR Capture	HDR Capture *2	Sets the type of high dynamic range shooting.	Off	p.60
		Exposure Bracket Value *2	Sets the amount to change the exposure.	±2EV	
Auto Align		Sets whether to automatically adjust the composition.	On		
Pixel Shift Resolution *2	Merges four images shifted by one pixel and outputs a high-definition image.	Off	p.61		
☑2	Lens Correction	Distortion Correction *2	Reduces distortions occurring due to lens properties.	Off	p.61
		Peripheral Illumin. Corr. *2	Reduces peripheral light fall-off occurring due to lens properties.	Off	
		Lat-Chromatic-Ab Adj	Reduces lateral chromatic aberrations occurring due to lens properties.	On	
		Diffraction Correction	Corrects blur caused by diffraction when using a small aperture.	On	
	D-Range Settings	Highlight Correction *2	Expands the dynamic range and prevents overexposed areas from occurring.	Auto	p.60
Shadow Correction *2		Expands the dynamic range and prevents underexposed areas from occurring.	Auto		
ISO AUTO Setting *2	Sets the range of automatic correction in ISO AUTO and the AUTO ISO Parameters.	ISO 100 to ISO 3200/Standard	p.43		

Menu	Item	Function	Default Setting	Page	
☑ ²	High-ISO NR ^{*2}	Sets the Noise Reduction setting when shooting with a high ISO sensitivity.	Auto	p.44	
	Slow Shutter Speed NR ^{*2}	Sets the Noise Reduction setting when shooting with a slow shutter speed.	Auto	p.41	
	Program Line	Selects the Program Line setting.	Normal	p.41	
	GPS	GPS Logging	Sets the logging interval and duration.	15sec./1hr./SD1	p.65
		ASTROTRACER	Sets whether to track and capture celestial bodies.	Off	p.66
Calibration		Performs a calibration.	-	p.64	
Additional Settings		Sets whether to enable the GPS time synchronization and GPS indicator lamp.	On/On	p.64	
☑ ³	Live View	Contrast AF ^{*2}	Sets the autofocus mode for shooting with Live View.	Face Detection	p.48
		Focus Peaking ^{*2}	Emphasizes the outline of the subject in focus and makes it easier to check the focus.	Off	p.48
		Grid Display	Displays the grid during Live View.	Off	p.11
		Histogram Display	Displays the histogram during Live View.	Off	
		Highlight Alert	Sets overexposed areas to blink red during Live View.	Off	
	Composition Adjust.	Allows you to adjust the composition of your image using the Shake Reduction mechanism.	Off	p.62	
	Electronic Level	Viewfinder	Displays the electronic level in the EV bar scale in the viewfinder and/or LCD panel.	Off	p.17
		Live View	Displays the electronic level during Live View.	On	p.11
	Horizon Correction	Corrects horizontal tilt when in  mode.	Off	-	
	AA Filter Simulator ^{*2}	Applies a low-pass filter effect using the Shake Reduction mechanism.	Off	p.62	
Shake Reduction ^{*2}	Activates the Shake Reduction function.	On	-		
Input Focal Length	Sets the focal length when using a lens of which focal length information cannot be obtained.	35mm	p.91		



Menu	Item	Function	Default Setting	Page	
<div style="text-align: center;">  4 </div>	Instant Review	Display Time	Sets the Instant Review display time.	1sec.	p.36
		Zoom Review	Displays the magnified image during Instant Review.	On	
		Save RAW Data	Saves the RAW data during Instant Review.	On	
		Delete	Deletes the displayed image during Instant Review.	On	
		Histogram Display	Displays the histogram during Instant Review.	Off	
		Highlight Alert	Sets overexposed areas to blink red during Instant Review.	Off	
	Digital Preview	Zoom Review	Displays a magnified image during Digital Preview.	On	p.50
		Save Preview Image	Saves the preview image as a new file.	On	
		Histogram Display	Displays the histogram during Digital Preview.	Off	
		Highlight Alert	Sets overexposed areas to blink red during Digital Preview.	Off	
	E-Dial Programming	P	Sets the  /  /  operation for each exposure mode.	Tv, Av, 	p.79
		Sv		-, ISO, -	
		Tv		Tv, -, -	
Av		-, Av, -			
TAv		Tv, Av, PLINE			
M		Tv, Av, PLINE			
B		-, Av, -			
X		-, Av, -			
		-, -, -			
		-, Av, PLINE			
		Tv, Av, PLINE			
		Tv, Av, PLINE			
Rotation Direction	Reverses the effect obtained when  or  is turned.	Rotate Right			

Menu	Item	Function	Default Setting	Page	
	Button Customization	RAW/Fx Button	Sets the function for when  is pressed.	One Push File Format	
		AF Button	Sets the function for when  is pressed.	Enable AF1	
		Preview Dial	Sets the camera action for when the main switch is turned to the  position.	Optical Preview	
	Memory		Determines which settings to save when the power is turned off.	On for settings other than Digital Filter, HDR Capture, and Pixel Shift Resolution	p.79 p.83
	Save USER Mode		You can save frequently used capture settings to U1 , U2 , or U3 of the mode dial.	–	p.81

*1 The function appears only when the mode dial is set to **U1**, **U2**, or **U3**.

*2 The function can also be set from the control panel.

Movie Menu





Menu	Item	Function	Default Setting	Page
	Exposure Setting *1	Sets the exposure mode for  mode.	Program AE	p.42
	Memory Card Options *1	Selects one of memory cards inserted in the SD1 and the SD2 slots for recording movies.	SD1	p.39
	Movie Capture Settings *1	Sets the number of recorded pixels and the framerate of the movie.	 /30p	p.39
	Recording Sound Level *1	Sets the Recording Sound Level for recording.	Auto	–
	Digital Filter *1	Applies a digital filter effect when recording a movie.	No Filter	p.59
	HDR Capture *1	Sets the type of high dynamic range shooting.	Off	p.60
	Movie SR *1	Activates the Shake Reduction function.	On	–

*1 The function can also be set from the control panel.

Menu	Item	Function	Default Setting	Page	
▶ 1	Slideshow	Display Duration	Sets an image display interval.	3sec.	p.69
		Screen Effect	Sets a transition effect when the next image is displayed.	Off	
		Repeat Playback	Starts the slideshow again from the beginning after the last image is displayed.	Off	
		Auto Movie Playback	Plays back movies during the slideshow.	On	
	Quick Zoom	Sets the initial magnification when magnifying images.	Off	p.38	
▶ 1	Highlight Alert	Sets overexposed areas to blink red in Standard Information Display or Histogram Display of the playback mode.	Off	-	
	Auto Image Rotation	Rotates images which were captured with the camera held vertically or of which the rotation information has been changed.	On	p.70	
	Protect All Images	Protects all stored images at once.	-	p.83	
	Delete All Images	Deletes all stored images at once.	-	-	

Set-up Menus

Menu	Item	Function	Default Setting	Page	
1	Language/言語	Changes the display language.	English	p.33	
	Date Adjustment	Sets the date and time and the display format.	01/01/2015	p.34	
	World Time	Switches between the date and time display of your hometown city and that of a specified city.	Hometown	p.82	
	Text Size	Magnifies the text size when selecting a menu item.	Standard	p.34	
	Sound Effects	Switches the operation sound on/off and changes the volume for In-focus, AE-L button operation, Self-timer, Remote Control, Mirror Up, Change AF Point, RAW button operation, and GPS button operation.	Volume 3/ All On	-	
	LCD Display	Guide Display	Displays the operation guides when the exposure mode is changed.	On	p.36
		Auto Screen Rotation	Displays the status screen and control panel vertically if the camera is held vertically.	On	p.13
		Display Color	Sets the display color of the status screen, control panel, and menu cursor.	1	p.12
	LCD Display Settings		Adjusts the brightness, saturation and the color of the monitor.	0	-
2	USB Connection	Sets the USB connection mode when connecting to a computer.	MSC	p.72	
	HDMI Out	Sets the output format when connecting to an AV device with an HDMI input terminal.	Auto	p.71	
	Folder Name	Sets the folder name in which images are stored.	Date	p.84	
	Create New Folder	Creates a new folder on the memory card.	-	p.85	
	File Name	Sets the file name assigned to an image.	IMGP/_IMG	p.85	
	File No.	Sequential Numbering	Continues the sequential numbering for the file name when a new folder is created.	On	p.86
		Reset File Number	Resets the file number setting and returns to 0001 each time a new folder is created.	-	
	Copyright Information		Sets the photographer and copyright information embedded in the Exif data.	Off	p.86

Menu	Item	Function	Default Setting	Page
3	Flicker Reduction	Cuts down on monitor flicker by setting the power frequency.	50Hz	–
	Auto Power Off	Sets the time until the camera turns off automatically if no operations are made for a certain period of time.	1min.	p.33
	Select Battery	Sets the camera action for when the optional battery grip is attached to the camera.	Auto Select/ Auto-detect	p.31
	Wireless Memory Card	Sets the camera action for when an Eye-Fi card or a Flucard is used.	–	p.86
	Reset	Resets the settings of the direct keys and for the items of the  menu,  menu,  menu,  menu, control panel, and playback mode palette.	–	–
4	Pixel Mapping	Maps out and corrects any defective pixels on the sensor.	–	p.93
	Dust Alert	Detects dust adhering to the sensor and visually displays the location of the dust on the monitor.	–	p.93
	Dust Removal	Cleans the sensor by applying high-frequency (ultrasonic) vibrations.	–	p.93
	Sensor Cleaning	Locks the mirror in the up position for cleaning the sensor with a blower.	–	p.94
	Format	Formats a memory card.	–	p.35
	Firmware Info/Options	Displays the camera's firmware version. You can check the current firmware version before running an update.	–	–

Custom Setting Menus

Menu	Item	Function	Default Setting	Page
C1	1. EV Steps	Sets the adjustment steps for exposure.	1/3 EV Steps	p.41
	2. Sensitivity Steps	Sets the adjustment steps for ISO sensitivity.	1 EV Step	p.43
	3. Meter Operating Time	Sets the meter operating time.	10sec.	–
	4. AE-L with AF Locked	Sets whether to lock the exposure value when the focus is locked.	Off	–
	5. Link AE and AF Point	Sets whether to link the exposure value and AF point in the focusing area.	Off	–
	6. Auto EV Compensation	Automatically compensates the exposure when the correct exposure cannot be achieved with the current settings.	Off	–
	7. Bulb (B) Mode Options	Sets the camera operation when pressing the shutter release button in B mode.	Type1	–
C2	8. Bracketing Order	Sets the order for Exposure Bracketing shooting.	0 - +	p.53
	9. One-Push Bracketing	Shoots all frames with one release when using Exposure Bracketing.	Off	p.53
	10. WB Adjustable Range	Sets whether to automatically fine-tune the white balance when the light source is specified for the white balance setting.	Fixed	p.56
	11. WB When Using Flash	Sets the white balance setting when using a flash.	Auto White Balance	p.56
	12. AWB in Tungsten Light	Sets the tungsten light color tone when the white balance is set to [Auto White Balance].	Strong Correction	p.56
	13. Color Temperature Steps	Sets the adjustment steps for the Color Temperature option of the white balance.	Kelvin	p.57
	14. Superimpose AF Area	Displays the active AF point in red in the viewfinder.	On	p.17
C3	15. AF.S Setting	Sets the action priority for when the autofocus mode is set to AF.S and the shutter release button is fully pressed.	Focus-priority	p.47
	16. 1st Frame Action in AF.C	Sets the action priority for the first frame when the autofocus mode is set to AF.C and the shutter release button is fully pressed.	Release-priority	p.47
	17. Action in AF.C Continuous	Sets the action priority during Continuous Shooting when the autofocus mode is set to AF.C .	Focus-priority	p.47

Menu	Item	Function	Default Setting	Page
C3	18. Hold AF Status	Maintains the focus for a certain amount of time when the subject happens to move out of the selected focusing area after being focused.	Off	p.47
	19. AF with Remote Control	Sets whether to use autofocus when shooting with a remote control unit.	Off	p.52
	20. Color Space	Sets the color space to use.	sRGB	–
	21. LCD Panel Illumination	Sets the illumination for the LCD panel.	High	p.17
C4	22. Save Rotation Info	Saves rotation information when shooting.	On	p.70
	23. Save Menu Location	Saves the last menu tab displayed on the monitor and displays it again the next time MENU is pressed.	Reset Menu Location	p.19
	24. Catch-In Focus	Enables Catch-in Focus shooting when a manual focus lens is attached. The shutter is released automatically when the subject comes into focus.	Off	–
	25. AF Fine Adjustment	Allows you to precisely fine tune your lenses with the camera's autofocus system.	Off	p.49
	26. Using Aperture Ring	Enables the shutter to release when the lens aperture ring is set to a position other than A (Auto).	Disable	p.90
	Reset Custom Functions	Resets all the settings of the Custom Setting menus to the defaults.	–	–

Attaching the Strap

- 1 Pass the end of the strap through the protective cover and triangular ring.

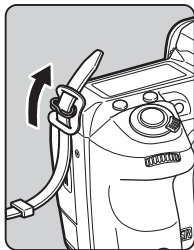

- 2 Secure the end of the strap on the inside of the clasp.

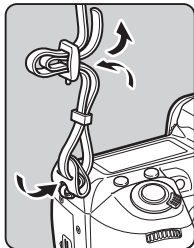

Attaching a Lens

- 1 Make sure that the camera is turned off.

- 2 Remove the body mount cover (1) and lens mount cover (2).

After removing the cover, be sure to put the lens down with the lens mount side facing upward.

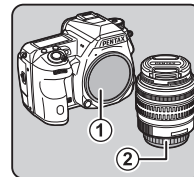

- 3 Align the lens mount indexes (red dots: 3) on the camera and the lens, and secure by turning the lens clockwise until it clicks.

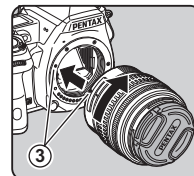

To remove the lens

Attach the lens cap, and then turn the lens counterclockwise while pressing the lens unlock button (4).

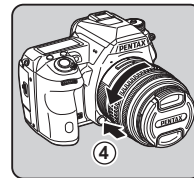

⚠ Caution

- When attaching or removing the lens, choose an environment that is relatively free of dirt and dust.
- Keep the body mount cover attached on the camera when a lens is not attached.
- Be sure to attach the lens mount cover and lens cap to the lens after removing it from the camera.
- Do not insert your fingers inside the lens mount of the camera or touch the mirror.
- The camera body and lens mount incorporate lens information contacts. Dirt, dust, or corrosion may damage the electrical system. Please contact your nearest service center for professional cleaning.
- When a retractable lens is attached and is not extended, you cannot take pictures or use some functions. If the lens is retracted during shooting, the camera stops working. Refer to "How to Use a Retractable Lens" (p.37) for details.
- We assume no responsibility nor liability for accidents, damages and malfunctions resulting from the use of lenses made by other manufacturers.

📄 Memo

- Refer to "Functions Available with Various Lenses" (p.89) for details on the functions of each lens.

Using the Battery and Charger

Use the battery D-LI90 and battery charger D-BC90 exclusively developed for this camera.

Note (for USA only): AC plug cord
UL Listed, Type SPT-2 or NISPT-2, 18/2 flexible cord,
rated 125 V, 7 A, minimum 6 ft. (1.8 m)

Charging the Battery

1 Connect the AC plug cord to the battery charger.

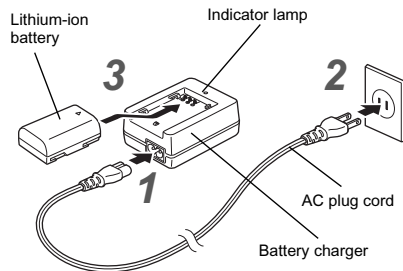

2 Plug the AC plug cord into the power outlet.

3 Face the ▲ mark on the battery up, and insert it into the battery charger.

The indicator lamp is lit while charging and turns off when the battery is fully charged.

⚠ Caution

- Do not use the battery charger D-BC90 to charge batteries other than the battery D-LI90. Charging other batteries may cause damage or heating.
- Replace the battery with a new one in the following cases:
 - If the indicator lamp blinks or does not light after the battery is inserted correctly
 - If the battery starts to run down more quickly even after being charged (the battery may have reached the end of its service life)

Memo

- The maximum charging time is approximately 390 minutes (it depends on temperature and remaining battery power). Charge in a location where the temperature is between 0°C and 40°C (32°F and 104°F).

Inserting/Removing the Battery

Caution

- Insert the battery correctly. If the battery is inserted incorrectly, it may not be removed.
- Wipe the electrodes of the battery with a soft dry cloth before inserting.
- Do not open the battery cover or remove the battery while the power is on.
- Be careful as the camera or battery may become hot after the camera has been used continuously for a long period of time.
- Remove the battery when you will not use the camera for a long time. The battery may leak and damage the camera if left installed during prolonged periods of non-use. If the removed battery will not be used for six months or longer, charge the battery for about 30 minutes before storing it. Be sure to recharge the battery every six to twelve months.
- Store the battery in a location where the temperature will remain at or below room temperature. Avoid locations with high temperatures.
- The date and time may be reset if you leave the battery out of the camera for long periods of time. If this happens, set the current date and time again.

1 Open the battery cover.

Lift the battery cover unlock knob, turn it towards OPEN to unlock, and then pull the cover open.



2 Face the ▲ mark on the battery towards the outside of the camera, and insert the battery until it locks into place.

To remove the battery, push the battery lock lever in the direction of ③.

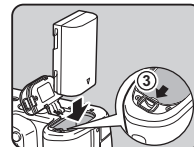

3 Close the battery cover.

Turn the battery cover unlock knob towards CLOSE to lock, and fold the knob.

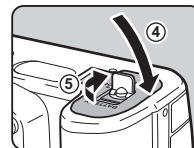

Memo

- The battery level may not be displayed properly if the camera is used at low temperatures or when performing Continuous Shooting for a long time.
- Battery performance temporarily decreases as the temperature decreases. When using the camera in cold climates, have extra batteries at hand and keep them warm in your pocket. Battery performance will return to normal at room temperature.
- Have extra batteries ready when traveling overseas or taking a lot of pictures.
- When the optional Battery Grip D-BG5 is used, the following settings can be made in [Select Battery] of the  3 menu.
 - Priority order of battery use
 - Type of AA batteries used

Using the AC Adapter

We recommend the use of the optional AC adapter kit K-AC132 when using the monitor for a long time or when connecting the camera to a computer or AV device.

- 1 **Make sure that the camera is turned off, and open the terminal cover.**

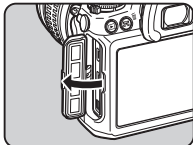

- 2 **Align the ▲ marks on the DC terminal of the AC adapter and DC input terminal of the camera, and connect.**

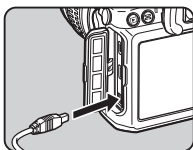

- 3 **Connect the AC adapter to the AC plug cord, and plug the cord into the power outlet.**

⚠ Caution

- Make sure that the camera is turned off before connecting or disconnecting the AC adapter.
- Make sure that connections are secure between the terminals. The memory card or data may be corrupted if the connection to the power supply is lost while the card is being accessed.
- Be sure to read the manual of the AC adapter kit before using the AC adapter.

Inserting a Memory Card

The following memory cards can be used with this camera.

- SD Memory Card, SDHC Memory Card, and SDXC Memory Card
- Eye-Fi card
- Flucard compatible with this camera

In this manual, these cards are referred to as memory cards.

- 1 **Make sure that the camera is turned off.**
- 2 **Slide the memory card cover in the direction of ① and then rotate it to open as shown by ②.**

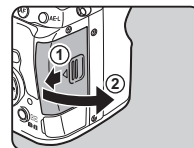

- 3 **Insert the card all the way into the memory card slot with the memory card label facing toward the side with the monitor.**

To use an Eye-Fi card or a Flucard, insert the card in the SD2 slot.

Push the memory card in once and release to remove.

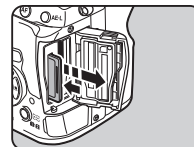
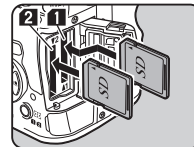

- 4** Rotate the memory card cover as shown by ③, and slide it in the direction of ④.

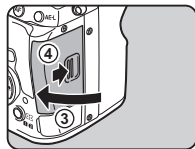

⚠ Caution

- Do not remove the memory card while the card access lamp is lit.
- If the memory card cover is opened while the power is on, the camera turns off. Do not open the cover while the camera is in use.
- Use this camera to format (initialize) a memory card that is unused or has been previously used on other devices. (p.35)
- Use a high-speed memory card when recording movies. If the write speed cannot keep up with the recording speed, writing may stop during recording.

📝 Memo

- For details on how the data is recorded when two memory cards are inserted, refer to "Memory Card Settings" (p.39).
- When using an Eye-Fi card or a Flucard, refer to "Using a Wireless Memory Card" (p.86).

Initial Settings

Turn the camera on and make the initial settings.

Turning the Camera On

- 1** Turn the main switch to [ON].

The first time the camera is turned on after purchase, the [Language/言語] screen appears.

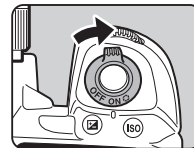

📝 Memo

- The power automatically turns off when you do not perform any operations within a set period of time. (Default setting: 1min.) You can change the setting in [Auto Power Off] of the 3 menu.

Setting the Display Language

- 1** Use ▲▼◀▶ to select the desired language and press **OK**.

The [Initial Setting] screen appears in the selected language. Proceed to Step 6 if **🏠** (Hometown) does not need to be changed.

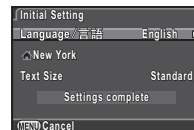

- 2** Press ▼ to move the frame to **🏠** and press ▶.

The [**🏠** Hometown] screen appears.

- 3** Use ◀▶ to select a city.

Use **🌐** to change the region. Refer to "List of World Time Cities" (p.100) for cities that can be selected as a hometown.

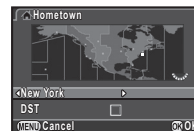

4 Press **▼** to select **[DST]** (daylight saving time), and use **◀▶** to select or .

5 Press **OK**.

The camera returns to the [Initial Setting] screen.

6 Press **▼** to select **[Text Size]** and press **▶**.

7 Use **▲▼** to select **[Standard]** or **[Large]**, and press **OK**.

Selecting [Large] increases the text size of the selected menu items.



8 Press **▼** to select **[Settings complete]** and press **OK**.

The [Date Adjustment] screen appears.



Setting the Date and Time

1 Press **▶**, and use **▲▼** to select the date format.

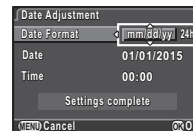

2 Press **▶**, and use **▲▼** to select **[24h]** or **[12h]**.

3 Press **OK**.

The frame returns to [Date Format].

4 Press **▼**, and then press **▶**.

The frame moves to the month if the date format is set to [mm/dd/yy].

5 Use **▲▼** to set the month.

Set the day, year and time in the same manner.

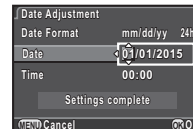

6 Press **▼** to select **[Settings complete]** and press **OK**.

The camera switches to capture mode and is ready to take a picture.

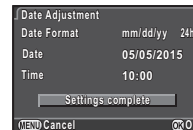

Memo

- You can change the language, text size, and date and time settings from the **1** menu. (p.25)
- The date and time settings can be automatically adjusted using information obtained from GPS satellites. (p.63)

- 1 Press **MENU**.
The 1 menu appears.
- 2 Use or to display 4 menu.
- 3 Use to select **[Format]** and press .
The **[Format]** screen appears.
- 4 Use to select the memory card slot in which the memory card to format is inserted and press .

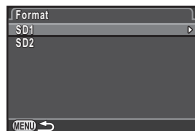

- 5 Press to select **[Format]** and press **OK**.
Formatting starts. When formatting is completed, the screen of Step 4 reappears.

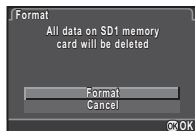

- 6 Press **MENU** twice.

⚠ Caution

- Do not remove the memory card while formatting, or the card may be damaged.
- Formatting deletes all data, both protected and unprotected.

📝 Memo

- When a memory card is formatted, the volume label "K-3 II" is assigned to the card. When the camera is connected to a computer, the memory card is recognized as a removable disk with the name "K-3 II".

Take pictures in (Green) mode in which the camera automatically sets the optimal exposure.

Shooting with the Viewfinder

- 1 Remove the front lens cap by pushing the top and bottom portions as indicated in the illustration.

When a retractable lens is attached, extend the lens before turning the camera on.

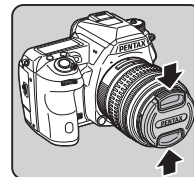

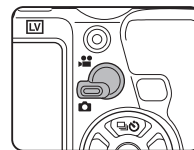

How to Use a Retractable Lens (p.37)

- 2 Turn the camera on.
- 3 Turn the capture mode selector switch to .

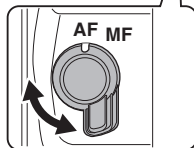
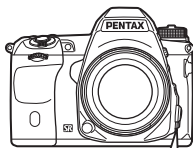

- 4** Set the focus mode switch to AF.



- 5** Set the mode dial to  while pressing the mode dial lock button.

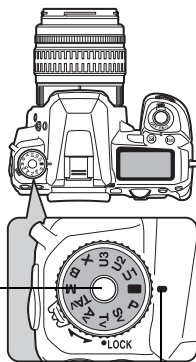

Mode dial lock button

Dial indicator

The selected exposure mode is displayed on the monitor (Guide Display).

-  Guide Display settings (p.25)



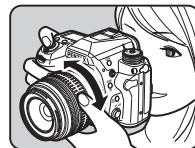

- 6** Look through the viewfinder to view the subject.

When using a zoom lens, turn the zoom ring to the right or left to change the angle of view.



- 7** Position the subject inside the AF frame and press the shutter release button halfway.

The focus indicator () appears and you will hear a beep when the subject comes into focus.

-  Setting the Sound Effects (p.25)





Focus indicator

- 8** Press the shutter release button fully.

The captured image is displayed on the monitor (Instant Review).

Available operations during Instant Review

- | | |
|---|---|
|  | Deletes the image. |
|  | Magnifies the image. |
|  | Saves the RAW data (only when a JPEG image was taken and the data remains in the buffer). |

Shooting with Live View

1 Press **LV** in Step 6 on "Shooting with the Viewfinder" (p.36).

The Live View image is displayed on the monitor.

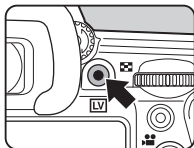

2 Position the subject inside the AF frame on the monitor and press the shutter release button halfway.

The AF frame turns green and you will hear a beep when the subject comes into focus.



AF frame

Available operations during Live View

- Magnifies the image.**
Use to change the magnification (up to 10×).
Use to change the area to display.
Press to return the display area to the center.
Press to return to 1× image display.

LV Exits shooting with Live View.

Subsequent steps are the same as shooting with the viewfinder.

Memo

- You can use **AF** to focus on the subject. (p.46)
- You can preview the image on the monitor and check the depth of field before shooting. (p.49)
- You can set the operation and display settings for Instant Review in [Instant Review] of the 4 menu. (p.22)
When [Display Time] is set to **HOLD**, Instant Review is displayed until the next operation.

Caution

- Some functions are not available in mode. If you attempt to use the functions that are not available, such as the direct key operation, the message [This function is not available in the current mode] appears.

Easy Operation of the Mode Dial

Release the mode dial lock using the mode dial lock release lever to easily operate the mode dial without having to press the mode dial lock button.

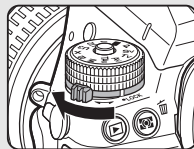

How to Use a Retractable Lens

If the camera is turned on when a retractable lens, such as HD PENTAX-DA 18-50mm F4-5.6 DC WR RE, is attached and is not extended, an error message is displayed on the monitor. Turn the zoom ring in the direction of **②** while pressing the button on the ring **①** to extend the lens. When retracting the lens, turn the zoom ring in the opposite direction to **②** while pressing the button on the ring and align the white dot to the position **③**.

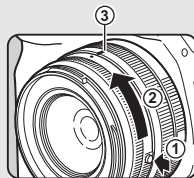

Reviewing Images

Review the captured image on the monitor.

1 Press .

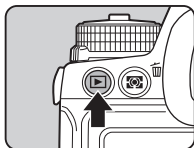











The camera enters playback mode and the most recently captured image is displayed (single image display).



2 Review the captured image.

Available operations

 to the left	Displays the previous image.
 to the right	Displays the next image.
	Deletes the image.
 to the right	Magnifies the image (up to 16×). Use    to change the area to display. Press  to return the display area to the center. Press  to return to the entire image display.
 to the left	Switches to the thumbnail display (p.68).
	Switches between the SD1 card and the SD2 card.



Saves the RAW data (only when a JPEG image was taken and the data remains in the buffer).







Changes the type of information displayed (p.14).



Displays the playback mode palette (p.67).

Memo

- When  is turned to the right to magnify the image, the magnification is displayed at the bottom right of the screen.  appears when the image is displayed at the actual pixel size (1× image display). You can set the initial magnification when magnifying images in [Quick Zoom] of the  1 menu.
- When  is displayed on the monitor, the JPEG image that was just taken can also be saved in RAW format (Save RAW Data).

Configuring the Capture Settings

Memory Card Settings



Set the recording method for when two memory cards are inserted in [Memory Card Options] of the 1 menu or the control panel.

	Sequential Use	When the memory card in the SD1 slot becomes full, data is saved to the card in the SD2 slot.
	Save to Both	Saves the same data to the memory cards in both the SD1 and the SD2 slots.
	Separate RAW/JPEG	Saves the RAW data to the memory card in the SD1 slot, and the JPEG data to the card in the SD2 slot.

Memo

- When in mode, data is saved to the card in either the SD1 or the SD2 slot. Set in [Memory Card Options] of the 1 menu.

Image Capture Settings



Set the file format for still pictures in [Image Capture Settings] of the 1 menu or the control panel.

File Format	JPEG, RAW, RAW+
JPEG Recorded Pixels	
JPEG Quality	★★★, ★★, ★
RAW File Format	PEF, DNG

Caution

- When [Memory Card Options] is set to [Separate RAW/JPEG], [File Format] is fixed to [RAW+].

Memo

- When [File Format] is set to [RAW+], a JPEG image and a RAW image with the same file number are saved at the same time.
- You can take pictures with a different file format setting only when is pressed. (p.80)
- [PEF] of [RAW File Format] is a PENTAX original RAW file format.

Movie Capture Settings



Set the file format for movies in [Movie Capture Settings] of the 1 menu or the control panel.

Recorded Pixels	Framerate
	60i, 50i, 30p, 25p, 24p
	60p, 50p, 30p, 25p, 24p

Taking Still Pictures

Select the exposure mode that suits the subject and shooting conditions.



The following exposure modes are available on this camera.

✓: Available #: Restricted X: Not available

Mode	Change Shutter Speed	Change Aperture Value	Change Sensitivity	EV Compensation
P Program Automatic Exposure	# *1	# *1	✓	✓
Sv Sensitivity Priority Automatic Exposure	X	X	✓ *2	✓
Tv Shutter Priority Automatic Exposure	✓	X	✓	✓
Av Aperture Priority Automatic Exposure	X	✓	✓	✓
TAv Shutter & Aperture Priority Automatic Exposure	✓	✓	✓ *3	✓
M Manual Exposure	✓	✓	✓ *2	✓
B Bulb Exposure	X	✓	✓ *2	X
X Flash X-sync Speed	X *4	✓	✓ *2	✓

- *1 You can set the value to be changed in [E-Dial Programming] of the  menu. (p.79)
- *2 [ISO AUTO] is not available.
- *3 Fixed to [ISO AUTO].
- *4 Fixed to 1/180 seconds.

1 Set the mode dial to the desired exposure mode.

 or  appears on the status screen for the value that can be changed.



The value that can be changed is underlined in the viewfinder.

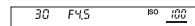

▶ appears on the LCD panel for the value that can be changed.

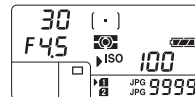

During Live View, ▶ appears for the value that can be changed.



2 Turn .

The aperture value is changed in **Av**, **TAv**, **M**, **B**, or **X** mode. The sensitivity is changed in **Sv** mode.

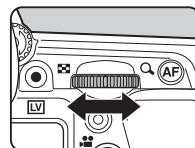

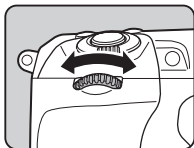

3 Turn .

The shutter speed is changed in **Tv**, **TAv**, or **M** mode.









Memo

- The settings for exposure can be specified in increments of 1/3 EV steps. In [1. EV Steps] of the **C1** menu, you can change the adjustment steps to 1/2 EV steps.
- The correct exposure may not be obtained with the selected shutter speed and aperture value when the sensitivity is fixed to a certain sensitivity.
- In **M** or **X** mode, the difference from the correct exposure is displayed on the EV bar scale while exposure is adjusted.
- In **B** mode, the drive mode cannot be set to [Continuous Shooting], [Exposure Bracketing], [Multi-exposure+Continuous], [Interval Shooting], or [Interval Composite].
- For each exposure mode, you can set the camera operation for when  or  is turned or  is pressed. Set in [E-Dial Programming] of the **C4** menu. (p.79)
- When shooting with a low shutter speed, you can reduce image noise in [Slow Shutter Speed NR] of the **C2** menu or the control panel.

AUTO	Applies Noise Reduction according to the shutter speed, sensitivity, and internal temperature of the camera.
ON	Applies Noise Reduction when the shutter speed is slower than 1 second.
OFF	Does not apply Noise Reduction at any shutter speed.

Program Line

In [Program Line] of the **C2** menu, you can specify how exposure is controlled when [**P**LINE] is selected for the  button operation.

 Auto	Determines the appropriate settings.
 Normal	Basic Program Automatic Exposure
 Hi-speed priority	Prioritizes high shutter speeds.
 DOF priority (deep)	Closes the aperture for a deep depth of field.
 DOF priority (shallow)	Opens the aperture for a shallow depth of field.
 MTF priority	Sets the sharpest aperture of the attached lens when a DA, DA L, D FA, FA J, or FA lens is used.

EV Compensation



The compensation value can be set between -5 and +5 EV (-2 and +2 EV in  mode).

1 Press , and then turn .

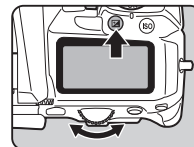
 and the compensation value are displayed on the status screen, Live View screen, LCD panel and in the viewfinder during adjustment.



Available operations

-  Starts/ends adjusting the compensation value.
-  Resets the adjustment value to the default setting.

Memo

- Exposure Bracketing shooting enables you to take pictures while automatically changing exposure. (p.52)

Recording Movies

1 Turn the capture mode selector switch to .

Live View is displayed.



Recordable Time

2 Focus on the subject.

In **AF** mode, press the shutter release button halfway.

3 Press .

Movie recording starts.

In the upper left area of the monitor, "REC" blinks and the size of the recorded movie file is displayed.

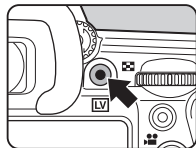





4 Press again.

Movie recording stops.

Caution

- When recording a movie with sound, the camera operation sounds are also recorded.
- When recording a movie with an image processing function such as Digital Filter applied, the movie file may be saved with some frames omitted.
- If the internal temperature of the camera becomes high during recording, recording may be terminated.
- When a retractable lens is attached, recording stops if the lens is retracted during recording and an error message is displayed.

Memo

- Recording can be started or stopped by pressing the shutter release button fully.
- You can change the movie settings in the  1 menu or from the control panel. (p.23) When [Exposure Setting] is set to , , or , you can set exposure before shooting.
- When [Recording Sound Level] is set to [Manual], a bar graph indicating the microphone volume level appears on the left edge (both edges when a stereo microphone is connected) of the monitor.
- You can record a movie continuously up to 4 GB or 25 minutes. When the memory card is full, recording stops.

Using a Microphone or Headphones

Microphone terminal

You can record stereo sound by connecting a commercially available stereo microphone to the microphone terminal on the camera. Using an external microphone can also help to reduce the possibility of recording camera operation sounds.

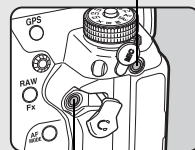

Headphone terminal

The following specifications are recommended for external microphones.

Plug	Stereo mini plug (ø 3.5 mm)
Format	Stereo electret condenser
Power	Plug-in Power Method (operating voltage of 2.0 V or lower)
Impedance	2.2 kΩ

If the external microphone is disconnected during recording, no sound is recorded.

You can record and play back movies while listening to the sound by connecting commercially available headphones to the headphone terminal.

Playing Back Movies

- 1 Display the movie to play back in single image display of the playback mode.



Available operations

	Plays back/pauses a movie.
	Forwards a frame (when paused).
Press and hold	Fast-forwards playback.
	Reverses a frame (when paused).
Press and hold	Fast-reverses playback.
	Stops playback.
	Adjusts the sound volume (21 levels).
	Saves the displayed frame as a JPEG file (when paused).
	Switches between [Standard Information Display] and [No Information Display].

Memo

- In [Movie Edit] of the playback mode palette, a movie file can be divided into multiple segments or selected frames can be deleted. (p.76)

Setting the Exposure

Sensitivity

- 1 Press , and then turn .

The sensitivity displayed on the status screen, Live View screen, LCD panel and in the viewfinder changes.

Press to set the sensitivity to [ISO AUTO].

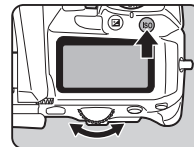

Memo

- When [Exposure Setting] is set to in mode, the sensitivity can be set from ISO 100 to ISO 3200.
- The adjustment steps for ISO sensitivity is 1 EV step. To adjust the sensitivity in accordance with the EV step setting for exposure, set from [2. Sensitivity Steps] of the menu.

Setting the Range of ISO AUTO



You can set the range in which the sensitivity is automatically adjusted when the sensitivity is set to ISO AUTO. Set in [ISO AUTO Setting] of the menu or the control panel. (Default setting: ISO 100 to ISO 3200)

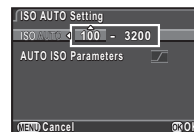

The manner in which the sensitivity is increased can be specified in [AUTO ISO Parameters].

	Increases the sensitivity as little as possible.
<input checked="" type="checkbox"/>	Increases the sensitivity at the intermediate level between and .
	Actively increases the sensitivity.

⚠ Caution

- When [HDR Capture] of the 1 menu is enabled and [Auto Align] is set to (On), [AUTO ISO Parameters] is fixed to .

Noise Reduction when Shooting with a High ISO Sensitivity



You can set the Noise Reduction setting when shooting with a high ISO sensitivity in [High-ISO NR] of the 2 menu or the control panel.

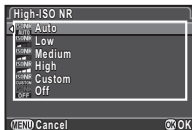

Auto	Applies Noise Reduction at optimally calculated levels throughout ISO range.
Low/ Medium/ High	Applies Noise Reduction at constant chosen level throughout ISO range.
Custom	Applies Noise Reduction at user-defined levels for each ISO setting.
Off	Does not apply Noise Reduction at any ISO setting.

When [Custom] is selected, select [Setting] and set the noise reduction level according to the ISO sensitivity.

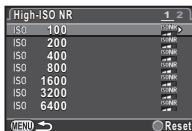

AE Metering

Choose the part of the sensor to use for measuring brightness and determining exposure.

- 1 Turn while pressing .

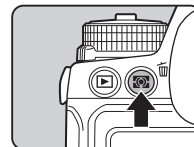

Multi-segment	Meters the brightness in multiple different zones of the sensor. In backlit conditions, this mode automatically adjusts exposure.
Center-weighted	Meters the brightness with an emphasis on the center of the sensor. The sensitivity increases at the center and no automatic adjustment is performed even in backlit conditions.
Spot	Meters the brightness only within a limited area at the center of the sensor. Useful when the subject is small.

Using a Flash

When an external flash (optional) is connected to the camera, you can discharge a flash for shooting.

Connecting a Flash

Remove the hot shoe cover from the camera, and attach an external flash.

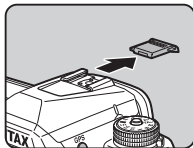

Memo

- Refer to "Functions when Using an External Flash" (p.91) for details on the function of external flashes.

Setting the Flash Mode

1 Press **▼** in standby mode.

2 Select a flash mode.



	Auto Flash Discharge	Automatically measures the ambient light and determines whether to use the flash.
	Auto Flash + Red-eye Reduction	Discharges a pre-flash for red-eye reduction before an automatic flash.
	Flash On	Discharges a flash for each picture.

	Flash On + Red-eye Reduction	Discharges a pre-flash for red-eye reduction before the main flash for each picture.
	Slow-speed Sync	Sets to a slow shutter speed and discharges a flash for each picture. Use this, for example, when shooting a portrait with the sunset in the background.
	Slow-speed Sync + Red-eye	Discharges a pre-flash for red-eye reduction before the main flash is discharged with Slow-speed Sync.

3 To compensate the flash output, press **▼** and then use to adjust the value. Press **○** to reset the value to 0.0.



4 Press **OK**.

The camera returns to standby mode.

Memo

- The flash modes that can be selected vary depending on the exposure mode.

Exposure Mode	Selectable Flash Mode
	* No flash compensation
P, Sv, Av	
Tv, TvAv, M, B, X	

- When the flash is used in **Av** mode, the shutter speed automatically changes over a range from 1/180 seconds to a slow shutter speed depending on the lens being used. The shutter speed is locked at 1/180 seconds when a lens other than a DA, DA L, D FA, FA J, FA, or F lens is used.
- When the flash is used in **Tv**, **TvAv**, or **M** mode, any desired shutter speed of 1/180 seconds or slower can be set.

Setting the Focus Method

Set the focus mode switch to **AF** or **MF**.

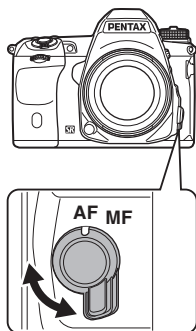

The autofocus method for shooting with the viewfinder differs from that for shooting with Live View.

Shooting with the viewfinder	<p>TTL phase-matching autofocus: Select from A.F.S., A.F.C., or A.F.A mode which enables automatically switching between A.F.S. and A.F.C. Set the focusing area by selecting an AF point. (p.47) Faster autofocus performance than the contrast detection AF is possible.</p>
Shooting with Live View	<p>Contrast detection AF: Face Detection and Tracking are available. (p.48)</p>

Memo

- You can use the **AF** button to focus on the subject. The **AF** button operation can be set in [Button Customization] of the **4** menu. (p.79)

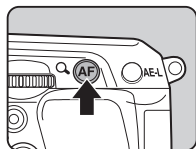

Setting the AF Mode when Shooting with the Viewfinder

- Turn  while pressing **AF MODE**.

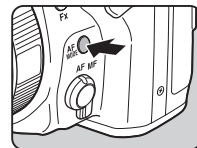

A.F.S. Single mode	<p>When the shutter release button is pressed halfway and the subject comes into focus, the focus is locked at that position. The AF assist light turns on as necessary.</p>
A.F.C. Continuous mode	<p>The subject is kept in focus by continuous adjustment while the shutter release button is pressed halfway.  appears in the viewfinder when the subject comes into focus. The shutter can be released even if the subject is not in focus.</p>
A.F.A. Auto-select mode	<p>Switches automatically between A.F.S. and A.F.C. modes according to the subject.</p>

Memo

- The following settings for autofocus operation can be set in the **C3** menu.

15. AF.S Setting	Focus-priority, Release-priority
16. 1st Frame Action in AF.C	Release-priority, Auto, Focus-priority
17. Action in AF.C Continuous	Focus-priority, Auto, FPS-priority
18. Hold AF Status	Off, Low, Medium, High





In [18. Hold AF Status], you can set whether to immediately reactivate autofocus or to maintain the focus for a certain amount of time before reactivating autofocus when the subject happens to move out of the selected focusing area after being focused. The default setting is to immediately reactivate autofocus when the subject moves out of focus.



- In  mode, the autofocus mode is fixed to **AF.A**.



Selecting the Focusing Area (AF Point)



1 Turn while pressing .

 Auto (27 AF Points)	Out of the 27 AF points, the camera automatically selects the optimum focusing area.
 Zone Select	Out of the selected 9 AF points, the camera automatically selects the optimum focusing point.
 Select	Sets the focusing area to the user selected point from 27 points.
 Expanded Area AF (S)	Sets the focusing area to the user selected point from 27 points. When the subject happens to move out of the selected focusing area after being focused, 8 peripheral points are used as back-up points. Not available in AF.S mode.



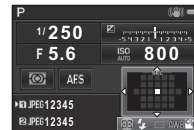

 Expanded Area AF (M)	Sets the focusing area to the user selected point from 27 points. When the subject happens to move out of the selected focusing area after being focused, 24 peripheral points are used as back-up points. Not available in AF.S mode.
 Expanded Area AF (L)	Sets the focusing area to the user selected point from 27 points. When the subject happens to move out of the selected focusing area after being focused, 26 peripheral points are used as back-up points. Not available in AF.S mode.
 Spot	Sets the focusing area to the center of the 27 points.

Proceed to Step 2 when a mode other than  or  is selected.

2 Select the desired AF point.



Available operations

	Changes the AF point.
	Returns the AF point to the center.
	Switches the function of the arrow keys () to the Change AF Point mode or the direct key operation.

Setting the AF Mode during Live View



You can select an autofocus mode when shooting with Live View in [Live View] of the 3 menu, or in [Contrast AF] of the control panel. The autofocus mode can also be changed by turning while pressing during Live View.

Face Detection	Detects and tracks faces of people. The main face detection frame for AF and AE is displayed in yellow.
Tracking	Tracks the subject in focus. The shutter can be released even if the subject is not in focus.
Multiple AF Points	Sets the focusing area to the desired area. The sensor is divided into 45 areas (9 horizontal by 5 vertical), and you can select a wider or narrower focusing area by using 1, 9, 15, or 21 of those 45 available areas.
Select	Sets the focusing area by the pixel.
Spot	Sets the focusing area to a limited area at the center.

⚠ Caution

- When is selected, the focus lock operation (composition adjustment with the half press of the shutter release button) does not work.

Selecting the Desired Focusing Area

You can set the position and range of the autofocusing area (AF area).

1 Set the autofocus mode to or .

2 Press .

3 Select the AF area.

Use the frame that appears on the monitor to change the position and size of the AF area.

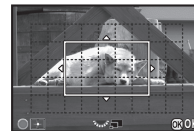

Available operations

Changes the position of the AF area.

Increases/reduces the size of the AF area (when is selected).

Returns the AF area to the center.

4 Press .

The AF area is set.

Memo

- When [Focus Peaking] is set to [ON] in [Live View] of the 3 menu, the outline of the subject in focus is emphasized and makes it easier to check the focus. This function works in both **AF** and **MF** modes.

You can precisely fine tune your lenses with the camera's autofocus system.

1 Select [25. AF Fine Adjustment] in C4 menu and press ►.

The [25. AF Fine Adjustment] screen appears.

2 Select [Apply All] or [Apply One] and press OK.

Apply All	Applies the same adjustment value to all lenses.
Apply One	Saves an adjustment value for the lens being used. (Up to 20 values)

3 Select [Setting] and adjust the value.



Available operations

►/☀️ to Adjusts the focus to a closer position.
the right

◀️/☀️ to Adjusts the focus to a farther position.
the left

○ Resets the adjustment value to the default setting.

4 Press OK.

The adjustment value is saved.

5 Press MENU twice.

The camera returns to standby mode.

Turn the main switch to to use the preview function.

There are two preview methods.

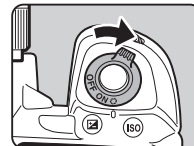

Optical Preview	Activates the Optical Preview function to check the depth of field with the viewfinder.
Digital Preview	Activates the Digital Preview function to check the composition, exposure and focus on the monitor. (The maximum display time: 60 seconds) You can magnify the image or save the preview image.

Setting the Preview Method



1 Select [Button Customization] in C4 menu and press ►.

The [Button Customization] screen appears.

2 Select [Preview Dial] and press ►.





The [Preview Dial] screen appears.

3 Select [Optical Preview] or [Digital Preview] and press OK.

4 Press MENU three times.

The camera returns to standby mode.

Memo







- Optical Preview is always used when the drive mode is set to [Mirror Lock-up Shooting], [Multi-exposure], [Interval Shooting], or [Interval Composite], or when [ASTROTRACER] is activated.
- The display settings and camera operation during Digital Preview can be changed in [Digital Preview] of the  4 menu. (p.22)
- The preview function can also be assigned to . (p.80)
You can easily switch between Optical Preview and Digital Preview after assigning different kinds of preview methods to the two controls,  of the main switch and .





Caution

- The effects of some functions cannot be checked during Digital Preview or are not applied to the saved preview image.

Setting the Drive Mode

You can choose from the following drive modes.







Single Frame Shooting ()	Normal capture mode
Continuous Shooting ()	Continuously takes pictures while the shutter release button is kept pressed. (p.51) The number of pictures that can be taken continuously varies according to the selected mode (H/M/L).
Self-timer ()	Releases the shutter about 12 seconds or 2 seconds after the shutter release button is pressed. (p.51)
Remote Control ()	Enables shooting with remote control. (p.52) Select from [Remote Control], [Remote Control (3 sec. delay)], or [Remote Continuous Shooting].
Exposure Bracketing ()	Takes consecutive pictures at different exposure levels. (p.52) Select from [Exposure Bracketing], [Self-timer+Exposure Bracketing], or [Exposure Bracket+Remote Ctrl].
Mirror Lock-up Shooting (MUP/ )	Takes images with the mirror raised. (p.53) Select from [Mirror Lock-up Shooting] or [Remote Control+Mirror Lock-up].
Multi-exposure ()	Creates a composite image by taking multiple pictures and merging them into a single image. (p.53) Select from [Multi-exposure], [Multi-exposure+Continuous], [Self-timer+Multi-exposure], or [Remote Control+Multi-exposure].

Interval Shooting ()	Takes pictures at a set interval from a set time. (p.54)
Interval Composite ()	Takes pictures at a set interval from a set time and merges them into a single image. Star and moon trails can be captured in one image. (p.54)
Interval Movie Record ()	Takes pictures at a set interval from a set time and saves them as a single movie file. (p.55) Available only in  mode.

⚠ Caution



- There are restrictions on some drive modes when used in combination with some other functions. (p.88)

📝 Memo

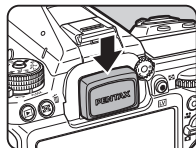



- Only , , or  can be selected in  mode.
- The Drive Mode setting is saved even after the power is turned off. If [Drive Mode] is set to  (Off) in [Memory] of the 4 menu, the setting returns to [Single Frame Shooting] when the power is turned off. (p.83)
- The [Shake Reduction] of the 3 menu is automatically set to [OFF] when the drive mode is set to [Self-timer], [Remote Control], or [Mirror Lock-up Shooting].
- When the drive mode that employs the self-timer or remote control is selected, exposure may be affected by the light entering through the viewfinder. In such a case, use the AE Lock function or attach the optional ME viewfinder cap. Remove the eyecup before attaching the ME viewfinder cap.

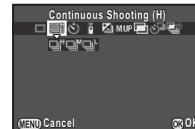

Continuous Shooting

- 1 Press  in standby mode.**
The Drive Mode screen appears.
- 2 Select  and press .**





- 3 Select , , or  and press .**
The camera returns to standby mode.

📝 Memo

- When the autofocus mode is set to **A.F.S.**, the focus position is locked in the first frame.

Self-timer

- 1 Press  in standby mode.**
The Drive Mode screen appears.
- 2 Select  and press .**

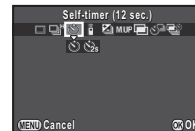

- 3 Select  or  and press .**
The camera returns to standby mode.
- 4 Press the shutter release button halfway, and then fully.**
The self-timer lamp blinks.
The shutter is released after about 12 seconds or 2 seconds.

Remote Control

- 1 Press **▲** in standby mode.
The Drive Mode screen appears.

- 2 Select **i** and press **▼**.



- 3 Select **i**, **i_{AS}**, or **i_{FC}** and press **OK**.
The camera returns to standby mode.
The self-timer lamp blinks.

- 4 Press the shutter release button halfway.

- 5 Point the remote control unit towards the remote control receiver on the front or back of the camera, and press the shutter release button on the remote control unit.

Memo

- The maximum operating distance of the remote control unit is approx. 4 m from the front of the camera and approx. 2 m from the back of the camera.
- To adjust focus with remote control, set in [19. AF with Remote Control] of the **C3** menu.
- When using the Remote Control Waterproof O-RC1, the autofocus system can be operated with the **1/∞** button on the remote control unit. The **Fn** button cannot be used.

Exposure Bracketing

- 1 Press **▲** in standby mode.
The Drive Mode screen appears.

- 2 Select **☰** and press **▼**.

- 3 Select **☰**, **☰**, or **☰** and press **▼**.

- 4 Use **☰** to select the number of shots.
Select from [2 images (+)], [2 images (-)], [3 images], or [5 images].

- 5 Set the bracket value.



Available operations

	Changes the bracket value (up to ± 2 EV).
	Adjusts the exposure compensation value.
	Resets the compensation value to the default setting.

- 6 Press **OK**.
The camera returns to standby mode.

- 7 Take the set number of pictures.
After pictures are taken, the camera returns to standby mode in Step 6.

Memo

- The bracket value can be set in increments of 1/3 EV steps or 1/2 EV steps according to the [1. EV Steps] setting of the **C1** menu.
- The following settings for the Exposure Bracketing can be set in the **C2** menu.

8. Bracketing Order	Changes the shooting order of pictures.
9. One-Push Bracketing	Takes all pictures with one release of the shutter.

Mirror Lock-up Shooting

- 1 Press ▲ in standby mode.**
The Drive Mode screen appears.

- 2 Select M.U.P. and press ▼.**



- 3 Select M.U.P. or M.U.P. and press OK.**
The camera returns to standby mode.

- 4 Press the shutter release button halfway, and then fully.**
The mirror pops up and the AE Lock function is activated.

- 5 Press the shutter release button fully again.**
The mirror returns to its original position after the image is taken.

Memo

- The mirror automatically returns to its original position if 1 minute elapses after the mirror pops up.



Caution

- Mirror Lock-up Shooting cannot be selected when shooting with Live View.

Multi-exposure

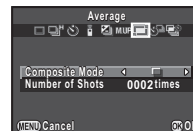

- 1 Press ▲ in standby mode.**
The Drive Mode screen appears.
- 2 Select [M.U.P.] and press ▼.**
- 3 Select [Average], [Additive], [Bright], or [M.U.P.], and press ▼.**
- 4 Select [Composite Mode].**



 Average	Creates a composite image with the average exposure.
 Additive	Creates a composite image with the cumulatively added exposure.
 Bright	Creates a composite image that combines only bright parts.



- 5 Specify [Number of Shots].**
Select from 2 to 2000 times.
- 6 Press OK.**
The camera returns to standby mode.
- 7 Shoot.**
Instant Review is displayed.

Available operations during Instant Review

-  Discards pictures taken up to that point and takes pictures again from the first picture.
-  Saves pictures taken up to that point and displays the  menu.

After the set number of pictures are taken, the camera returns to standby mode.

Interval Shooting

- 1 Press  in standby mode.**
The Drive Mode screen appears.
- 2 Select  and press .**
- 3 Set the shooting conditions.**

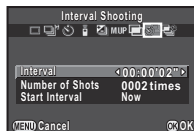

Interval	Select from 2 seconds to 24 hours.
Number of Shots	Select from 2 to 2000 times.
Start Interval	Select whether to take the first picture now or at a set time. When [Set Time] is selected, set the time at which to start shooting in [Start Time].

- 4 Press .**
The camera returns to standby mode.

5 Shoot.

When [Start Interval] is set to [Now], the first picture is taken. When set to [Set Time], shooting starts at the set time.



Instant Review is displayed, and then the monitor turns off. To cancel shooting, press the shutter release button halfway, and press  in standby mode.

After the set number of pictures are taken, the camera returns to standby mode.

Memo

- The shortest interval times that can be set for [Interval] are 10 and 20 seconds for [Digital Filter] and [HDR Capture] of the 1 menu, respectively.

Interval Composite

- 1 Press  in standby mode.**
The Drive Mode screen appears.
- 2 Select  and press .**
- 3 Set the shooting conditions.**

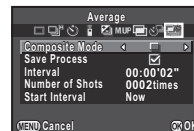

Composite Mode	Select from [Average], [Additive], or [Bright]. (Refer to "Multi-exposure" (p.53).)
Save Process	Select <input checked="" type="checkbox"/> to save images in the middle of processing.
Interval	Select from 2 seconds to 24 hours.
Number of Shots	Select from 2 to 2000 times.
Start Interval	Select whether to take the first picture now or at a set time. When [Set Time] is selected, set the time at which to start shooting in [Start Time].

4 Press **OK to finish the setting.**

The camera returns to standby mode.

5 Shoot.

When [Start Interval] is set to [Now], the first picture is taken. When set to [Set Time], shooting starts at the set time.

To cancel shooting, press **MENU** in standby mode. After the set number of pictures are taken, the camera returns to standby mode.

Memo

- Mount the camera on a tripod during shooting.

Interval Movie Record

In **1** mode, you can use [Interval Movie Record] to take still pictures at a set interval from a set time and save them as a single movie file (Motion JPEG, file extension: .AVI).

1 Turn the capture mode selector switch to **1 and press **▲**.**

The Drive Mode screen appears.

2 Select **1 and press **▼**.****3 Set the shooting conditions.**

Recorded Pixels	Select from 4K , FullHD , or HD .
Interval	Select from [2sec.], [5sec.], [10sec.], [20sec.], [30sec.], [1min.], [5min.], [10min.], [30min.], or [1hr.].

Recording Time	Set the time from the start to the end of recording. Select from 14 seconds to 99 hours. The time that can be set varies depending on the [Interval] setting.
Start Interval	Select whether to take the first picture now or at a set time. When [Set Time] is selected, set the time at which to start shooting in [Start Time].

4 Press **OK to finish the setting.**

The camera returns to standby mode.

5 Press the shutter release button to start shooting.

When [Start Interval] is set to [Now], the first picture is taken.

Instant Review is displayed, and then the monitor turns off.

To cancel shooting, press the shutter release button halfway, and press **MENU** in standby mode.

After the set number of pictures are taken, the camera returns to standby mode.

Memo

- The shortest interval times that can be set for [Interval] are 10 and 20 seconds for [Digital Filter] and [HDR Capture] of the **1** menu, respectively.

Setting the White Balance

- 1** Press **◀** in standby mode.
The White Balance setting screen appears.

- 2** Select the desired white balance setting.



AWB	AWB Auto White Balance ☰ _A Multi Auto White Balance
☀	Daylight
🏠	Shade
☁	Cloudy
☀	☰ _A Fluorescent - Daylight Color ☰ _A Fluorescent - Daylight White ☰ _A Fluorescent - Cool White ☰ _A Fluorescent - Warm White
☀	Tungsten
🔆	Flash
CTE	Color Temperature Enhancement
🖨	Manual White Balance 1 to 3
K	Color Temperature 1 to 3

Available operations when shooting with the viewfinder

Main switch to ☰	Uses Digital Preview to preview the background image with the white balance setting applied.
AE-L	Saves the preview image (only when the image can be saved).

Proceed to Step 5 if you do not need to fine-tune the white balance.

- 3** Press **INFO**.
The fine-tuning screen appears.



Available operations

-
- ▲▼ Adjust: Green-Magenta

 - ◀▶ Adjust: Blue-Amber

 - Resets the adjustment value to the default setting.

- 4** Press **OK**.
The screen of Step 2 reappears.

- 5** Press **OK**.
The camera returns to standby mode.

⚠ Caution

- The Digital Preview operation in Step 2 cannot be performed when the drive mode is set to [Multi-exposure], [Interval Shooting], or [Interval Composite].

📝 Memo

- When **☰_A** is set, even if various light sources are present at the shooting location, the camera automatically adjusts the white balance according to the light source of each area. (**☰_A** is not available in **🖨** mode.)
- The following settings for the white balance can be set in the **C2** menu.

10. WB Adjustable Range	Fixed, Auto Adjustment
11. WB When Using Flash	Auto White Balance, Multi Auto White Balance, Flash, Unchanged
12. AWB in Tungsten Light	Strong Correction, Subtle Correction
13. Color Temperature Steps	Kelvin, Mired

Adjusting the White Balance Manually

You can measure the white balance at a selected location.

1 Select  in Step 2 on “Setting the White Balance” (p.56) and press .

2 Select from  1 to  3.



3 Under the light you wish to measure the white balance of, select a white area as the subject, and press the shutter release button fully.

The captured image is displayed.



4 Use , , , and  to specify the measuring area.

5 Press .

The White Balance setting screen reappears.

[The operation could not be completed correctly] appears when measuring is unsuccessful. Press  to remeasure the white balance.

Memo

- You can copy the white balance settings of a captured image and save them as  1 to  3 in [Save as Manual WB] of the playback mode palette. (p.67)

Adjusting the White Balance with Color Temperature

Specify the white balance with the color temperature.

1 Select **K** in Step 2 on “Setting the White Balance” (p.56), and press .

2 Select from **K 1** to **K 3**.

3 Press .

4 Adjust the color temperature.

Set the color temperature value within the range from 2,500K to 10,000K.



Available operations



Changes the color temperature in increments of 100 Kelvin.



Changes the color temperature in increments of 1,000 Kelvin.





Fine-tunes the color temperature.

5 Press .

The White Balance setting screen reappears.

Memo

- Select [Mired] in [13. Color Temperature Steps] of the **C2** menu to set the color temperature in mired units. The color temperature can be changed in 20 mired units with , and 100 mired units with . However, figures are converted to and displayed in Kelvin.

Controlling the Image Finishing Tone

When you want to take pictures with a slightly different style, you can set the desired picture style before shooting.

Try out the various settings, and find your best picture style.

3

Shooting

Custom Image

1 Press **▶** in standby mode.

The Custom Image setting screen appears.

2 Select an image finishing tone.



Bright (default setting)

Natural

Portrait

Landscape

Vibrant

Radiant

Muted

Bleach Bypass

Reversal Film

Monochrome

Cross Processing

Available operations when shooting with the viewfinder

Main switch to Uses Digital Preview to preview the background image with the selected setting applied.

Saves the preview image (only when the image can be saved).

Proceed to Step 6 if you do not need to change the parameters.

3 Press **INFO**.

The parameter setting screen appears.

4 Set the parameters.



Available operations

- Selects a parameter.
- Adjusts the value.
- Switches between [Contrast], [Highlight Adjustment], and [Shadow Adjustment].
- Switches between [Sharpness], [Fine Sharpness], and [Extra Sharpness]. (Not available in mode).
- Resets the adjustment value to the default setting.

5 Press **OK**.

The screen of Step 2 reappears.

6 Press **OK**.

The camera returns to standby mode.

Caution

- This function is not available when in mode.
- The Digital Preview operation in Step 2 cannot be performed when the drive mode is set to [Multi-exposure], [Interval Shooting], or [Interval Composite].

Saving the Cross Processing Settings of a Captured Image

The outcome of Cross Processing varies each time a picture is taken. If you take a cross processed image that you like, you can save the Cross Processing settings used in the image so that you can repeatedly use the same settings.

1 Press in single image display of playback mode.

The playback mode palette appears.

2 Select and press .

The camera searches for cross processed images starting from the most recent image taken.

[No cross processed image] appears if there are no cross processed images.

3 Use to select a cross processed image.



4 Select the "Favorite" number 1, 2 or 3 to save the settings, and press .

The settings of the selected image are saved as your "Favorite" settings.

Memo

- The saved Cross Processing settings can be loaded by selecting [Cross Processing] in Step 2 of "Custom Image" (p.58), and selecting one of the Favorite settings 1 to 3 for the parameter.

Digital Filter



1 Select [Digital Filter] in 1 or 1 menu and press .

The Digital Filter setting screen appears.

2 Select a filter.

Select [No Filter] to not shoot with a digital filter.



Extract Color
Toy Camera
Retro
High Contrast

Shading
Invert Color
Unicolor Bold
Bold Monochrome

Available operations when shooting with the viewfinder

Main switch to  Uses Digital Preview to preview the background image with the selected effect applied.

 Saves the preview image (only when the image can be saved).

Proceed to Step 6 if you do not need to change the parameters.

3 Press .

The parameter setting screen appears.

4 Set the parameters.

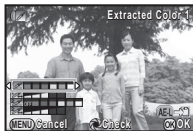

Available operations

- ▲▼ Selects a parameter.
- ◀▶ Adjusts the value.

5 Press **OK**.

The screen of Step 2 reappears.

6 Press **OK**.

7 Press **MENU**.

The camera returns to standby mode.

⚠ Caution

- This function cannot be used in combination with some other functions. (p.88)
- The Digital Preview operation in Step 2 cannot be performed when the drive mode is set to [Multi-exposure], [Interval Shooting], or [Interval Composite].
- Depending on the filter used, it may take longer to save images.

📌 Memo

- Still images can also be processed with digital filters in playback mode. (p.74)

Correcting Images

Brightness Adjustment

Highlight Correction/Shadow Correction



Expands the dynamic range and enables a wider range of tones to be recorded by the CMOS sensor and reduces the occurrence of overexposed/underexposed areas. Set the correction functions from [D-Range Settings] of the menu or the control panel.

⚠ Caution

- When the sensitivity is set to less than ISO 200, [Highlight Correction] cannot be set to [ON].

📌 Memo

- [Highlight Correction] in mode can be set to [AUTO] or [OFF].

HDR Capture



Takes three consecutive images at three different exposure levels to create a single composite image with them.

1 Select [HDR Capture] in menu and press **▶**.

The [HDR Capture] screen appears.

2 Select the capture type and press **OK**.

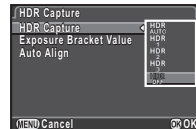

3 Set the range in which to change the exposure in [Exposure Bracket Value].

Select from [±1EV], [±2EV], or [±3EV].

4 Set whether to use Auto Align or not.

<input checked="" type="checkbox"/>	Uses Auto Align.
<input type="checkbox"/>	Does not use Auto Align.

5 Press **MENU** twice.

The camera returns to standby mode.

⚠ Caution

- HDR Capture is not available in **■**, **B**, or **X** mode.
- This function cannot be used in combination with some other functions. (p.88)
- When the drive mode is set to [Interval Shooting], [Auto Align] is fixed to (Off).
- In **📹** mode, HDR Capture is available only when the drive mode is set to [Interval Movie Record].
- For HDR Capture, multiple images are combined together to create a single image, so it may take time to save the image.

Lens Correction



The following features can be set in [Lens Correction] of the **📷2** menu.

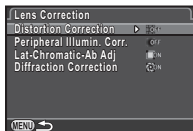

Distortion Correction	Reduces distortions occurring due to lens properties.
Peripheral Illumin. Corr.	Reduces peripheral light fall-off occurring due to lens properties.
Lat-Chromatic-Ab Adj	Reduces lateral chromatic aberrations occurring due to lens properties.
Diffraction Correction	Corrects blur caused by diffraction when using a small aperture.

📌 Memo

- You can also set [Distortion Correction] and [Peripheral Illumin. Corr.] from the control panel.
- Corrections can only be made when a compatible lens is attached. (p.89) The features are disabled when using an accessory such as a rear converter that is attached between the camera and the lens.
- When [File Format] is set to [RAW] or [RAW+], correction information is saved as a RAW file parameter and you can select whether to apply the correction to the images when developing them. For the RAW Development function, [Color Fringe Correction] can also be set. (p.77)

High-Definition Image Output



Pixel Shift Resolution is the feature that enables outputting a high-definition image of a stationary object by merging four images shifted by one pixel using the Shake Reduction mechanism.

Set [Pixel Shift Resolution] to [ON] in the **📷1** menu or the control panel.

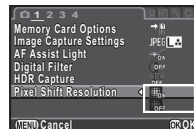

⚠ Caution

- This function cannot be used in the following situations.
 - In **■**, **B**, or **X** mode
 - In **📹** mode
- This function cannot be used in combination with some other functions. (p.88)
- While this function is used, [Shake Reduction] of the **📷3** menu is fixed to [OFF].

📌 Memo

- When taking pictures with Pixel Shift Resolution, use a tripod and mount the camera on it securely. The use of Self-timer, Remote Control, or Mirror Lock-up Shooting is also effective.

Anti-Aliasing Filter Simulator



By shaking the Shake Reduction unit, a moiré reduction effect simulating that of a low-pass filter can be achieved.

- 1 Select [AA Filter Simulator] in menu and press **▶**.
- 2 Select a type and press **OK**.



TYPE1	Takes pictures balancing the resolution and moiré reduction.
TYPE2	Prioritizes moiré reduction.
Bracketing	Takes consecutive 3 images in order of [Off], [TYPE1], and [TYPE2] (3 images are taken with one press of the shutter release button).

⚠ Caution

- This function cannot be used in some capture modes or in combination with some other functions. (p.88)
- [Bracketing] cannot be selected in the following situations.
 - In **B** mode
 - When the drive mode is set to other than [Single Frame Shooting], [Self-timer] (12 seconds, 2 seconds), or [Remote Control] (now, after 3 seconds)
 - When HDR Capture is set
 - When the number of storable images is 2 or less
- When the shutter speed is faster than 1/1000 seconds, the full effect of this function cannot be achieved.

Composition Adjustment



By using the Shake Reduction mechanism, the composition of the image can be adjusted. Use this function when you want to adjust the composition, such as when using a tripod during Live View shooting.

- 1 Select [Live View] in menu and press **▶**.
The [Live View] screen appears.
- 2 Select [Composition Adjust.] and set to .
- 3 Press **MENU** twice.
The camera returns to standby mode.
- 4 Press **LV**.
Live View is displayed and the message [Adjust the composition of the image] appears.
- 5 **Adjust the composition.**

The amount of adjustment (the number of steps) is displayed at the top right of the screen.



Available operations

- Moves the composition of the image (up to 24 steps).
- Adjusts the level of the composition (up to 8 steps. Not available when the amount of adjustment to move the composition is 17 steps or more).
- Resets the adjustment value to the default setting.

6 Press .

The camera returns to standby mode in Live View.

Caution

- This function cannot be used in the following situations.
 - When the drive mode is set to [Interval Shooting], [Interval Composite], or [Interval Movie Record]
 - When using the ASTROTRACER function



Memo

- The adjusted composition is saved even if Live View is ended or the camera is turned off. To reset the saved adjustment value when Live View is ended, set [Composition Adjust.] to (Off) in [Memory] of the 4 menu. (p.83)

Using the GPS

The following functions are available with the camera's built-in GPS unit.

GPS Logging	Saves the GPS positioning data received periodically to the memory card. (p.65)
ASTROTRACER	Tracks and captures celestial bodies. (p.66) By matching the movement of the built-in Shake Reduction unit with the movement of celestial bodies, celestial bodies can be captured as individual points even when shooting with a long exposure setting.
GPS Time Sync	Automatically adjusts the camera's date and time settings using information obtained from GPS satellites. (p.64)

Press  to turn the GPS on. A beep sounds and the GPS indicator lamp lights up. Press  again to turn the GPS off.

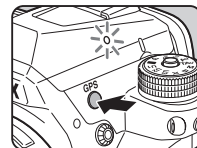

You can check the GPS positioning status on the status screen and Live View screen.

GPS positioning status

Green	3D positioning
Yellow	2D positioning
Red	No positioning



When a picture is taken while the GPS is on, the GPS data is recorded in the image. The GPS data is not recorded in movies. You can check the GPS information in Detailed Information Display in playback mode. (p.15)

⚠ Caution

- You cannot turn the GPS on/off while recording a movie.
- While the GPS is on, the battery drains faster than normal.
- If you use the camera near objects which generate a magnetic field such as magnets, or have magnetism such as iron, the electronic compass may not work properly.
- The GPS data recorded in the image cannot be deleted. If you do not want to share the shooting location information with the public when posting the image on SNS, etc., turn the GPS off before shooting.
- You cannot use the optional GPS unit O-GPS1 with this camera.
- For other precautions on the GPS, refer to “About the GPS” (p.108).

📝 Memo

- When the GPS information can be obtained, Coordinated Universal Time (UTC) is recorded as the shooting date and time for images. On the Electronic Compass screen (p.13), the time is displayed after the difference between UTC and the time of the shooting location is corrected.

Setting Additional Features for the GPS Operation



[GPS Time Sync] and [GPS Indicator Lamp] can be turned on/off in [Additional Settings] of [GPS] in the 2 menu.

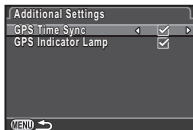

Performing a Calibration



Adjust the camera to obtain the direction information accurately.

1 Select [GPS] in 2 menu and press ►.

The [GPS] screen appears.



2 Select [Calibration] and press ►.

The [Calibration] screen appears.

3 Rotate the camera according to instructions displayed on the monitor.

The result of calibration appears.

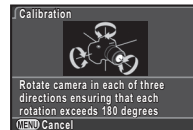

4 Press .

The [GPS] screen reappears.

⚠ Caution

- When performing a calibration, be careful not to drop the camera. Wrap the strap around your wrist or take other measures.
- If [The operation could not be completed correctly] appears as the result of calibration in Step 3, change the camera direction and perform a calibration again.

📝 Memo

- If the battery is removed, perform a calibration again after the battery is put back in.
- If [ASTROTRACER] is set to [ON], [Precise Calibration] appears in the [GPS] screen instead of [Calibration]. As the magnetic field varies depending on the shooting location, precise calibration must be performed at each location when shooting images of celestial bodies with ASTROTRACER.

Recording the Camera Route (GPS Logging)



1 Select [GPS] in menu and press ►.

The [GPS] screen appears.

2 Select [GPS Logging] and press ►.

The [GPS Logging] screen appears.

3 Set the logging conditions.

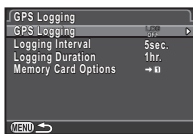

Logging Interval	Select from [5sec.], [10sec.], [15sec.], [30sec.], or [1min.].
Logging Duration	Select from [1hr.] to [24hr.]. (When [Logging Interval] is set to [5sec.], select from [1hr.] to [9hr.]. When [Logging Interval] is set to [10sec.], select from [1hr.] to [18hr.].)
Memory Card Options	Select the SD1 card or the SD2 card.

4 Select [GPS Logging] and press ►.

The confirmation screen appears.

5 Select [Start] and press .

The GPS turns on and GPS logging starts.

The screen of Step 3 reappears.

Caution

- GPS log data cannot be recorded when the camera is connected by USB to a computer.

Memo

- During GPS logging, “LOG” is displayed under the GPS positioning status icon on the status screen and Live View screen. When the time set in [Logging Duration] elapses, “LOG END” is displayed and a GPS log file is saved.
- Select [Exit] in Step 5 to stop GPS logging. A GPS log file is saved.
- When the GPS is turned off by pressing , GPS logging stops temporarily. (The countdown for [Logging Duration] continues.) GPS logging starts again when the GPS is turned on.
- If there is GPS log data to be saved as a log file, “LOG END” is displayed in [GPS Logging] on the screen of Step 3. Select [Save] in Step 5 to save the GPS log file.
- During GPS logging, you cannot change the settings of [Logging Interval] and [Logging Duration].
- A log file (KML format) is saved in the “GPSLOG” folder in the memory card with a file name of sequential number from 001 to 999 and month and day (example: 001_0505). However, if there is no GPS log data to be saved, neither a log file nor a folder is created. In addition, if the log file “999_****” has been already saved, a new log file cannot be saved.
- You can display the camera route on the Google Earth, etc. by transferring a log file to a computer and importing it.

Shooting Celestial Bodies (ASTROTRACER)



1 Set the Exposure Mode to **B** and set the Focus Method to **MF**.

2 Press **GPS**.

3 Select **[GPS]** in **☰2** menu and press **▶**.
The [GPS] screen appears.

4 Select **[ASTROTRACER]** and press **▶**.

5 Select **☰** and press **OK**.

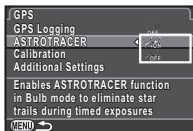

6 Select **[Precise Calibration]** and press **▶**.
Refer to "Performing a Calibration" (p.64).

7 Press **MENU** twice.
The camera returns to standby mode.

8 Set the shooting conditions.

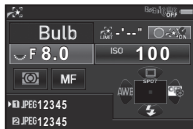

Available operations

- | | |
|--|--|
| | Enables/Disables the timed exposure. |
| | Changes the exposure time within the range from 0'10" to 5'00" when the timed exposure is enabled. |
| | Changes the aperture value. |

9 Adjust the focus and press the shutter release button fully.

Shooting starts.

10 Press the shutter release button fully again.

Shooting stops.

When the timed exposure is enabled, shooting stops automatically after the set time has elapsed.

⚠ Caution









- This function cannot be used in combination with some other functions. (p.88)





Playback Mode Palette Items

Playback functions can be set from the playback mode palette as well as the 1 menu (p.24).

Press  in single image display of the playback mode to display the playback mode palette.



Item	Function	Page
 Image Rotation *1	Changes the rotation information of images.	p.70
 Digital Filter *1	Processes images with digital filters.	p.74
 Color Moiré Correction *1 *2	Reduces color moiré in images.	p.73
 Resize *1 *2	Changes the number of recorded pixels of the image.	p.73
 Cropping *1	Crops out only the desired area of an image.	p.73
 Index	Joins a number of images together and creates an index image with them.	p.75
 Protect	Protects images from being accidentally erased.	p.83
 Slideshow	Plays back images one after another.	p.69
 Save as Manual WB *1	Saves the white balance settings of the captured image as Manual White Balance.	p.57

Item	Function	Page
 Save Cross Processing	Saves the settings used for an image captured in Cross Processing mode of Custom Image as your "Favorite" settings.	p.59
 RAW Development *3	Develops RAW images into JPEG images and saves them as new files.	p.77
 Movie Edit *4	Divides a movie or deletes unwanted segments.	p.76
 Image Copy	Copies images between cards in the SD1 and the SD2 slots.	p.72
 Eye-Fi Image Transfer *1 *5	Transfers selected images wirelessly using an optional Eye-Fi card.	p.86

*1 Not available when a movie is displayed.



*2 Not available when a RAW image is displayed.

*3 Available only when a RAW image is saved.

*4 Available only when a movie is displayed.

*5 Available only when an Eye-Fi card is inserted in the SD2 slot.

Memo

- The functions of the 1 menu and playback mode palette can be used only for the images saved on the memory card that is currently being played back. To use the functions for the images saved on the other memory card, switch to the other memory card slot with  during single image display, and then display the 1 menu or playback mode palette.

Changing the Playback Method

Displaying Multiple Images



You can display 6, 12, 20, 35, or 80 thumbnail images at the same time.

1 Turn to the left in playback mode.

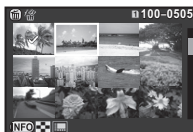
The multi-image display screen appears.



Available operations

- | | |
|---|---|
|  | Moves the selection frame. |
|  | Shows the next/previous page. |
|  | Switches between the SD1 card and the SD2 card. |

- | | |
|---|---|
|  | Shows the display style selection screen. |
|---|---|



- | | |
|---|-----------------------------|
|  | Deletes the selected image. |
|---|-----------------------------|

2 Press .





The selected image appears in single image display.

Deleting Selected Images



- 1 Press  in Step 1 of "Displaying Multiple Images" (p.68).
- 2 Select the images to delete.



Available operations

- | | |
|---|---|
|  | Moves the selection frame. |
|  | Confirms/cancels the selection of the image to delete. |
|  | Selects the range of images to delete. |
|  | Shows the selected image in single image display.
Use  to select a different image. |

In the upper left area of the monitor, the number of selected images is displayed.

- 3 Press .
- 4 Select [Delete] and press .

Memo

- You can select up to 500 images at a time.
- Protected images cannot be selected.
- You can delete the images selected individually along with the images selected by specifying the range to delete.
- Use the same steps to select multiple images for the following functions.
 - Image Copy (p.72)
 - Index (p.75)
 - RAW Development (p.77)
 - Protect (p.83)
 - Eye-Fi Image Transfer (p.86)

Displaying Images by Folder

- 1 Turn  to the left in Step 1 of "Displaying Multiple Images" (p.68).

The folder display screen appears.



Available operations

  Moves the selection frame.

 Deletes the selected folder.

- 2 Press .

The images in the selected folder are displayed.

Deleting a Folder

- 1 Select the folder to delete in Step 1 of "Displaying Images by Folder" (p.69), and press .

The delete confirmation screen appears.

- 2 Select [Delete] and press .

The selected folder and all the images in it are deleted. When there are protected images in the folder, select [Delete all] or [Leave all].

Displaying Images by Shooting Date

Images are grouped and displayed by shooting date.

- 1 Press  in Step 1 of "Displaying Multiple Images" (p.68).



The display style selection screen appears.

- 2 Select [Calendar Filmstrip Display].



Shooting Thumbnail
date

Available operations

  Selects a shooting date.

 Selects an image taken on the selected shooting date.

 to the right Shows the selected image in single image display.

 Deletes the selected image.

- 3 Press .

The selected image appears in single image display.

Playing Back Images Continuously (Slideshow)

- 1 Select  in the playback mode palette.

Slideshow starts.

Available operations

 Pauses/resumes playback.

 Displays the previous image.

 Displays the next image.

 Stops playback.

 Adjusts the sound volume of the movie.

After all images are played back, the camera returns to single image display mode.

Memo

- You can change the [Display Duration], [Screen Effect], [Repeat Playback], and [Auto Movie Playback] settings for slideshow in [Slideshow] of the **[1]** menu. Slideshow can also be started from the Slideshow setting screen.

Displaying Rotated Images

When you take pictures with the camera held vertically, image rotation information is saved when shooting. When [Auto Image Rotation] in the **[1]** menu is set to (On), the image is automatically rotated based on the rotation information during playback (default setting).

The rotation information of an image can be changed by following the procedure below.

1 Display the image to edit in single image display.

2 Select in the playback mode palette.

The selected image is rotated in 90° increments and the four thumbnail images are displayed.

3 Use **▲▼◀▶** to select the desired rotation direction and press **OK**.

The image rotation information is saved.



Caution

- When [22. Save Rotation Info] is set to [Off] in the **C4** menu, image rotation information is not saved when shooting.
- You cannot change image rotation information in the following cases.
 - Protected images
 - Images without a rotation information tag
- When [Auto Image Rotation] in the **[1]** menu is set to (Off)
- Movie files cannot be rotated.

Connecting the Camera to an AV Device

Connect to an AV device, such as a TV, equipped with an HDMI terminal to display Live View images while shooting or to play back images in playback mode.

Make sure to have a commercially available HDMI cable equipped with an HDMI terminal (type D).

1 Turn the AV device and camera off.

2 Open the terminal cover of the camera, and connect the cable to the HDMI terminal.

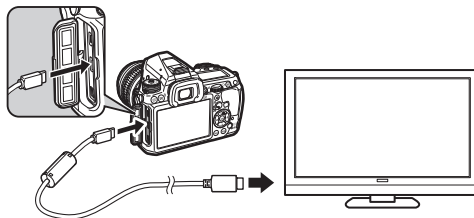

3 Connect the other end of the cable to the input terminal on the AV device.

4 Turn the AV device and camera on.

The camera turns on in HDMI mode, and the camera information is displayed on the screen of the connected AV device.

Caution

- While the camera is connected to an AV device, nothing is displayed on the camera monitor. Also, you cannot adjust the sound volume on the camera. Adjust the volume on the AV device.

Memo

- Check the operating manual of the AV device and select a suitable input terminal for connecting the camera.
- By default, the maximum resolution supported by both the AV device and camera is automatically selected. If it fails to play back images properly, change the setting in [HDMI Out] of the 2 menu.
- If you intend to use the camera continuously for a long period, the use of the optional AC adapter kit is recommended.

Connecting the Camera to a Computer

Connect the camera to a computer using a USB cable. Make sure to have a commercially available USB cable equipped with a micro B terminal.

- 1 Turn the computer on.**
- 2 Turn the camera off.**
- 3 Open the terminal cover of the camera, and connect the USB cable to the USB terminal.**

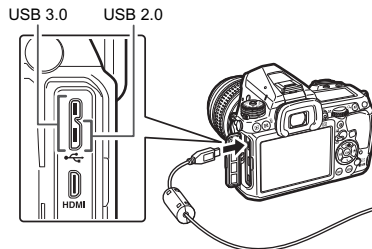

- 4 Connect the USB cable to the USB port of the computer.**
- 5 Turn the camera on.**
The camera is recognized as a removable disk.
- 6 Save the captured images to the computer.**
- 7 Disconnect the camera from the computer.**

⚠ Caution

- The camera cannot be operated while it is connected to a computer. To operate the camera, terminate the USB connection on the computer, then turn off the camera and remove the USB cable.
- If the "K-3 II" dialog appears on the computer screen in Step 5, select [Open folder to view files] and click the OK button.

📄 Memo

- Refer to "Operating Environment for USB Connection and Provided Software" (p.101) for system requirements to connect the camera to a computer and to use the software.
- The USB connection mode when connecting the camera to a computer can be set in [USB Connection] of the  menu. Normally, you do not need to change the default setting ([MSC]).
- If you intend to use the camera continuously for a long period, the use of the optional AC adapter kit is recommended.





USB Terminal

The micro B terminal supports both USB 3.0 cables and USB 2.0 cables. Both types can be used with this camera. If the host controller of the device to be connected to the camera supports USB 3.0, the data transfer speed is faster when a USB 3.0 cable is used.

Editing and Processing Images

Copying an Image

Copies images between memory cards in the SD1 and the SD2 slots.

- 1 Select an image saved on the memory card which the images are to be copied from, and display it in single image display.**
- 2 Select  in the playback mode palette.**
- 3 Select [Select image(s)] or [Select a folder] and press .**
- 4 Select image(s) or a folder.**
Refer to Step 2 of "Deleting Selected Images" (p.68) for how to select image(s).
- 5 Press .**
The save confirmation screen appears.
- 6 Select the location to save the image(s) or folder and press .**

Changing the Image Size

⚠ Caution

- Only JPEG images captured with this camera can be resized or cropped.
- Images already resized or cropped to the minimum file size cannot be processed.



Changing the Number of Recorded Pixels (Resize)

Changes the number of recorded pixels of the selected image, and saves it as a new file.

1 Display the image to edit in single image display.

2 Select  in the playback mode palette.

The screen to select the number of recorded pixels appears.

3 Use   to select the number of recorded pixels and press .

You can select an image size smaller than that of the original image.

The save confirmation screen appears.

4 Select [Save to SD1] or [Save to SD2] and press .



Cropping Out Part of the Image (Cropping)

Crops out only the desired area of the selected image and saves it as a new file.

1 Display the image to edit in single image display.

2 Select  in the playback mode palette.

The cropping frame to specify the size and position of the area to crop appears on the screen.

3 Specify the size and position of the area to crop by using the cropping frame.



Available operations



Changes the size of the cropping frame.



Moves the cropping frame.



Changes the Aspect Ratio or Image Rotation setting.



Rotates the cropping frame (only when possible).

4 Press .

The save confirmation screen appears.

5 Select [Save to SD1] or [Save to SD2] and press .



Correcting Color Moiré

Reduces color moiré in images.

1 Display the image to edit in single image display.

2 Select  in the playback mode palette.

If the image cannot be edited, [This image cannot be processed] appears.

3 Use   to select the correction level and press .

The save confirmation screen appears.



4 Select [Save to SD1] or [Save to SD2] and press .

● Caution

- The Color Moiré Correction function can be used only for the JPEG images captured with this camera.

Processing Images with Digital Filters

1 Display the image to edit in single image display.

2 Select **0** in the playback mode palette.

The screen to select a filter appears.

3 Select a filter.

Use  to select a different image.



Base Parameter Adj	Sketch
Extract Color	Water Color
Toy Camera	Pastel
Retro	Posterization
High Contrast	Miniature
Shading	Soft
Invert Color	Starburst
Unicolor Bold	Fish-eye
Bold Monochrome	Slim
Tone Expansion	

Proceed to Step 7 if you do not need to change the parameters.

4 Press **INFO**.

The parameter setting screen appears.

5 Set the parameters.



Available operations

  Selects a parameter.

  Adjusts the value.

6 Press **OK**.

The screen of Step 3 reappears.

7 Press **OK**.

The save confirmation screen appears.

8 Select **[Apply additional filter(s)]**, **[Save to SD1]**, or **[Save to SD2]**, and press **OK**.

Select **[Apply additional filter(s)]** when you want to apply additional filters to the same image. The screen of Step 3 reappears.

Caution

- Only JPEG and RAW images captured with this camera can be edited with the digital filters.
- RAW images captured using HDR Capture or Pixel Shift Resolution cannot be processed with Digital Filter.

Memo

- Up to 20 filters, including the digital filter used during shooting (p.59), can be applied to the same image.

Recreating Filter Effects

Retrieves the filter effects of the selected image and applies the same filter effects to other images.

1 Display a filter-processed image in single image display.

2 Select **0** in the playback mode palette.

3 Select [Recreating filter effects] and press **OK**.

The filter effects used for the selected image appear.



4 To check the parameter details, press **INFO**.

Press **INFO** again to return to the previous screen.



5 Press **OK**.

The image selection screen appears.

6 Use to select an image for applying the same filter effects, and press **OK**.

You can only select an image saved in the same memory card that has not been processed with a filter.

The save confirmation screen appears.



7 Select [Save to SD1] or [Save to SD2] and press **OK**.

Memo

- If [Searching for the original image] is selected in Step 3, the original image prior to digital filter application can be retrieved.







Creating a Composite Image (Index)

Joins a number of images together and creates a new image with them.

1 Select in the playback mode palette.

The Index setting screen appears.

2 Select [Layout].

Select from  (Thumbnail),  (Square),  (Random 1),  (Random 2),  (Random 3), or  (Bubble).

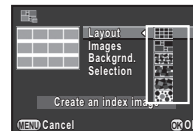





3 Select the number of images from 12, 24, or 36 in [Images].

When the number of saved images is smaller than the number selected, empty spaces will appear when [Layout] is set to  and some images are duplicated for other layouts.

4 Select the background color from white or black in [Backgrnd.].

5 Select a type of image selection in [Selection].

	Auto Select	Picks images automatically from all of the images saved.
	Select image(s)	Lets you select images that you want to include in the index image. If  is selected, [Select image(s)] appears and leads you to the image selection screen.
	Select a folder	Picks images automatically from the folder selected. If  is selected, [Select a folder] appears and leads you to the folder selection screen.

6 Select [Create an index image] and press **OK**.

The index image appears.

7 Select [Save to SD1], [Save to SD2], or [Reshuffle], and press **OK**.

When [Reshuffle] is selected, you can reselect the images to be included and display a new index image.

Memo

- The file name format for an index image is "INDX****.JPG".

Editing Movies

1 Display the movie to edit in single image display.

2 Select  in the playback mode palette.

The movie editing screen appears.





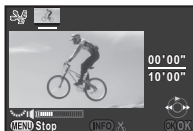

3 Select the point where you want to divide the movie.

The frame at the dividing point is displayed at the top of the screen.

Up to four points can be selected to divide the original movie into five segments.





Available operations

	Plays back/pauses a movie.
	Forwards a frame (when paused).
Press and hold 	Fast-forwards playback.
	Reverses a frame (when paused).
Press and hold 	Fast-reverses playback.
	Adjusts the sound volume.
	Confirms/cancels the selected dividing point.

Proceed to Step 7 if you do not want to delete any segment.

4 Press .

The screen to select the segments to delete is displayed.

5 Use   to move the selection frame and press .

The segments to delete are specified. (Multiple segments can be deleted at once.)

Press  again to cancel the selection.



6 Press .

The screen of Step 3 reappears.

7 Press .

The save confirmation screen appears.

8 Select [Save to SD1] or [Save to SD2] and press .

Memo

- Select dividing points in chronological order from the beginning of the movie. When canceling the selected dividing points, cancel each of them in reverse order (from the end of the movie to the beginning). In an order other than specified, you can neither select dividing points nor cancel the selections of the dividing points.

8 Select [Save to SD1] or [Save to SD2] and press **OK**.

When [Select single image] is selected, select [Continue] or [Exit], and press **OK**.

Caution

- Only RAW images captured with this camera can be developed.



Memo

- When [Select multiple images] or [Select a folder] is selected in Step 2, a folder with a new number is created, and the JPEG images are stored in it.
- For [Digital Filter], [HDR Capture], and [Pixel Shift Resolution], the setting of which parameters can be changed varies depending on the setting used during shooting. For the RAW images captured using [HDR Capture] or [Pixel Shift Resolution] of the **1** menu, the parameters of each setting can be changed. For other RAW images, the parameters of the [Digital Filter] setting can be changed.
- With the provided software "Digital Camera Utility 5", you can develop RAW files on a computer.

Camera Settings

Customizing the Button/E-dial Functions 4

Setting the E-dial Operation







For each exposure mode, you can set the functions for when  and  are turned and  is pressed.

- 1 Select [E-Dial Programming] in  4 menu and press .





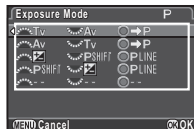

The [E-Dial Programming] screen appears.

- 2 Select an exposure mode and press .

The screen for the selected exposure mode appears.

- 3 Press  and use   to select the combination of functions for when  and  are turned and  is pressed.



 Tv	Change Shutter Speed
 Av	Change Aperture Value
ISO	Change Sensitivity
	EV Compensation
 P	Return to P Mode
 P SHIFT	Program Shift
 P LINE	Program Line
--	Not available



- 4 Press .

- 5 Press .



The [E-Dial Programming] screen reappears.
Repeat Steps 2 to 5.

- 6 Press  twice.

Memo

- If you select [Rotation Direction] in Step 2, you can reverse the effect obtained by turning  or .

Setting the Button Operation

You can set the functions for when  or  is pressed, or when the main switch is turned to .

- 1 Select [Button Customization] in  4 menu and press .

The [Button Customization] screen appears.

- 2 Select the desired item and press .

The screen to set the function for the selected item is displayed.

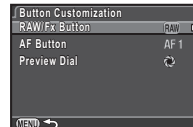

3 Press **▶** and use **▲▼** to select the functions to assign.

The following functions can be assigned to each button.

	Setting	Function	Page
RAW/Fx Button	One Push File Format	Temporarily changes the file format.	p.80
	Exposure Bracketing	Sets Exposure Bracketing.	p.52
	Optical Preview	Activates the Optical Preview function.	p.49
	Digital Preview	Activates the Digital Preview function.	
	Shake Reduction	Turns the Shake Reduction and Movie SR functions on/off.	–
	LCD Panel Illumination	Turns the LCD panel illumination on/off.	p.17
AF Button	Enable AF1	Autofocus is performed when AF is pressed.	p.46
	Enable AF2	Autofocus is performed when AF is pressed. Half press of the shutter release button is disabled.	
	Cancel AF	While AF is pressed, half press of the shutter release button is disabled.	
Preview Dial	Optical Preview	Activates the Optical Preview function.	p.49
	Digital Preview	Activates the Digital Preview function.	

4 Press **OK**.

5 Press **MENU**.

The screen of Step 2 reappears.

Repeat Steps 2 to 5.

6 Press **MENU** twice.

⚠ Caution

- [LCD Panel Illumination] in [RAW/Fx Button] cannot be selected when [21. LCD Panel Illumination] is set to [Off] in the **C3** menu.

Setting the One Push File Format

Select the file format to change to when **RAW/Fx** is pressed for each [File Format] setting.

1 Set [RAW/Fx Button] to [One Push File Format] in Step 3 of "Setting the Button Operation" (p.79).

2 Select or for [Cancel after 1 shot].

<input checked="" type="checkbox"/>	The recording format returns to the [File Format] setting of [Image Capture Settings] in the 1 menu after a picture is taken.
<input type="checkbox"/>	The setting is retained until any of the following operations is performed: <ul style="list-style-type: none"> • When RAW/Fx is pressed again • When OK, MENU, or INFO is pressed, or when the mode dial or main switch is turned

3 Select the file format when **RAW/Fx** is pressed.

The left side is the [File Format] setting and the right side is the changed file format when **RAW/Fx** is pressed.





⚠ Caution

- The One Push File Format function cannot be used when [Memory Card Options] in the 1 menu is set to [Separate RAW/JPEG]. (p.39)

Saving Frequently Used Settings

Camera settings can be saved to **U1**, **U2**, and **U3** of the mode dial and used repeatedly.

The following settings can be saved.

Exposure Mode (except for )	Drive Mode
Sensitivity	White Balance
EV Compensation	Custom Image
AE Metering	 1-4 menu settings (with exceptions)
AF point	C 1-4 menu settings
Flash Mode	

Saving the Settings

1 Set the exposure mode and all of the settings to save.

2 Select [Save USER Mode] in 4 menu and press **▶**.

The [Save USER Mode] screen appears.

3 Select [Save Settings] and press **▶**.

The [Save Settings] screen appears.



4 Select [USER1], [USER2], or [USER3], and press **▶**.

5 Select [Save] and press **OK**.

The screen of Step 3 reappears.

⚠ Caution

- [Save USER Mode] cannot be selected when the mode dial is set to .

📝 Memo

- The settings saved as the USER mode can be displayed on the monitor when you select [Check Saved Settings] in Step 3.
- To reset the settings to the default values, select [Reset USER Mode] in Step 3.

Editing a Setting Name

You can change the name of the USER mode in which you saved settings.

1 Select [Rename USER Mode] in Step 3 of "Saving the Settings" (p.81) and press **▶**.

The [Rename USER Mode] screen appears.

2 Select [USER1], [USER2], or [USER3], and press **▶**.

The text-entry screen appears.

3 Change the text.

Up to 18 single-byte alphanumeric characters and symbols can be entered.

Text selection cursor

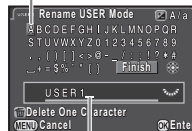

Text input cursor

Available operations

	Moves the text selection cursor.
	Moves the text input cursor.
	Switches between upper and lower case letters.
	Enters a character selected with the text selection cursor at the position of the text input cursor.
	Deletes a character at the position of the text input cursor.

4 After entering the text, move the text selection cursor to [Finish], and press .

The [Rename USER Mode] screen reappears.

Using the Saved USER Mode

1 Set the mode dial to U1, U2, or U3.

The USER mode guide is displayed for about 30 seconds. Use to check the saved settings.



2 Change the settings as necessary.

The exposure mode can be changed in [Exposure Mode] of the 1 menu.

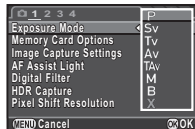

Memo

- The settings changed in Step 2 are not saved as the USER mode settings. When the camera is turned off, the camera returns to the originally saved settings. To change the original settings, save the USER mode settings again.

Displaying the Local Date and Time of the Specified City

1

The date and time set at the time of initial setting ("Initial Settings" (p.33)) serve as the date and time of your present location and are reflected in the shooting date and time for images.

Setting the destination to a location other than your present location enables you to display the local date and time on the monitor when traveling abroad and also save images time-stamped with the local date and time.

1 Select [World Time] in 1 menu.

The [World Time] screen appears.

2 Select the time you wish to display in [Time Setting].

(Hometown) or (Destination) can be selected.



3 Select [Destination] and press .

The [Destination] screen appears.

4 Use to select a city.

Use to change the region.

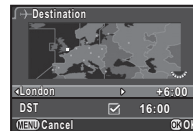

5 Select [DST] (daylight saving time), and use to select or .

6 Press .

The screen of Step 2 reappears.

7 Press twice.

Memo

- Refer to “List of World Time Cities” (p.100) for cities that can be selected as a hometown or destination.
- Select [Hometown] in Step 3 to change the city and DST settings for the hometown.
- appears in the control panel when [Time Setting] is set to .

Selecting Settings to Save in the Camera 4

Most of the functions set on this camera are saved even if the camera is turned off. For the following function settings, you can select whether to save the settings () or to return the settings to their default values () when the camera is turned off. Set in [Memory] of the 4 menu.

Flash Mode	Flash Exposure
Drive Mode	Compensation
White Balance	Digital Filter
Custom Image	HDR Capture
Sensitivity	Pixel Shift Resolution
EV Compensation	Composition Adjustment
	Playback Info Display

Memo

- When [Reset] of the 3 menu is performed, all Memory settings return to the default values.

File Management Settings

Protecting Images from Deletion (Protect)

You can protect images from being accidentally deleted.

Caution

- Even protected images are deleted if the inserted memory card is formatted.

1 Select in the playback mode palette.

The screen for selecting the unit for processing appears.

2 Select [Select image(s)] or [Select a folder] and press .



3 Select the image(s) or folder to protect.

Refer to Step 2 of “Deleting Selected Images” (p.68) for how to select the image(s).

Proceed to Step 5 if [Select a folder] is selected.

4 Press .

The confirmation screen appears.

5 Select [Protect] and press .

Memo

- To protect all images stored in the memory card, select [Protect All Images] of the 1 menu.

Selecting the Folder/File Settings



Folder Name

When images are captured with this camera, a folder is automatically created and the captured images are stored in it. Each folder name consists of a sequential number from 100 to 999 and a string of 5 characters. The folder name can be changed.

1 Select [Folder Name] in menu and press .

The [Folder Name] screen appears.

2 Select a folder name and press .

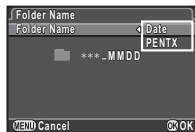

Date	The four digits of the month and day on which the picture was taken are assigned after the folder number. The month and day appear according to the date format set in [Date Adjustment]. Example) 101_0125: for images taken on January 25th
PENTX	The character string "PENTX" is assigned after the folder number. The character string can be changed. Example) 101PENTX

Proceed to Step 6 if you selected [Date] or do not need to change the character string from "PENTX".

3 Press , and then press .

The text-entry screen appears.

4 Change the text.

Enter 5 single-byte alphanumeric characters.

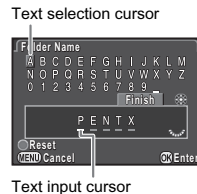

Available operations



Moves the text selection cursor.



Moves the text input cursor.



Enters a character selected with the text selection cursor at the position of the text input cursor.



Resets the entered text to "PENTX".

5 After entering the text, move the text selection cursor to [Finish], and press .

The screen of Step 2 reappears.

6 Press twice.

Memo

- A folder with a new number is created when the folder name is changed.
- A maximum of 500 images (100 images for Eye-Fi card) can be stored in a single folder. When the number of captured images exceeds 500, a new folder is created with the number following the number of the folder currently being used. In Exposure Bracketing shooting, images are stored in the same folder until shooting is completed.

Caution

- The maximum folder number is 999. After the folder number reaches 999, you cannot capture new images if you attempt to change the folder name or create a new folder, or when the file name number reaches 9999.

Create New Folder

When [Create New Folder] is selected in the **2** menu, a folder is created with a new number when the next image is saved.

⚠ Caution

- You cannot successively create multiple folders.

📝 Memo

- When a memory card is inserted in both the SD1 and the SD2 slots, a new folder is created on both memory cards.
- A new folder is automatically created in the following cases.
 - When the drive mode is set to [Interval Shooting] (p.54)
 - When the drive mode is set to [Interval Composite] and [Save Process] is set to (On) (p.54)
 - When [Select multiple images] or [Select a folder] is selected for [RAW Development] of the playback mode palette (p.77)

File Name

One of the following string of characters is used as the file name prefix depending on the [20. Color Space] setting of the **C3** menu.

Color Space	File Name
sRGB	IMGP*****.JPG
AdobeRGB	IMG*****.JPG

The first four characters can be changed to a character string of your choice.

1 Select [File Name] in **2** menu and press **▶**.

The [File Name] screen appears.

2 Select **📁** or **📂**, and press **▶**.

The text-entry screen appears.

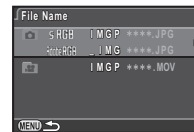

3 Change the text.

Up to 4 single-byte alphanumeric characters can be entered as an alternative for the first part of the file name, while the asterisks stand for figures that increase automatically shot by shot.

Refer to Steps 4 and 5 of “Folder Name” (p.84) for how to enter text.

4 Press **MENU** twice.

📝 Memo

- When [Color Space] is [AdobeRGB], the file name prefix is “_” and first three characters of the entered character string becomes the file name.
- For movies, regardless of the [Color Space] setting, the file name is “IMG P ****.MOV” or the one with the entered string of characters.

File No.

Each file name consists of a string of 4 characters and a sequential number from 0001 to 9999.

You can set whether to continue the sequential numbering for the file name even if a new folder is created in [Sequential Numbering] of [File No.] in the **↖2** menu.

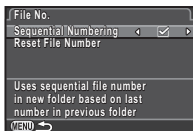

<input checked="" type="checkbox"/>	Continues the sequential numbering for the file name even if a new folder is created.
<input type="checkbox"/>	Returns the file number of the first image saved to a folder to 0001 each time a new folder is created.

Select [Reset File Number] to reset the file number to its default value.

Memo

- When the file number reaches 9999, a new folder is created and the file number is reset.

Setting the Copyright Information

Sets the photographer and copyright information embedded in the Exif data.

1 Select [Copyright Information] in **↖2 menu and press **▶**.**

The [Copyright Information] screen appears.

2 Use **◀▶ to set [Embed Copyright Data].**

<input type="checkbox"/>	Does not embed copyright information in the Exif data.
<input checked="" type="checkbox"/>	Embeds copyright information in the Exif data.

3 Select [Photographer] or [Copyright Holder], and press **▶.**

The text-entry screen appears.

4 Change the text.

Up to 32 single-byte alphanumeric characters and symbols can be entered.

Refer to Steps 3 and 4 of "Editing a Setting Name" (p.81) for how to enter text.

5 Press **MENU twice.****Memo**

- The Exif information can be checked using the provided software "Digital Camera Utility 5".

Using a Wireless Memory Card

A memory card with a built-in wireless LAN (Wi-Fi) "Eye-Fi card" or a "Flucard" compatible with this camera can be used.

By using these cards, images can be transferred from the camera to a computer or other device via wireless LAN. You can set the camera action for when an Eye-Fi card or a Flucard is used.

1 Select [Wireless Memory Card] in **↖3 menu and press **▶**.**

The [Wireless Memory Card] screen appears.

2 Select [Action Mode].

Items that can be set are displayed according to the type of card inserted.

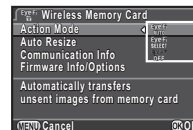

Eye-Fi card

AUTO	Transfers automatically when images are taken, new images are saved, or images are overwritten. For movies, only files of 2 GB or less can be transferred.
SELECT	Transfers images or folders that are selected in [Eye-Fi Image Transfer] of the playback mode. Only JPEG and RAW images can be transferred.
OFF	Stops the communication function.

Flucard

ON	Enables wireless data transfer with Flucard.
OFF	Disables wireless data transfer with Flucard.

3 Specify [Auto Resize].

When set to , JPEG images are saved to the Eye-Fi card or Flucard with the size of .

4 Press **MENU** twice.

⚠ Caution

- Insert an Eye-Fi card or a Flucard in the SD2 slot. If it is inserted in the SD1 slot, the wireless LAN function cannot be used. When an Eye-Fi card or a Flucard is not inserted in the SD2 slot, the [Wireless Memory Card] settings cannot be set.
- Set up a wireless LAN access point on a computer for the card connection.
- For RAW images and movie files, the success of transfer depends on the specifications and settings of the Eye-Fi card in use. GPS log files cannot be transferred.
- Images may not be transferred when the battery level is low.
- It may take time to transfer a large number of images. The camera may turn off if the internal temperature of the camera becomes high.
- For precautions on the Eye-Fi card, refer to "About Eye-Fi Cards" (p.108).

📄 Memo

- A smartphone can be used to operate the camera when a Flucard compatible with this camera is used. Refer to the Flucard manual for details on how to use the card.
- When an Eye-Fi card is used, 100 images can be stored in a single folder. For RAW+ images, two files are counted as one image.
- In Step 2, select [Communication Info] to check the wireless LAN information, and [Firmware Info/Options] to check the firmware version of the card.
- When [Reset Transfer Settings] is selected in Step 2, the [Action Mode] setting is returned to the default value.

Restrictions on the Combinations of Special Functions

#: Restricted x: Not available

	Digital Filter	HDR Capture	Pixel Shift Resolution	Distortion Correction	ASTRO-TRACER	Composition Adjust.	AA Filter Simulator	Save RAW Data
Flash		x	x					
Drive Mode	Continuous Shooting		x		x		#*2	x
	Exposure Bracketing		x		x		#*2	
	Mirror Lock-up Shooting		x			x	#*2	
	Multi-exposure	x	x	x	x		#*2	
	Interval Shooting	#*1	#*1	x		x	#*2	
	Interval Composite	x	x	x	x	x	#*2	
	Interval Movie Record	#*1	#*1	x		x	x	x
HDR Capture	x		x		x		x	
Pixel Shift Resolution	x	x			x		x	
AA Filter Simulator		x	x					

*1 There is a restriction on the minimum value for [Interval].

*2 [Bracketing] is not available.

Functions Available with Various Lenses

All capture modes are available when a DA, DA L, or FA J lens is used, or when a lens with an **A** position is used with the aperture ring set to the **A** position.

When other lenses than above are used, or a lens with **A** position is used in a position other than **A**, the following restrictions apply.

✓ : Available # : Restricted ✗ : Not available

Function	Lens [Mount type]					
	DA DA L D FA	FA J FA *6	F *6	A	M P	
	[KAF] [KAF2] [KAF3]	[KAF] [KAF2]	[KAF]	[KA]	[K]	
Autofocus (Lens only) (With AF adapter 1.7x) ^{*1}	✓ -	✓ -	✓ -	- #	- #	
Manual focus (With focus indicator) ^{*2} (With matte field)	✓	✓	✓	✓	✓	
Quick-shift focus	# ^{*4}	✗	✗	✗	✗	
Focus point selection mode [Auto]	✓	✓	✓	# ^{*8}	✗	
AE Metering [Multi-segment]	✓	✓	✓	✓	✗	
P/Sv/Tv/Av/TA v mode	✓	✓	✓	✓	# ^{*9}	
M mode	✓	✓	✓	✓	#	
P-TTL auto flash ^{*3}	✓	✓	✓	✓	✗	
Power zoom	-	✗	-	-	-	
Automatic obtaining of the lens focal length information	✓	✓	✓	✗	✗	
Lens Correction	✓ ^{*5}	✗ ^{*7}	✗	✗	✗	

- *1 Lenses with a maximum aperture of F2.8 or faster. Only available at the **A** position.
- *2 Lenses with a maximum aperture of F5.6 or faster.
- *3 Available when using AF540FGZ, AF540FGZ II, AF360FGZ, AF360FGZ II, AF201FG, AF200FG, or AF160FC.
- *4 Only available with compatible lenses.
- *5 Distortion Correction and Peripheral Illumination Correction are disabled when a DA FISH-EYE 10-17mm lens is used.
- *6 To use an FA SOFT 28mm F2.8 lens, FA SOFT 85mm F2.8 lens, or F SOFT 85mm F2.8 lens, set [26. Using Aperture Ring] to [Enable] in the **C4** menu. Pictures can be taken with the aperture you set, but only within a manual aperture range.
- *7 Only available with an FA 31mm F1.8 Limited, FA 43mm F1.9 Limited, or FA 77mm F1.8 Limited lens.
- *8 Fixed to [Spot].
- *9 **Av** with the aperture set to wide open. (The aperture ring has no effect on the actual aperture value.)

⚠ Caution

- When the aperture ring is set to a position other than **A** or a lens without an **A** position or accessories such as an auto extension tube or auto bellows are used, the camera does not operate unless [26. Using Aperture Ring] is set to [Enable] in the **C4** menu. Refer to "Using the Aperture Ring" (p.90) for details.
- When a retractable lens is attached and is not extended, you cannot take pictures or use some functions. If the lens is retracted during shooting, the camera stops working.

Lens Names and Mount Names

DA lenses with a motor and FA zoom lenses with a power zoom use the KAF₂ mount. (Of these lenses, the lenses without an AF coupler use the KAF₃ mount.)
FA single focal length lenses (non-zoom lenses), DA and DA L lenses without a motor, and D FA, FA J, and F lenses use the KAF mount.
Refer to respective lens manuals for details.

Using the Aperture Ring

C4

The shutter can be released even if the aperture ring of the D FA, FA, F, or A lens is not set to the **A** position or a lens without an **A** position is attached.

Select [Enable] in [26. Using Aperture Ring] of the **C4** menu.

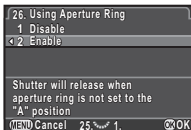

The following restrictions apply depending on the lens being used.

Lens	Exposure Mode	Restriction
D FA, FA, F, A, M (lens only or with automatic diaphragm accessories such as auto extension tube K)	Av	The aperture remains open. The shutter speed changes in relation to the open aperture but an exposure deviation may occur.
D FA, FA, F, A, M, S (with diaphragm accessories such as extension tube K)	Av	Pictures can be taken with the set aperture value but an exposure deviation may occur.
Manual diaphragm lens such as reflex lens (lens only)	Av	
FA SOFT 28mm/ FA SOFT 85mm/ F SOFT 85mm (lens only)	Av	Pictures can be taken with the set aperture value in the manual aperture range.

Memo

- If the aperture ring is set to a position other than **A**, the camera operates in **Av** mode regardless of the mode dial setting except when set to **M**, **B**, or **X** mode.

- [F--] appears for the aperture indicator in the status screen, Live View screen and viewfinder and on the LCD panel.

How to Achieve the Correct Exposure with the Aperture Ring Not Set to A

The correct exposure can be achieved by the following procedures when the aperture ring is not set to **A**.

- Set the mode dial to **M**.
- Set the aperture ring to the desired aperture.
- Press **○**.
The correct shutter speed will be set.
- If the correct exposure cannot be achieved, adjust the ISO sensitivity.

Setting the Focal Length



The Shake Reduction function operates by obtaining the lens information such as focal length. Set the focal length when using a lens that the focal length information cannot be automatically obtained.

- 1 Set [26. Using Aperture Ring] to [Enable] in the C4 menu.**
- 2 Turn the camera off.**
- 3 Attach a lens to the camera and turn the camera on.**
The [Input Focal Length] screen appears.

- 4 Use ▲▼ to set the focal length.**

Press ◀ to select a value from the list.

When using a zoom lens, select the actual focal length which the zoom is set to.

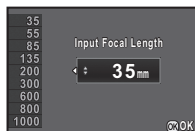

- 5 Press OK.**

The camera returns to standby mode.

Memo

- The focal length setting can be changed in [Input Focal Length] of the 3 menu.

Functions when Using an External Flash

Use of the following external flashes (optional) enables a variety of flash modes, such as P-TTL auto flash mode.

✓: Available #: Restricted X: Not available

Camera Function \ Compatible Flash	AF540FGZ AF540FGZ II AF360FGZ AF360FGZ II	AF201FG AF200FG AF160FC
Red-eye reduction flash	✓	✓
Auto Flash Discharge	✓*1	✓*1
Automatic switch to the flash sync speed	✓	✓
Automatic setting of the aperture value in P or Tv mode	✓*1	✓*1
P-TTL auto flash	✓*1	✓*1
Slow-speed Sync flash	✓	✓
Flash Exposure Compensation	✓	✓
AF assist light of the external flash	✓*2	X
Trailing Curtain Sync flash*3	✓	#*4
Contrast-control-sync flash	✓*5	#*6
Slave flash	✓*5	X
High-speed Sync flash	✓	X
Wireless flash	✓*5	X

*1 Available only when using a DA, DA L, D FA, FA J, FA, F, or A lens.

*2 AF assist light is not available with the AF540FGZ or AF360FGZ.

*3 Shutter speed of 1/90 seconds or slower.

*4 Not available with the AF200FG or AF160FC.

*5 Multiple AF540FGZ, AF540FGZ II, AF360FGZ, or AF360FGZ II units are required.

*6 Available only when combined with the AF540FGZ, AF540FGZ II, AF360FGZ, or AF360FGZ II.

⚠ Caution

- Flashes with the reversed polarity (the center contact on the hot shoe is minus) cannot be used due to the risk of damaging the camera and/or flash.
- Do not combine with accessories that have a different number of contacts, such as Hot Shoe Grip, as a malfunction may occur.
- Combining with flashes from other manufacturers may cause equipment breakdown.

📌 Memo

- With the AF540FGZ, AF540FGZ II, AF360FGZ, or AF360FGZ II, you can use the high-speed sync flash to discharge the flash and take a picture at a shutter speed faster than 1/180 seconds. Set the exposure mode to **Tv**, **TAv**, or **M**.
- By using two or more external flashes (AF540FGZ, AF540FGZ II, AF360FGZ, or AF360FGZ II), you can use the wireless mode to shoot in P-TTL flash mode without connecting the flash units with a cord. In this case, set the camera channel on the external flashes.
- You can connect an external flash to the camera with a sync cord by using the X-sync socket. Remove the Sync socket 2P cap to connect a sync cord to the X-sync socket.

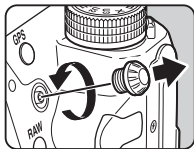













Troubleshooting

📌 Memo

- In rare cases, the camera may not operate correctly due to causes such as static electricity, etc. This can be remedied by taking the battery out and putting it back in again. If the camera operates correctly, it does not require any repairs.

Problem	Cause	Remedy
The camera does not turn on.	The battery is not installed properly.	Check the orientation of the battery.
	The battery power is low.	Charge the battery.
The shutter cannot be released.	There is no available space on the memory card.	Insert a memory card with available space or delete unwanted images.
	Data is being processed.	Wait until processing is finished.
	The lens aperture ring is set to a position other than A .	Set the lens aperture ring to the A position or select [Enable] in [26. Using Aperture Ring] of the C4 menu. (p.90)
	The autofocus mode is set to AF.S or AF.A and the subject is not in focus.	Set the focus method to MF and adjust focus manually.
Autofocus does not work.	The subject is difficult to focus on.	AF cannot work well for low-contrast objects (the sky, white walls, etc.), dark colors, intricate designs, rapidly-moving objects or scenery shot through a window or a net-like pattern. Lock focus on another object located at the same distance as your subject, then aim at the target and take a picture. Alternatively, use MF .
	The subject is too close.	Move away from the subject and take a picture.

Problem	Cause	Remedy
The focus cannot be locked.	The autofocus mode of Live View is set to  .	Set [Contrast AF] to  ,  ,  , or  . (p.48)
The flash does not discharge.	The flash mode is set to  or  .	When the flash mode is set to  or  , the flash does not discharge if the subject is bright. Change the flash mode. (p.45)
The camera is not recognized when it is connected to a computer.	The USB connection mode is set to [PTP].	Set [USB Connection] to [MSC] in the  menu.
Dust or dirt particles appear in images.	The CMOS sensor is dirty or dusty.	Activate [Dust Removal] from the  menu. The Dust Removal function can be activated every time the camera is turned on and off. Refer to "Sensor Cleaning" (p.93) if the problem persists.
Pixel defects such as bright spots and dark spots appear in the image.	There are defective pixels in the CMOS sensor.	Activate [Pixel Mapping] from the  menu. It takes about 30 seconds to correct the defective pixels, so be sure to install a fully charged battery.

Sensor Cleaning

Detecting Dust on the CMOS Sensor (Dust Alert)

Dust Alert is the function that detects dust adhering to the CMOS sensor and visually displays the location of the dust. Before cleaning the sensor, ensure that the following conditions are met.

- Attach a DA, DA L, FA J lens or a D FA, FA or F lens that has an **A** position, and set the aperture ring to the **A** position.
- Turn the capture mode selector switch to .
- Set the focus mode switch to **AF**.

1 Select [Dust Alert] in menu and press .

The [Dust Alert] screen appears.

2 Fully display a white wall or other bright subject with no detail in the viewfinder and press the shutter release button fully.

After image processing is performed, the Dust Alert image appears.

If [The operation could not be completed correctly] appears, press  and take another picture.

3 Check the sensor for dust.

Use  to display the Dust Alert image at full screen display.



4 Press .

The Dust Alert image is saved and the  menu reappears.

Memo

- Only the latest Dust Alert image is saved to the SD1 slot memory card for approximately 30 minutes. If Sensor Cleaning is performed during this 30 minutes, the Dust Alert image can be checked while cleaning the sensor. (If the SD1 slot is disabled, the image is not saved. You cannot check the image in playback mode.)

Removing Dust with a Blower

Raise the mirror up and open the shutter when cleaning the CMOS sensor with a blower.

- 1 Turn the camera off and remove the lens.**
- 2 Turn the camera on.**
- 3 Select [Sensor Cleaning] in \curvearrowright 4 menu and press \blacktriangleright .**
The [Sensor Cleaning] screen appears.
- 4 Select [Mirror Up] and press OK .**
The mirror rises up.
If a Dust Alert image is saved, it appears.
- 5 Clean the CMOS sensor with a blower.**
- 6 Turn the camera off.**
The mirror automatically returns to its original position.

Caution

- Never use a spray blower or a blower with a brush.
The CMOS sensor may be damaged. Do not wipe the CMOS sensor with a cloth.
- Do not put the tip of the blower inside the lens mount area.
If the power is turned off during cleaning, this may cause damage to the shutter, CMOS sensor and the mirror. Hold the camera with the lens mount down while cleaning the sensor so dust will fall away from the sensor when the blower is used.
- When the battery level is low, the message [Not enough battery power remaining to clean sensor] is displayed on the monitor. Install a fully charged battery. If the battery capacity becomes low during cleaning, a warning beep will sound. In this case, stop cleaning immediately.

Memo

- Please contact your nearest service center for professional cleaning as the CMOS sensor is a precision part.
- You can use the optional Image Sensor Cleaning Kit O-ICK1 when cleaning the CMOS sensor.

Error Messages

Error Messages	Description
Memory card full	The memory card is full and no more images can be saved. Insert a new memory card or delete unwanted files.
No image	There are no images that can be played back on the memory card.
This image cannot be displayed	You are trying to play back an image in a format not supported by this camera. You may be able to play it back on a computer.
No card in the camera	There is no memory card inserted in the camera.
Memory card error	The memory card has a problem, and image capture and playback are impossible. You may be able to play back or recover the images on a computer.
	Failed to initialize the Eye-Fi function when using an Eye-Fi card. Press OK .
Card is not formatted	The memory card you have inserted is unformatted or has been previously used on another device and is not compatible with this camera. Use the card after formatting it with this camera.
Card is locked	The write-protect switch on the memory card you have inserted is locked. (p.108)
This image cannot be magnified	You are trying to magnify an image that cannot be magnified.
This image is protected	You are trying to delete an image that is protected. Remove the protection from the image. (p.83)

Error Messages	Description
Not enough battery power remaining to activate Pixel Mapping	These messages appear when you try to perform Pixel Mapping or Sensor Cleaning, or to update the firmware if the battery level is insufficient. Install a fully charged battery.
Not enough battery power remaining to clean sensor	
Not enough battery power remaining to update the firmware	
Unable to update firmware. There is a problem with the firmware update file	Unable to update the firmware. The update file is damaged. Try downloading the update file again.
Image folder cannot be created	The maximum folder number (999) is being used, and no more images can be saved. Insert a new memory card or format the card.
Unable to store image	The image could not be saved because of a memory card error.
The operation could not be completed correctly	The operation failed. Try the operation again.
No more images can be selected	You are trying to select more than the maximum number of images for the following functions. <ul style="list-style-type: none"> • Select & Delete • Image Copy • Index • RAW Development • Protect • Eye-Fi Image Transfer
No image can be processed	There are no images that can be processed using the Digital Filter or RAW Development function.
This image cannot be processed	Appears when you try to perform Resize, Cropping, Digital Filter, Movie Edit, RAW Development, or Save as Manual WB for images captured with other cameras, or when you try to perform Resize or Cropping for minimum file size images.
The camera failed to create an image	Failed to create an index print image.

Error Messages	Description
This function is not available in the current mode	You are trying to set a function that is not available for the exposure mode that is set.
The camera will turn off to prevent damage from overheating	The camera will turn off because its internal temperature is too high. Leave the camera turned off until it has had time to cool down before turning on the camera again.
Set the Eye-Fi communication to "SELECT"	Images cannot be transferred when [Action Mode] is not set to [SELECT] in [Wireless Memory Card] of the  3 menu. (p.86)
Image not found	There are no images that can be transferred when an Eye-Fi card is used.
Cannot be selected	This folder cannot be selected because the number of files exceeds the maximum number allowed.
Shutter release is disabled. Ensure the zooming index on the lens is set to a position that permits shutter release	Pictures cannot be taken when a retractable lens is attached and is not extended. (p.37)

Main Specifications

Model Description

Type	TTL autofocus, auto-exposure SLR digital camera
Lens Mount	PENTAX KAF2 bayonet mount (AF coupler, lens information contacts, K-mount with power contacts)
Compatible Lenses	KAF3, KAF2 (power zoom compatible), KAF, KA mount lenses

Image Capture Unit

Image Sensor	Primary color filter, CMOS, Size: 23.5 × 15.6 (mm)
Effective Pixels	Approx. 24.35 megapixels
Total Pixels	Approx. 24.71 megapixels
Dust Removal	Image sensor cleaning using ultrasonic vibrations "DR II" with the Dust Alert function
Sensitivity (Standard Output)	ISO AUTO, Manual ISO range: 100 to 51200 EV steps can be set to 1 EV, 1/2 EV, or 1/3 EV
Image Stabilizer	Sensor-shift Shake Reduction
AA Filter Simulator	Moiré reduction using SR unit: OFF, Type1, Type2, Bracketing

File Formats

Recording Formats	RAW (PEF/DNG), JPEG (Exif 2.30 compliant), DCF 2.0 compliant
Recorded Pixels	JPEG: \square (24M: 6016×4000), \mathbb{M} (14M: 4608×3072), \mathbb{S} (6M: 3072×2048), $\times\mathbb{S}$ (2M: 1920×1280) RAW: \square (24M: 6016×4000)
Quality Level	RAW (14bit): PEF, DNG JPEG: ★★★ (Best), ★★ (Better), ★ (Good) RAW + JPEG simultaneously recordable
Color Space	sRGB, AdobeRGB
Storage Media	SD/SDHC*/SDXC* memory card, Eye-Fi card, Flucard (*UHS-I compatible)
Dual Card Slots	Sequential Use, Save to Both, Separate RAW/JPEG, Copying images between slots possible

Storage Folder	Folder Name: Date (100_1018, 101_1019...) or a user-assigned name (default: PENTX)
Storage File	File Name: user-assigned name (default: IMG*****) File No.: Sequential Numbering, Reset

Viewfinder

Type	Pentaprism Finder
Coverage (FOV)	Approx. 100%
Magnification	Approx. 0.95× (50mm F1.4 at infinity)
Eye-Relief Length	Approx. 20.5 mm (from the view window) Approx. 22.3 mm (from the center of lens)
Diopter Adjustment	Approx. -2.5 to +1.5 m ⁻¹
Focusing Screen	Interchangeable Natural-Bright-Matte III focusing screen

Live View

Type	TTL method using the CMOS image sensor
Focusing System	Contrast detection (Face Detection, Tracking, Multiple AF Points, Select, Spot) Focus Peaking: ON/OFF
Display	Field of view: approx. 100%, Electronic Level Display, Magnified view (up to 10×), Grid Display (4 × 4 Grid, Golden Section, Scale), Histogram, Highlight Alert, Composition Adjustment

LCD Monitor

Type	Wide viewing angle TFT color LCD with an AR coating and air-gapless tempered glass
Size	3.2 inches (aspect ratio 3:2)
Dots	Approx. 1037K dots
Adjustment	Brightness, saturation and colors adjustable

White Balance

Type	Method using a combination of the CMOS image sensor and the light source detection sensor
Preset Modes	Auto White Balance, Multi Auto White Balance, Daylight, Shade, Cloudy, Fluorescent Light (D: Daylight Color, N: Daylight White, W: Cool White, L: Warm White), Tungsten Light, Flash, CTE, Manual White Balance (up to 3 settings), Color Temperature (up to 3 settings), Copying the white balance settings of a captured image
Fine Adjustment	Adjustable ± 7 steps on A-B axis and G-M axis

Autofocus System

Type	TTL phase-matching autofocus
Focus Sensor	SAFOX 11, 27 points (25 cross type focus points in the center)
Brightness Range	EV -3 to 18 (ISO100, at normal temperature)
AF Modes	Single AF (A.F.S.), Continuous AF (A.F.C.), Auto select AF (A.F.A.)
Focus Point Selection Modes	Spot, Select, Expanded Area AF (S, M, L), Zone Select, Auto (27 AF Points)
AF Assist Light	Dedicated LED AF assist light

Exposure Control

Type	TTL open-aperture metering using 86K pixel RGB sensor Metering modes: Multi-segment, Center-weighted, Spot
Metering Range	EV -3 to 20 (ISO100 at 50mm F1.4)
Exposure Modes	Green Mode, Program, Sensitivity Priority, Shutter Priority, Aperture Priority, Shutter & Aperture Priority, Manual, Bulb, Flash X-sync Speed, USER1, USER2, USER3
EV Compensation	± 5 EV (1/3 EV steps or 1/2 EV steps can be selected)
AE Lock	Button type (timer-control: two times the meter operating time set in Custom Setting); continues as long as the shutter button is halfway pressed.

Shutter

Type	Electronically controlled vertical-run focal plane shutter • Electronic shutter is used for Pixel Shift Resolution
Shutter Speed	Auto: 1/8000 to 30 seconds, Manual: 1/8000 to 30 seconds (1/3 EV steps or 1/2 EV steps), Bulb

Drive Modes

Mode Selection	[Still picture] Single frame, Continuous (H, M, L), Self-timer (12 sec., 2 sec.), Remote Control (immediately, 3 sec., continuous), Exposure Bracketing (2, 3, or 5 frames; available with Self-timer or Remote Control), Mirror Lock-up Shooting (available with Remote Control), Multi-exposure (available with Continuous Shooting, Self-timer, or Remote Control), Interval Shooting, Interval Composite [Movie] Remote Control, Interval Movie Record
Continuous Shooting	Max. approx. 8.3 fps, JPEG ([L]: ★★★ at Continuous H); up to approx. 60 frames, RAW: up to approx. 23 frames Max. approx. 4.5 fps, JPEG ([L]: ★★★ at Continuous M); up to approx. 100 frames, RAW: up to approx. 32 frames Max. approx. 3.0 fps, JPEG ([L]: ★★★ at Continuous L); up to approx. 200 frames, RAW: up to approx. 52 frames • When the sensitivity is set to ISO100
Multi-exposure	Composite Mode: Additive, Average, Bright Number of Shots: 2 to 2000 times
Interval Shooting	[Still picture] Interval: 2 sec. to 24 hr., Number of shots: 2 to 2000 times, Start Interval: Now, Set Time [Movie] Recorded Pixels: [4K], [FullHD], [HD], Interval: 2 sec. to 1 hr., Recording Time: 14 sec. to 99 hr., Start Interval: Now, Set Time



External Flash

Flash Modes	Auto Flash Discharge, Auto Flash + Red-eye Reduction, Flash On, Flash On + Red-eye Reduction, Slow-speed Sync, Slow-speed Sync + Red-eye, P-TTL, Trailing Curtain Sync, Contrast-control-sync, High-speed Sync, Wireless Sync • Available with dedicated external flash units
Sync Speed	1/180 seconds
Flash Exposure Compensation	-2.0 to +1.0 EV

Capture Functions

Custom Image	Bright, Natural, Portrait, Landscape, Vibrant, Radiant, Muted, Bleach Bypass, Reversal Film, Monochrome, Cross Processing
Cross Processing	Random, Preset 1-3, Favorite 1-3
Digital Filter	Extract Color, Toy Camera, Retro, High Contrast, Shading, Invert Color, Unicolor Bold, Bold Monochrome
HDR Capture	Auto, Type1, Type2, Type3 Bracket Value adjustable Auto Align: On, Off
Pixel Shift Resolution	On, Off
Lens Correction	Distortion Correction, Peripheral Illumination Correction, Lateral Chromatic Aberration Correction, Diffraction Correction
D-Range Settings	Highlight Correction, Shadow Correction
Noise Reduction	Slow Shutter Speed NR, High-ISO NR
GPS	GPS Logging (Logging Interval, Logging Duration, Memory Card Options), ASTROTRACER, Calibration, Additional Settings (GPS Time Sync, GPS Indicator Lamp)
Horizon Correction	SR On: corrects up to 1 degree SR Off: corrects up to 2 degrees
Composition Adjustment	Adjustment range of ± 1.5 mm up, down, left or right (± 1 mm when rotated); rotating range of ± 1 degree
Electronic Level	Displayed in viewfinder and LCD panel (horizontal direction only); displayed on monitor (horizontal direction and vertical direction)

Movie

Recording Format	MPEG-4 AVC/H.264 (MOV) • Motion JPEG (AVI) for Interval Movie Record
Recorded Pixels	 (1920x1080, 60i/50i/30p/25p/24p)  (1280x720, 60p/50p/30p/25p/24p)
Sound	Built-in monaural microphone, external microphone (stereo recording compatible) Recording Sound Level adjustable
Recording Time	Up to 4 GB or 25 minutes; automatically stops recording if the internal temperature of the camera becomes high.
Custom Image	Bright, Natural, Portrait, Landscape, Vibrant, Radiant, Muted, Bleach Bypass, Reversal Film, Monochrome, Cross Processing
Cross Processing	Random, Preset 1-3, Favorite 1-3
Digital Filter	Extract Color, Toy Camera, Retro, High Contrast, Shading, Invert Color, Unicolor Bold, Bold Monochrome
HDR Capture • Available only for Interval Movie Record	Auto, Type1, Type2, Type3 Bracket Value adjustable

Playback Functions

Playback View	Single image, Multi-image display (6, 12, 20, 35, and 80 thumbnails), Image magnification (Up to 16x, 100% display, and quick zoom), Rotated image display, Histogram (Y histogram, RGB histogram), Highlight Alert, Auto Screen Rotation, Detailed Information Display, Copyright Information (Photographer, Copyright Holder), Folder Display, Calendar Filmslip Display, Slideshow, GPS information (Latitude, Longitude, Altitude, Coordinated Universal Time (UTC)), Direction
Delete	Single image, all images, select & delete, folder, Instant Review image
Digital Filter	Base Parameter Adj, Extract Color, Toy Camera, Retro, High Contrast, Shading, Invert Color, Unicolor Bold, Bold Monochrome, Tone Expansion, Sketch, Water Color, Pastel, Posterization, Miniature, Soft, Starburst, Fish-eye, Slim

RAW Development	Development options: Select single image, Select multiple images, Select a folder Development parameters: File Format (JPEG, TIFF), Aspect Ratio, JPEG Recorded Pixels, JPEG Quality, Color Space, Distortion Correction, Peripheral Illumin. Corr., Lat-Chromatic-Ab Adj, Diffraction Correction, Color Fringe Correction, White Balance, Custom Image, Digital Filter, HDR Capture, Pixel Shift Resolution, Sensitivity, High-ISO NR, Shadow Correction
Editing Features	Color Moiré Correction, Resize, Cropping (aspect ratio can be changed and tilt correction is available), Index, Movie Edit (dividing a movie file and deleting unwanted segments), Capturing a JPEG still picture from a movie, Save RAW Data, Image Copy, Eye-Fi Image Transfer

Customization

USER Mode	Up to 3 settings can be saved.
Custom Functions	26 items
Mode Memory	12 items
E-Dial Programming	E-dials (front/rear): customizable to each exposure mode
Button Customization	Fn button: One Push File Format, Exposure Bracketing, Optical Preview, Digital Preview, Shake Reduction, LCD Panel Illumination AF button: Enable AF1, Enable AF2, Cancel AF
AF Customization	AF.S Setting: Focus-priority, Release-priority 1st Frame Action in AF.C: Release-priority, Auto, Focus-priority Action in AF.C Continuous: Focus-priority, Auto, FPS-priority Hold AF Status: Off, Low, Medium, High AF in Interval Shooting: Locks focus at 1st exposure, Adjusts focus for each shot
Text Size	Standard, Large
World Time	World Time settings for 75 cities (28 time zones)
AF Fine Adjustment	±10 steps, adjustment for all lenses or individual lenses (up to 20 values can be saved)
Copyright Information	Names of "Photographer" and "Copyright Holder" are embedded to the image file. A revision history can be checked using the provided software.

GPS/Electronic Compass

Satellite Systems	GPS, QZSS SBAS: WAAS, EGNOS, GAGAN, MSAS
Reception Frequency	L1, 1575.42 MHz
Recorded Information	Latitude, Longitude, Altitude, Coordinated Universal Time (UTC), Direction
Geodesics	World Geodetic System (WGS84)
GPS Logging	KML format, Logging Interval: 5sec., 10sec., 15sec., 30sec., or 1min. Logging Duration: 1hr. to 24hr. (Up to 9 hours when Logging Interval is set to "5sec." Up to 18 hours when Logging Interval is set to "10sec.")
Electronic Compass	Azimuth calculation using triaxial geomagnetic sensor and triaxial acceleration sensor, True north standard

Power Supply

Battery Type	Rechargeable Lithium-ion Battery D-LI90
AC Adapter	AC Adapter Kit K-AC132 (optional)
Battery Life	Number of recordable images: approx. 720 images Playback time: approx. 370 minutes • Tested in compliance with CIPA standard using a fully charged lithium-ion battery at a temperature of 23°C. Actual results may vary depending on the shooting conditions/circumstances.

Interfaces

Connection Port	USB 3.0 (micro B), external power supply terminal, cable switch terminal, X-sync socket, HDMI output terminal (type D), stereo microphone input terminal, headphone terminal
USB Connection	MSC/PTP

Dimensions and Weight

Dimensions	Approx. 131.5 mm (W) × 102.5 mm (H) × 77.5 mm (D) (excluding protrusions)
Weight	Approx. 785 g (Including the dedicated battery and an SD Memory Card), Approx. 700 g (body only)

Included Accessories

Package Contents	Strap O-ST132, ME Viewfinder Cap, Rechargeable Lithium-ion Battery D-LI90, Battery Charger D-BC90, AC plug cord, Software (CD-ROM) S-SW160 <Mounted to the camera> Eyecup F _s , Hot shoe cover F _k , Sync socket 2P cap, Body mount cover, Battery grip terminal cover
Software	Digital Camera Utility 5

Optional Accessories

Flucard	FLUCARD FOR PENTAX 16GB O-FC1: Remote capture, image browsing
---------	---

Approximate Image Storage Capacity and Playback Time

(When using the fully charged battery)

Battery	Temperature	Normal Shooting	Playback Time
D-LI90	23°C	720	370 minutes

- The image storage capacity (normal recording) is based on measuring conditions in accordance with CIPA standards, while other data is based on our measuring conditions. Some deviation from the above figures may occur in actual use depending on the selected capture mode and shooting conditions.

Approximate Image Storage Capacity by Size

(When using an 8 GB memory card)

Recorded Pixels	JPEG Quality			RAW
	★★★	★★	★	
L 24M	446	1010	1980	151
M 14M	755	1693	3274	–
S 6M	1670	3665	6822	–
XS 2M	4093	8469	14448	–

- The number of storable images may vary depending on the subject, shooting conditions, selected capture mode and memory card, etc.

List of World Time Cities

The following cities can be set as Hometown and Destination.

Region	City
North America	Honolulu, Anchorage, Vancouver, San Francisco, Los Angeles, Calgary, Denver, Chicago, Miami, Toronto, New York, Halifax
Central and South America	Mexico City, Lima, Santiago, Caracas, Buenos Aires, Sao Paulo, Rio de Janeiro
Europe	Lisbon, Madrid, London, Paris, Amsterdam, Milan, Rome, Copenhagen, Berlin, Prague, Stockholm, Budapest, Warsaw, Athens, Helsinki, Moscow
Africa/ West Asia	Dakar, Algiers, Johannesburg, Istanbul, Cairo, Jerusalem, Nairobi, Jeddah, Tehran, Dubai, Karachi, Kabul, Male, Delhi, Colombo, Kathmandu, Dacca
East Asia	Yangon, Bangkok, Kuala Lumpur, Vientiane, Singapore, Phnom Penh, Ho chi Minh, Jakarta, Hong Kong, Beijing, Shanghai, Manila, Taipei, Seoul, Tokyo, Guam
Oceania	Perth, Adelaide, Sydney, Noumea, Wellington, Auckland, Pago Pago

Operating Environment for USB Connection and Provided Software

With the provided software “Digital Camera Utility 5”, you can develop RAW files, make color adjustments, or check shooting information on a computer. Install the software from the provided CD-ROM (S-SW160).

We recommend the following system requirements to connect the camera to a computer and to use the software.

Windows

OS	Windows 8.1 (32-bit, 64-bit), Windows 8 (32-bit, 64-bit), Windows 7 (32-bit, 64-bit), or Windows Vista (32-bit, 64-bit)
CPU	Intel Core 2 Duo or higher
RAM	2 GB or more
HDD	For installing and starting up the program: Approx. 100 MB or more of available space For saving image files: Approx. 10 MB/file (JPEG), Approx. 30 MB/file (RAW)
Monitor	1280×1024 dots, 24-bit full color or higher

Macintosh

OS	OS X 10.10, 10.9, 10.8, or 10.7
CPU	Intel Core 2 Duo or higher
RAM	2 GB or more
HDD	For installing and starting up the program: Approx. 100 MB or more of available space For saving image files: Approx. 10 MB/file (JPEG), Approx. 30 MB/file (RAW)
Monitor	1280×1024 dots, 24-bit full color or higher

Memo

- QuickTime is required to play back movies transferred to a computer with an OS other than Windows 8 and Windows 8.1. (A computer with Windows 8 or Windows 8.1 can play back movies with a pre-installed player software.) You can download it from the following site:
<http://www.apple.com/quicktime/download/>

Symbols

menu.....	20
menu.....	23
menu.....	24
menu.....	25
C menu.....	27
mode.....	42
mode.....	35

Numerics

1× image display.....	38
1st Frame Action in AF.C.....	47

A

AA Filter Simulator.....	62
AC adapter.....	32
Action in AF.C Continuous.....	47
AE Metering.....	44
AE-L with AF Locked.....	27
AF area.....	48
AF Assist Light.....	7, 46
AF Button.....	80
AF coupler.....	7
AF Fine Adjustment.....	49
AF frame.....	36, 37
AF Mode.....	46, 48
AF point.....	47
AF with Remote Control.....	52

AFA	46
AFC	46
AFS	46
AF.S Setting.....	47
Anti-aliasing filter.....	62

Aperture Priority Automatic Exposure.....	40
Aperture value.....	40
Aspect Ratio.....	73, 77
ASTROTRACER.....	66
Auto (AF point).....	47
Auto EV Compensation.....	27
Auto Flash Discharge.....	45
Auto Image Rotation.....	70
AUTO ISO Parameters.....	43
Auto mode (AF Mode).....	46
Auto Power Off.....	33
Auto Resize.....	87
Auto Screen Rotation.....	13
Autofocus.....	46
AV device.....	70
Av mode.....	40
AWB in Tungsten Light.....	56

B

B mode.....	40
Base Parameter Adj (Digital Filter).....	74
Battery.....	30
Battery grip contacts.....	7
Bleach Bypass (Custom Image).....	58
Bold Monochrome (Digital Filter).....	59, 74
Bracketing.....	52
Bracketing Order.....	53
Bright (Custom Image).....	58
Brightness adjustment.....	60
Brightness histogram.....	16
Bulb (B) Mode Options.....	27
Bulb Exposure.....	40

Button.....	8
Button Customization.....	79

C

Cable switch terminal.....	7
Calendar Filmstrip Display.....	69
Calibration.....	64
Capture mode.....	40
Capture mode selector switch.....	35
Card access lamp.....	7
Catch-in Focus.....	28
Center-weighted metering.....	44
Changing the image size.....	72
Charging the battery.....	30
Charging time.....	31
City names.....	33, 100
Cleaning.....	93
Color Fringe Correction... ..	77
Color Moiré Correction... ..	73
Color Space.....	28, 85
Color Temperature.....	57
Color Temperature Steps.....	56
Composition Adjust.....	62
Computer.....	71
Continuous mode (AF Mode).....	46
Continuous playback.....	69
Continuous Shooting.....	51
Contrast.....	58
Contrast AF.....	48
Contrast detection AF.....	46
Control panel.....	12, 18

Copyright Holder.....	86
Copyright Information.....	86
Correcting images.....	60
Create New Folder.....	85
Cropping.....	73
Cross Processing (Custom Image).....	58
CTE	56
Custom Image.....	58
Custom Setting menus.....	27
Customization.....	79

D

Date Adjustment.....	34
Date Format.....	34
DC input terminal.....	32
Delete.....	38
Delete All Images.....	24
Deleting selected images.....	68
Destination.....	82
Detailed Information Display.....	15
Developing RAW images.....	77
Dial.....	8
Dial indicator.....	36
Diffraction Correction.....	61
Digital Camera Utility 5.....	101
Digital Filter.....	59, 74
Digital Preview.....	49
Dioptr adjustment dial... ..	17
Direct keys.....	18
Display Color.....	12
Distortion Correction.....	61
DNG.....	39

D-Range Settings	60	Flash Mode.....	45	I	Lens focal length	91
Drive Mode	50	Flash On.....	45	Image Capture	Lens information	
DST (daylight saving		Flash X-sync Speed	40	Settings	contacts	7
time)	34, 82	Flack Reduction.....	26	Image Copy.....	7, 29	
Dust Alert.....	93	Flucard	32, 86	Image finishing tone	29	
Dust Removal.....	93	Focus indicator.....	36	Image plane indicator	90	
Dynamic range	60	Focus Method.....	46	Image storage	Lever.....	8
E		Focus mode switch....	36, 46	capacity.....	Link AE and AF Point	27
E-dial	79	Focus Peaking.....	48	Index.....	Live View	11, 21, 37
Editing images.....	72	Folder display	69	Initial settings.....		
Electronic Compass	13	Folder Name.....	84	Initializing a memory		
Electronic Level.....	13, 17	Format	35	card		
Error messages	94	Four-way controller.....	9, 18	Input Focal Length.....		
EV Compensation	41	Framerate.....	39	Instant Review		
EV Steps	41	G		Interval Composite		
Exif data	86	GPS.....	63	Interval Movie Record		
Expanded Area AF		GPS Indicator Lamp ...	7, 64	Interval Shooting		
(AF point).....	47	GPS Logging.....	65	Invert Color		
Exposure Bracketing	52	GPS Time Sync.....	63	(Digital Filter).....		
Exposure modes	40, 82	Green mode	35	ISO AUTO Setting.....		
Exposure Setting		Grid Display.....	21	ISO sensitivity.....		
(movie).....	42	Guide Display	25, 36	J		
External flash.....	91	H		JPEG		
Extract Color		HDMI Out	71	K		
(Digital Filter).....	59, 74	HDR Capture.....	60	Kelvin.....		
Eye-Fi card	32, 86	Headphones	42	L		
Eye-Fi Image Transfer.....	87	High Contrast		Landscape (Custom		
F		(Digital Filter).....	59, 74	Image).....		
Face Detection		High-ISO NR	44	Language setting		
(Contrast AF)	48	Highlight Alert	21, 24	Language/言語		
File Format	39	Highlight Correction	60	Lat-Chromatic-Ab Adj		
File Name	85	Histogram Display	16, 21	LCD Display		
File No.	86	Hold AF Status	47	LCD Display Settings		
Filter	59, 74	Hometown	33, 82	LCD panel		
Firmware	26	Horizon Correction	21	LCD Panel		
Firmware Info/Options.....	26	Hot shoe	7, 45	Illumination.....		
Fish-eye (Digital Filter)	74			Lens.....		
Flash.....	45, 91			Lens Correction		
Flash compensation	45					

MSC	93	Processing images	72	Save Cross Processing	59	Single mode (AF Mode)	46
Multi-exposure	53	Program Automatic Exposure	40	Save Menu Location	19	Sketch (Digital Filter)	74
Multi-image display	68	Program Line	41	Save RAW Data	36, 38	Slideshow	69
Multiple AF Points (Contrast AF)	48	Protect	83	Save Rotation Info	70	Slim (Digital Filter)	74
Multi-segment metering	44	Protect All Images	83	SD Memory Card	32	Slow Shutter Speed NR	41
Muted (Custom Image)	58	Provided software	101	Select (AF point)	47	Slow-speed Sync	45
N		PTP	93	Select (Contrast AF)	48	Soft (Digital Filter)	74
Natural (Custom Image)	58	Q		Select Battery	31	Sound	42
Noise Reduction	41, 44	Quality	39	Self-timer lamp	7	Sound Effects	25
O		Quick Zoom	38	Self-timer shooting	51	Speaker	7
One Push File Format	80	QuickTime	101	Sensitivity	43	Specifications	96
One-Push Bracketing	53	R		Sensitivity Priority Automatic Exposure	40	Spot (AF point)	47
Operating environment	101	Radiant (Custom Image)	58	Sensitivity Steps	43	Spot (Contrast AF)	48
Optical Preview	49	RAW	39	Sensor Cleaning	94	Spot metering	44
P		RAW Development	77	Sequential Numbering	86	Standby mode	10
P mode	40	RAW/Fx Button	80	Set-up menus	25	Starburst (Digital Filter)	74
Pastel (Digital Filter)	74	Rec. Mode menus	20	Shading (Digital Filter)	59, 74	Status Screen	10
PEF	39	Recordable time	42	Shadow Correction	60	Strap	29
Peripheral Illumin. Corr.	61	Recorded Pixels	39	Shake Reduction	21	Superimpose AF Area	17
Photographer	86	Recording Sound Level	23, 42	Sharpness	58	Sv mode	40
Pixel Mapping	93	Red-eye Reduction	45	Shooting	35	Switch	8
Pixel Shift Resolution	61	Remote control receiver	7	Shooting celestial bodies	66	T	
Playback Info Display selection screen	14	Remote Control shooting	52	Shooting Info Display	13	TAv mode	40
Playback menu	24	Reset	26, 28	Shooting with flash	45	Text input	81
Playback mode	38	Resize	73	Shooting with viewfinder	35	Text Size	34
Playback mode palette	67	Retractable lens	37	Shutter & Aperture Priority Automatic Exposure	40	Thumbnail display	38, 68
Portrait (Custom Image) ..	58	Retro (Digital Filter) ..	59, 74	Shutter Priority Automatic Exposure	40	Time Setting	82
Posterization (Digital Filter)	74	Reversal Film (Custom Image)	58	Shutter speed	40	Tone Expansion (Digital Filter)	74
Power	33	RGB histogram	16	Single Frame Shooting	50	Toy Camera (Digital Filter)	59, 74
Preview	49	Rotating images	70	Single image autofocus	46	Tracking (Contrast AF)	48
Preview Dial	49	Rotation Direction	79	display	14, 38	Tripod socket	7
		S				TTL phase-matching	
		Save as Manual WB	57			autofocus	46
						Tv mode	40

U

Unicolor Bold (Digital Filter).....	59, 74
Updating firmware	26
USB Connection.....	72, 101
USB terminal	71
USER mode	81
User registration	6
Using aperture ring.....	90

V

Vertical position	13
Vibrant (Custom Image)	58
Viewfinder.....	16
Volume label.....	35

W

WARRANTY POLICY.....	110
Water Color (Digital Filter).....	74
WB Adjustable Range	56
WB When Using Flash	56
White Balance	56
Wi-Fi transmission	86
Windows	101
Wireless LAN.....	86
Wireless Memory Card	86
World Time	82

X

X mode	40
X-sync socket	92

Z

Zone Select (AF point)	47
Zoom Review	36, 37, 38

For Using Your Camera Safely

We have paid close attention to the safety of this camera. When using this camera, we request your special attention regarding items marked with the following symbols.



Warning

This symbol indicates that ignoring this item could cause serious personal injuries.



Caution

This symbol indicates that ignoring this item could cause minor or medium personal injuries, or loss of property.

About the Camera



Warning

- Do not disassemble or modify the camera. High voltage areas are present inside the camera, with the risk of electric shock.
- If the camera interior is exposed due to dropping or otherwise damaging the camera, never touch the exposed portion. There is a risk of electric shock.
- Do not aim the camera at the sun or other strong light sources when taking pictures or leave the camera sitting in direct sunlight with a lens cap off. Doing so may cause the camera to malfunction or cause a fire.
- Do not look at the sun or other strong light sources through a lens. Doing so may lead to a loss of eyesight or cause vision to be impaired.
- If any irregularities occur during use, such as smoke or a strange odor, stop use immediately, remove the battery or the AC adapter, and contact your nearest service center. Continued use can cause a fire or electric shock.



Caution

- Do not place your finger over the flash when discharging the flash. You may burn yourself.
- Do not cover the flash with clothing when discharging the flash. Discoloration may occur.
- Some portions of the camera heat up during use. There is a risk of low temperature burns when holding such portions for long periods.
- Should the monitor be damaged, be careful of glass fragments. Also, be careful not to allow the liquid crystal to get on your skin or in your eyes or mouth.
- Depending on your individual factors or physical condition, the use of the camera may cause itching, rashes or blisters. In case of any abnormality, stop using the camera and get medical attention immediately.

About the Battery Charger and AC Adapter



Warning

- Always use the battery charger and AC adapter exclusively developed for this camera, with the specified power and voltage. Using a battery charger or AC adapter not exclusive to this camera, or using the exclusive battery charger or AC adapter with an unspecified power or voltage can cause a fire, electric shock, or camera breakdown. The specified voltage is 100 - 240V AC.
- Do not disassemble or modify the product. This can cause a fire or electric shock.
- If the generation of smoke or strange odor from the product or other abnormality occurs, immediately discontinue using and consult your nearest service center. Continued use can cause a fire or electric shock.
- If water should happen to get inside the product, consult your nearest service center. Continued use can cause a fire or electric shock.
- If you see a lightning flash or hear thunder during use of the battery charger or AC adapter, unplug the power plug and discontinue using. Continued use can cause damage to the product, fire or electric shock.
- Wipe off the power plug if it should become covered with dust. Accumulated dust may cause a fire.
- To reduce the risk of hazards, use only CSA/UL certified power supply cord set, cord is Type SPT-2 or heavier, minimum NO.18 AWG copper, one end with a molded-on male attachment plug cap (with a specified NEMA configuration), and the other is provided with a molded-on female connector body (with a specified IEC nonindustrial type configuration) or the equivalent.



Caution

- Do not place or drop heavy objects on or forcefully bend the AC plug cord. Doing so may damage the cord. Should the AC plug cord be damaged, consult your nearest service center.
- Do not touch or short-circuit the terminal area of the AC plug cord while the cord is plugged in.
- Do not handle the power plug with wet hands. This can cause an electric shock.
- Do not drop the product, or subject it to violent impact. This can cause the product to breakdown.
- Do not use the battery charger D-BC90 to charge batteries other than the rechargeable lithium-ion battery D-LI90. Attempting to charge other types of batteries may cause an explosion or heating, or may damage the battery charger.

About the Rechargeable Lithium-ion Battery

Warning

- If any leakage from the battery should come in contact with your eyes, do not rub them. Flush your eyes with clean water and get medical attention immediately.

Caution

- Only use the specified battery with this camera. Use of other batteries may cause an explosion or fire.
- Do not disassemble the battery. Disassembling the battery may cause an explosion or leakage.
- Remove the battery from the camera immediately if it becomes hot or begins to smoke. Be careful not to burn yourself during removal.
- Keep wires, hairpins, and other metal objects away from the + and - contacts of the battery.
- Do not short the battery or dispose of the battery in fire. This can cause an explosion or fire.
- If any leakage from the battery should come in contact with skin or clothing, it may cause irritation to the skin. Wash the affected areas thoroughly with water.
- Precautions for D-L190 Battery Usage:
 - USE SPECIFIED CHARGER ONLY. RISK OF FIRE AND BURNS.
 - DO NOT INCINERATE.
 - DO NOT DISASSEMBLE.
 - DO NOT SHORT CIRCUIT.
 - DO NOT EXPOSE TO HIGH TEMP. (140°F / 60°C)
 - SEE MANUAL.

Keep the Camera and its Accessories out of the Reach of Small Children

Warning

- Do not place the camera and its accessories within the reach of small children.
 1. If the product falls or is operated accidentally, it may cause serious personal injuries.
 2. Wrapping the strap around a neck may cause suffocation.
 3. To avoid the risk of a small accessory such as the battery or memory cards from being swallowed by mistake, keep them out of the reach of small children. Seek medical attention immediately if an accessory is accidentally swallowed.

Care to be Taken During Handling

Before Using Your Camera

- When the camera has not been used for a long time, confirm that it is still working properly, particularly prior to taking important pictures (such as at a wedding or when traveling). Contents of the recording cannot be guaranteed if recording, playback or transferring your data to a computer, etc. is not possible due to a malfunction of your camera or recording media (memory cards), etc.

About the Battery and Charger

- To keep the battery in optimum condition, avoid storing it in a fully charged state or in high temperatures.
- If the battery is left inserted and the camera is not used for a long time, the battery will over-discharge and shorten the battery's life.
- Charging the battery a day before use or on the day of use is recommended.
- The AC plug cord provided with this camera is developed exclusively for the battery charger D-BC90. Do not use it with other devices.

Precautions on Carrying and Using Your Camera

- Do not subject the camera to high temperatures or high humidity. Do not leave the camera in a vehicle, as the temperature can get very high.
- Do not subject the camera to strong vibrations, shocks, or pressure. Use a cushion to protect the camera from vibrations of motorcycles, automobiles, or ships.
- The temperature range for camera use is -10°C to 40°C (14°F to 104°F). The monitor may appear black at high temperatures, but will return to normal at normal temperatures.
- The monitor may respond more slowly at low temperatures. This is due to liquid crystal properties, and is not a malfunction.
- Sudden temperature changes will cause condensation on the inside and outside of the camera. Place the camera in your bag or a plastic bag, and remove it after temperatures of the camera and surroundings are equalized.
- Avoid contact with garbage, mud, sand, dust, water, toxic gases, or salt. These could cause the camera to breakdown. Wipe the camera to dry off any rain or water drops.
- Do not press on the monitor with excessive force. This could cause it to break or malfunction.
- Be careful not to overtighten the screw in the tripod socket when using a tripod.

Cleaning Your Camera

- Do not clean the camera with organic solvents such as thinner, alcohol, and benzene.
- Use a lens brush to remove dust accumulated on a lens. Never use a spray blower for cleaning as it may damage the lens.
- Please contact your nearest service center for professional cleaning of the CMOS sensor. (This will involve a fee.)
- Periodic inspections are recommended every one to two years to maintain high performance.

Storing Your Camera

- Do not store the camera with preservatives or chemicals. Storage in high temperatures and high humidity can cause mold to grow on the camera. Remove the camera from its case and store it in a dry and well-ventilated place.
- Avoid using or storing the camera where it may be exposed to static electricity or electrical interference.
- Avoid using or storing the camera in direct sunlight or in locations where it may be exposed to rapid changes in temperature or to condensation.

About SD Memory Cards

- The SD Memory Card is equipped with a write-protect switch. Setting the switch to LOCK prevents new data from being recorded on the card, the stored data from being deleted, and the card from being formatted by the camera or computer.
- The SD Memory Card may be hot when removing the card immediately after using the camera.
- Do not remove the SD Memory Card or turn off the power while the card is being accessed. This may cause the data to be lost or the card to be damaged.
- Do not bend the SD Memory Card or subject it to violent impact. Keep it away from water and store away from high temperatures.
- Do not remove the SD Memory Card while formatting. The card may be damaged and become unusable.
- Data on the SD Memory Card may be deleted in the following circumstances. We do not accept any liability for data that is deleted if
 1. the SD Memory Card is mishandled by the user.
 2. the SD Memory Card is exposed to static electricity or electrical interference.
 3. the SD Memory Card has not been used for a long time.

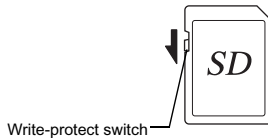

4. the SD Memory Card or the battery is removed while the card is being accessed.
- If the SD Memory Card is not used for a long time, the data on the card may become unreadable. Be sure to regularly make a backup of important data on a computer.
 - Format new SD Memory Cards. Also format SD Memory Cards previously used with other cameras.
 - Please note that deleting data stored on an SD Memory Card, or formatting an SD Memory Card does not completely erase the original data. Deleted data can sometimes be recovered using commercially available software. If you are going to discard, give away or sell your SD Memory Card, you should ensure that the data on the card is completely deleted or the card itself is destroyed if it contains any personal or sensitive information.
 - The data on your SD Memory Card should be managed at your own risk.

About Eye-Fi Cards

- An SD Memory Card with a built-in wireless LAN ("Eye-Fi card") can be used with this camera.
- Use of an access point and an Internet connection are required for transferring images via wireless LAN. For details, refer to the Eye-Fi website. (<http://www.eye.fi>)
- Update your Eye-Fi card to the latest firmware before using it.
- Set [Action Mode] to [OFF], or do not use an Eye-Fi card in a location where the use of wireless LAN devices is restricted or prohibited, such as airplanes.
- An Eye-Fi card can be used only in the country in which the card was purchased. Please observe all local laws governing the Eye-Fi card usage.
- This camera features a function to enable/disable the communication function of the Eye-Fi card, however, we do not guarantee the operability of all Eye-Fi card functions.
- Refer to the Eye-Fi card manual for details on how to use the card.
- Please contact the Eye-Fi card manufacturer regarding any malfunctions or problems concerning Eye-Fi cards.

About the GPS

- Local geographic and atmospheric conditions may prevent or delay the reception of GPS data. This camera may be unable to receive GPS data indoors, underground, or near large structures, trees, or other objects that block or reflect satellite signals.
- The positions of GPS satellites are continuously changing and this may prevent or delay the reception of GPS data at certain hours of the day.
- The presence of mobile phones or other devices that transmit frequencies close to those of GPS satellites, or magnetized high-voltage lines may interfere with the reception of GPS data.

- Note that this camera may take a while to reacquire a signal if it has not been used for an extended period or has been moved a great distance from where the GPS data was last received.
- Turn off the GPS function in any place where, or on any occasion when the use of electronic device is prohibited, such as while visiting a hospital, or taking off and landing of airplane.
- In some countries or regions, using GPS or collecting positioning data may be regulated. When you travel overseas, consult the embassy or your travel agency about using a camera with a GPS function or collecting the positioning log data.
- The GPS function of this camera has been developed for personal-use digital cameras. It cannot be used for surveying or for a navigation system for airplanes, vehicles, or people, etc. We assume no responsibility nor liability for any damages resulting from the use of the function for improper purposes.

Trademarks

- Microsoft, Windows, and Windows Vista are registered trademarks of Microsoft Corporation in the United States of America and other countries.
- Macintosh, OS X, and QuickTime are trademarks of Apple Inc., registered in the U.S. and other countries.
- Intel and Intel Core are trademarks of Intel Corporation in the U.S. and/or other countries.
- SDXC Logo is a trademark of SD-3C, LLC.
- Eye-Fi, the Eye-Fi logo, and Eye-Fi *connected* are trademarks of Eye-Fi, Inc.
- Google and Google Earth are trademarks or registered trademarks of Google Inc.
- This product includes DNG technology under license by Adobe Systems Incorporated.
- The DNG logo is either a registered trademark or trademark of Adobe Systems Incorporated in the United States and/or other countries.
- HDMI, the HDMI logo and High-Definition Multimedia Interface are trademarks or registered trademarks of HDMI Licensing, LLC in the United States and/or other countries.

All other trademarks are the property of their respective owners.

- This product supports PRINT Image Matching III. PRINT Image Matching enabled digital still cameras, printers and software help photographers to produce images more faithful to their intentions. Some functions are not available on printers that are not PRINT Image Matching III compliant.
Copyright 2001 Seiko Epson Corporation. All Rights Reserved. PRINT Image Matching is a trademark of Seiko Epson Corporation. The PRINT Image Matching logo is a trademark of Seiko Epson Corporation.



AVC Patent Portfolio License

This product is licensed under the AVC Patent Portfolio License for the personal use of a consumer or other uses in which it does not receive remuneration to (i) encode video in compliance with the AVC standard ("AVC video") and/or (ii) decode AVC video that was encoded by a consumer engaged in a personal activity and/or was obtained from a video provider licensed to provide AVC video. No license is granted or shall be implied for any other use.

Additional information may be obtained from MPEG LA, L.L.C.
See <http://www.mpegla.com>.

Announcement on the Use of BSD-Licensed Software

This product includes software licensed under the BSD License. BSD license is a form of license which permits the redistribution of the software provided that it is clearly stated that use is unwarranted, and a copyright notice and a list of licensing conditions are provided. The following contents are displayed based on the abovementioned licensing conditions and are not for the purpose of restricting your use of the product, etc.

Tera Term

Copyright (c) T.Teranishi.

Copyright (c) TeraTerm Project.

All rights reserved.

Redistribution and use in source and binary forms, with or without modification, are permitted provided that the following conditions are met:

1. Redistributions of source code must retain the above copyright notice, this list of conditions and the following disclaimer.
2. Redistributions in binary form must reproduce the above copyright notice, this list of conditions and the following disclaimer in the documentation and/or other materials provided with the distribution.
3. The name of the author may not be used to endorse or promote products derived from this software without specific prior written permission.

THIS SOFTWARE IS PROVIDED BY THE AUTHOR "AS IS" AND ANY EXPRESS OR IMPLIED WARRANTIES, INCLUDING, BUT NOT LIMITED TO, THE IMPLIED WARRANTIES OF MERCHANTABILITY AND FITNESS FOR A PARTICULAR PURPOSE ARE DISCLAIMED. IN NO EVENT SHALL THE AUTHOR BE LIABLE FOR ANY DIRECT, INDIRECT, INCIDENTAL, SPECIAL, EXEMPLARY, OR CONSEQUENTIAL DAMAGES (INCLUDING, BUT NOT LIMITED TO, PROCUREMENT OF SUBSTITUTE GOODS OR SERVICES; LOSS OF USE, DATA, OR PROFITS; OR BUSINESS INTERRUPTION) HOWEVER CAUSED AND ON ANY THEORY OF LIABILITY, WHETHER IN CONTRACT, STRICT LIABILITY, OR TORT (INCLUDING NEGLIGENCE OR OTHERWISE) ARISING IN ANY WAY OUT OF THE USE OF THIS SOFTWARE, EVEN IF ADVISED OF THE POSSIBILITY OF SUCH DAMAGE.

WARRANTY POLICY

All our cameras purchased through authorized bona fide photographic distribution channels are guaranteed against defects of material or workmanship for a period of twelve months from the date of your purchase. Service will be rendered, and defective parts will be replaced without cost to you within that period, provided the camera does not show evidence of impact, sand or liquid damage, mishandling, tampering, battery or chemical corrosion, operation contrary to operating instructions, or modification by an unauthorized repair shop. The manufacturer or its authorized representatives shall not be liable for any repair or alterations except those made with its written consent and shall not be liable for damages from delay or loss of use or from other indirect or consequential damages of any kind, whether caused by defective material or workmanship or otherwise; and it is expressly agreed that the liability of the manufacturer or its representatives under all guarantees or warranties, whether expressed or implied, is strictly limited to the replacement of parts as hereinbefore provided. No refunds will be made on repairs by non-authorized service facilities.

Procedure During 12-month Warranty Period

Any camera which proves defective during the 12-month warranty period should be returned to the dealer from whom you purchased the camera or to the manufacturer. If there are no representatives of the manufacturer in your country, send the camera to the manufacturer, with postage prepaid. In this case, it will take a considerable length of time before the camera can be returned to you owing to the complicated customs procedures required. If the camera is covered by warranty, repairs will be made and parts replaced free of charge, and the camera will be returned to you upon completion of servicing. If the camera is not covered by warranty, regular charges of the manufacturer or of its representatives will apply. Shipping charges are to be borne by the owner. If your camera was purchased outside of the country where you wish to have it serviced during the warranty period, regular handling and

servicing fees may be charged by the manufacturer's representatives in that country. Notwithstanding this, your camera returned to the manufacturer will be serviced free of charge according to this procedure and warranty policy. In any case, however, shipping charges and customs clearance fees to be borne by the sender. To prove the date of your purchase when required, please keep the receipt or bills covering the purchase of your camera for at least a year. Before sending your camera for servicing, please make sure that you are sending it to the manufacturer's authorized representatives or their approved repair shops, unless you are sending it directly to the manufacturer. Always obtain a quotation for the service charge, and only after you accept the quoted service charge, instruct the service station to proceed with the servicing.

- **This warranty policy does not affect the customer's statutory rights.**
- **The local warranty policies available from our distributors in some countries can supersede this warranty policy. Therefore, we recommend that you review the warranty card supplied with your product at the time of purchase, or contact our distributor in your country for more information and to receive a copy of the warranty policy.**

For customers in USA

STATEMENT OF FCC COMPLIANCE

This device complies with Part 15 of the FCC Rules. Operation is subject to the following two conditions:

(1) This device may not cause harmful interference, and (2) this device must accept any interference received, including interference that may cause undesired operation. Changes or modifications not approved by the party responsible for compliance could void the user's authority to operate the equipment.

This equipment has been tested and found to comply with the limits for a Class B digital device, pursuant to part 15 of the FCC Rules.

These limits are designed to provide reasonable protection against harmful interference in a residential installation.

This equipment generates, uses and can radiate radio frequency energy and, if not installed and used in accordance with the instructions, may cause harmful interference to radio communications. However, there is no guarantee that interference will not occur in a particular installation.

If this equipment does cause harmful interference to radio or television reception, which can be determined by turning the equipment off and on, the user is encouraged to try to correct the interference by one or more of the following measures:

- Reorient or relocate the receiving antenna.
- Increase the separation between the equipment and receiver.
- Connect the equipment into an outlet on a circuit different from that to which the receiver is connected.

* Consult the dealer or an experienced radio/TV technician for help.

FOR CALIFORNIA, U.S.A. ONLY

Perchlorate Material-special handling may apply.
The lithium battery used in this camera contains perchlorate material, which may require special handling.
See www.dtsc.ca.gov/hazardouswaste/perchlorate

For customers in Canada

This Class B digital apparatus complies with Canadian ICES-003.

Pour les utilisateurs au Canada

Cet appareil numérique de la classe B est conforme à la norme NMB-003 du Canada.

Declaration of Conformity According to 47CFR, Parts 2 and 15 for Class B Personal Computers and Peripherals

We: RICOH IMAGING AMERICAS CORPORATION

Located at: 633 17th Street, Suite 2600
Denver, Colorado 80202 U.S.A.
Phone: 800-877-0155
FAX: 303-790-1131

Declare under sole responsibility that the product identified herein complies with 47CFR Parts 2 and 15 of the FCC rules as a Class B digital device. Each product marketed is identical to the representative unit tested and found to be compliant with the standards. Records maintained continue to reflect the equipment being produced can be expected to be within the variation accepted, due to quantity production and testing on the statistical basis as required by 47CFR §2.909.

Operation is subject to the following two conditions:

(1) This device may not cause harmful interference, and (2) This device must accept any interference received, including interference that may cause undesired operation. The above named party is responsible for ensuring that the equipment complies with the standards of 47CFR §15.101 to §15.109.

Product Name: SLR Digital Camera

Model Number: PENTAX K-3 II

Contact person: Customer Service Manager

Date and Place: April, 2015, Colorado

Information for Users on Collection and Disposal of Old Equipment and Used Batteries



1. In the European Union

These symbols on the products, packaging and/ or accompanying documents mean that used electrical and electronic equipment and batteries should not be mixed with general household waste.

Used electrical/electronic equipment and batteries must be treated separately and in accordance with legislation that requires proper treatment, recovery and recycling of these products.



By disposing of these products correctly you will help ensure that the waste undergoes the necessary treatment, recovery and recycling and thus prevent potential negative effects on the environment and human health which could otherwise arise due to inappropriate waste handling.

If a chemical symbol is added beneath the symbol shown above, in accordance with the Battery Directive, this indicates that a heavy metal (Hg = Mercury, Cd = Cadmium, Pb = Lead) is present in the battery at a concentration above an applicable threshold specified in the Battery Directive.

For more information about collection and recycling of used products, please contact your local authorities, your waste disposal service or the point of sale where you purchased the products.

2. In other countries outside the EU

These symbols are only valid in the European Union. If you wish to discard used products, please contact your local authorities or dealer and ask for the correct method of disposal.

For Switzerland: Used electrical/electronic equipment can be returned free of charge to the dealer, even when you don't purchase a new product. Further collection facilities are listed on the home page of www.swico.ch or www.sens.ch.



The CE Mark is a Directive conformity mark of the European Union.

RICOH IMAGING COMPANY, LTD.

2-35-7, Maeno-cho, Itabashi-ku, Tokyo 174-8639, JAPAN
(<http://www.ricoh-imaging.co.jp>)

**RICOH IMAGING EUROPE
S.A.S.**

Parc Tertiaire SILIC 7-9, avenue Robert Schuman - B.P. 70102,
94513 Rungis Cedex, FRANCE
(<http://www.ricoh-imaging.eu>)

**RICOH IMAGING AMERICAS
CORPORATION**

633 17th Street, Suite 2600, Denver, Colorado 80202, U.S.A.
(<http://www.us.ricoh-imaging.com>)

**RICOH IMAGING CANADA
INC.**

5520 Explorer Drive Suite 300, Mississauga, Ontario, L4W 5L1, CANADA
(<http://www.ricoh-imaging.ca>)

**RICOH IMAGING CHINA CO.,
LTD.**

23D, Jun Yao International Plaza, 789 Zhaojiabang Road, Xu Hui District,
Shanghai, 200032, CHINA
(<http://www.ricoh-imaging.com.cn>)

This contact information may change without notice.
Please check the latest information on our websites.

- Specifications and external dimensions are subject to change without notice.