

# RICOH

Digital Camera

# PENTAX Q-S1

## Operating Manual

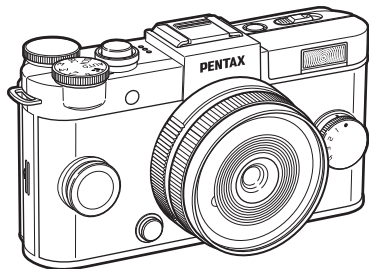

**Introduction** **1**

**Getting Started** **2**

**Shooting** **3**

**Playback** **4**

**Settings** **5**

**Appendix** **6**

To ensure the best performance from your camera, please read the Operating Manual before using the camera.

## Checking the Contents of the Package



Hot shoe cover Fk  
(Installed on camera)



Q body mount cover  
(Installed on camera)

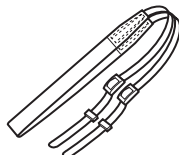

Strap  
O-ST131

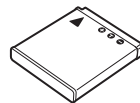

Rechargeable lithium-ion  
battery D-LI68

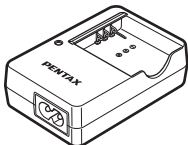

Battery charger  
D-BC68P



AC plug cord

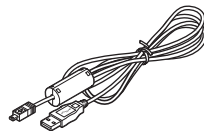

USB cable  
I-USB7

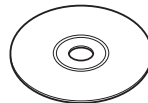

Software (CD-ROM)  
S-SW151



Start Guide

### Lenses that can be used with the PENTAX Q-S1

Lenses that can be used with the camera are Q-mount lenses. A K-mount lens can be attached to the camera with the use of the optional Adapter Q for K Mount Lens. (p.74)

**Introducing the PENTAX Q-S1**

**1**

**Getting Started**

**2**

**Taking Pictures**

**3**

**Playback Functions**

**4**

**Changing the Settings**

**5**

**Appendix**

**6**

# How to Use This Manual

## 1

### Introducing the PENTAX Q-S1 ..... p.7

Gives you an overview of the PENTAX Q-S1.  
Read this and get to know your Q-S1!

- Names and Functions of the Working Parts** ..... p.7
- How to Change Function Settings** ..... p.13
- Menu List** ..... p.15

## 2

### Getting Started ..... p.21

Explains how to get your PENTAX Q-S1 ready for shooting as well as basic operations.

- Attaching the Strap** ..... p.21
- Attaching a Lens** ..... p.21
- Using the Battery and Charger** ..... p.22
- Inserting a Memory Card** ..... p.25
- Initial Settings** ..... p.26
- Basic Shooting Operation** ..... p.28
- Reviewing Images** ..... p.29

## 3

### Taking Pictures ..... p.30

Once you've confirmed that the camera works properly, try out the camera and take lots of pictures!

- Selecting the Appropriate Capture Mode** ..... p.30
- Setting the Exposure** ..... p.35
- Using the Built-in Flash** ..... p.36
- Focusing** ..... p.37
- Setting the Drive Mode** ..... p.40
- Setting a File Format** ..... p.45
- Adjusting the Color and Brightness of Images** ..... p.45
- Controlling the Image Finishing Tone** ..... p.48

## 4

### **Playback Functions** ..... p.52

Explains various operations for playing back and editing images.

- Playback Mode Palette Items** ..... p.52
- Changing the Playback Method** ..... p.53
- Connecting the Camera to a Computer** ..... p.57
- Editing and Processing Images** ..... p.58

## 5

### **Changing the Settings** ..... p.64

Explains how to change other settings.

- Camera Settings** ..... p.64
- File Management Settings** ..... p.68

## 6

### **Appendix** ..... p.71

Provides various resources.

- Restrictions on Each Capture Mode** ..... p.71
- Functions Available with Various Lenses**  
..... p.74
- Functions when Using an External Flash**  
..... p.76
- Troubleshooting** ..... p.77
- Main Specifications** ..... p.80
- Index** ..... p.86
- For Using Your Camera Safely** ..... p.90
- Care to be Taken During Handling** ..... p.92
- WARRANTY POLICY** ..... p.95

There is a possibility that the illustrations and the display screen of the monitor in this manual are different from the actual ones.

# Contents

<b>How to Use This Manual .....</b>	<b>2</b>
-------------------------------------	----------

<b>Introducing the PENTAX Q-S1 .....</b>	<b>7</b>
--	----------

<b>Names and Functions of the Working Parts .....</b>	<b>7</b>
---	----------

Operating Controls .....	8
--------------------------	---

Monitor Display .....	9
-----------------------	---

<b>How to Change Function Settings .....</b>	<b>13</b>
--	-----------

Using the Direct Keys .....	13
-----------------------------	----

Using the Control Panel .....	13
-------------------------------	----

Using the Menus .....	14
-----------------------	----

<b>Menu List .....</b>	<b>15</b>
------------------------	-----------

Rec. Mode Menus .....	15
-----------------------	----

Movie Menu .....	17
------------------	----

Playback Menu .....	17
---------------------	----

Set-up Menus .....	18
--------------------	----

Custom Setting Menus .....	19
----------------------------	----

<b>Getting Started .....</b>	<b>21</b>
------------------------------	-----------

<b>Attaching the Strap .....</b>	<b>21</b>
----------------------------------	-----------

<b>Attaching a Lens .....</b>	<b>21</b>
-------------------------------	-----------

<b>Using the Battery and Charger .....</b>	<b>22</b>
--	-----------

Charging the Battery .....	22
----------------------------	----

Inserting/Removing the Battery .....	23
--------------------------------------	----

Using the AC Adapter .....	24
----------------------------	----

<b>Inserting a Memory Card .....</b>	<b>25</b>
--------------------------------------	-----------

<b>Initial Settings .....</b>	<b>26</b>
-------------------------------	-----------

Turning the Camera On .....	26
-----------------------------	----

Setting the Display Language .....	26
------------------------------------	----

Setting the Date and Time .....	27
---------------------------------	----

Formatting a Memory Card .....	27
--------------------------------	----

<b>Basic Shooting Operation .....</b>	<b>28</b>
---------------------------------------	-----------

<b>Reviewing Images .....</b>	<b>29</b>
-------------------------------	-----------

<b>Taking Pictures .....</b>	<b>30</b>
------------------------------	-----------

<b>Selecting the Appropriate Capture Mode .....</b>	<b>30</b>
---	-----------

Scene Modes .....	30
-------------------	----

Blur Control Mode .....	31
-------------------------	----

Exposure Modes .....	32
----------------------	----

Movie Mode .....	34
------------------	----

<b>Setting the Exposure .....</b>	<b>35</b>
-----------------------------------	-----------

Sensitivity .....	35
-------------------	----

AE Metering .....	35
-------------------	----

<b>Using the Built-in Flash .....</b>	<b>36</b>
---------------------------------------	-----------

<b>Focusing .....</b>	<b>37</b>
-----------------------	-----------

Focus Method .....	37
--------------------	----

Setting the Autofocus Method .....	38
------------------------------------	----

Adjusting the Focus Manually (Manual Focus) .....	39
---	----

<b>Setting the Drive Mode .....</b>	<b>40</b>
-------------------------------------	-----------

Continuous Shooting .....	41
---------------------------	----

Self-timer Shooting .....	41
---------------------------	----

Remote Control Shooting .....	42
-------------------------------	----

Exposure Bracketing .....	42
---------------------------	----

Multi-exposure .....	43
----------------------	----

Interval Shooting .....	43
-------------------------	----

Interval Movie Record .....	44
-----------------------------	----

<b>Setting a File Format</b> .....	<b>45</b>	<b>Changing the Settings</b> .....	<b>64</b>
Still Pictures .....	45	<b>Camera Settings</b> .....	<b>64</b>
Movies .....	45	Setting the  Functions .....	64
<b>Adjusting the Color and Brightness of Images</b> .....	<b>45</b>	Saving the Settings of a Captured Image .....	66
White Balance .....	45	Displaying the Local Date and Time of the Specified City .....	67
Adjusting Brightness .....	47	Selecting Settings to Save in the Camera .....	67
<b>Controlling the Image Finishing Tone</b> .....	<b>48</b>	<b>File Management Settings</b> .....	<b>68</b>
Custom Image .....	48	Protecting Images from Deletion (Protect) .....	68
Digital Filter .....	49	Selecting the Folder/File Number Settings .....	68
Saving Frequently Used Functions to the Quick Dial .....	50	Transferring Images via Wireless LAN .....	69
<b>Playback Functions</b> .....	<b>52</b>	<b>Appendix</b> .....	<b>71</b>
<b>Playback Mode Palette Items</b> .....	<b>52</b>	<b>Restrictions on Each Capture Mode</b> .....	<b>71</b>
<b>Changing the Playback Method</b> .....	<b>53</b>	Restrictions on the Combinations of Special Functions .....	73
Displaying Multiple Images .....	53	<b>Functions Available with Various Lenses</b> .....	<b>74</b>
Displaying Images by Folder .....	54	Using a K-Mount Lens .....	75
Displaying Images by Shooting Date .....	54	<b>Functions when Using an External Flash</b> .....	<b>76</b>
Playing Back Images Continuously (Slideshow) .....	55	<b>Troubleshooting</b> .....	<b>77</b>
Displaying Rotated Images .....	55	Error Messages .....	78
Connecting the Camera to an AV Device .....	56	<b>Main Specifications</b> .....	<b>80</b>
<b>Connecting the Camera to a Computer</b> .....	<b>57</b>	Operating Environment for USB Connection and Provided Software .....	85
<b>Editing and Processing Images</b> .....	<b>58</b>	<b>Index</b> .....	<b>86</b>
Changing the Image Size .....	58	<b>For Using Your Camera Safely</b> .....	<b>90</b>
Removing the Red-eye Effect .....	59	<b>Care to be Taken During Handling</b> .....	<b>92</b>
Processing Images with Digital Filters .....	59	<b>WARRANTY POLICY</b> .....	<b>95</b>
Creating a Composite Image (Index) .....	61		
Editing Movies .....	62		
RAW Development .....	63		

### Regarding copyrights

Images taken with this camera that are for anything other than personal enjoyment cannot be used without permission according to the rights as specified in the Copyright Act. Please take care, as there are cases where limitations are placed on taking pictures even for personal enjoyment during demonstrations, performances or of items on display. Images taken with the purpose of obtaining copyrights also cannot be used outside the scope of use of the copyright as laid out in the Copyright Act, and care should be taken here also.

### To users of this camera

- Do not use or store this camera in the vicinity of equipment that generates strong electromagnetic radiation or magnetic fields. Strong static charges or the magnetic fields produced by equipment such as radio transmitters could interfere with the monitor, damage the stored data, or affect the camera's internal circuitry and cause camera misoperation.
- The liquid crystal panel used for the monitor is manufactured using extremely high precision technology. Although the level of functioning pixels is 99.99% or better, you should be aware that 0.01% or fewer of the pixels may not illuminate or may illuminate when they should not. However, this has no effect on the recorded image.
- In this manual, the generic term "computer(s)" refers to either a Windows PC or a Macintosh.
- In this manual, the term "battery(ies)" refers to any type of batteries used for this camera and its accessories.

### Regarding User Registration

In order to better serve you, we request that you complete the user registration, which can be found on the CD-ROM supplied with the camera or on our website. Thank you for your cooperation.



# Names and Functions of the Working Parts

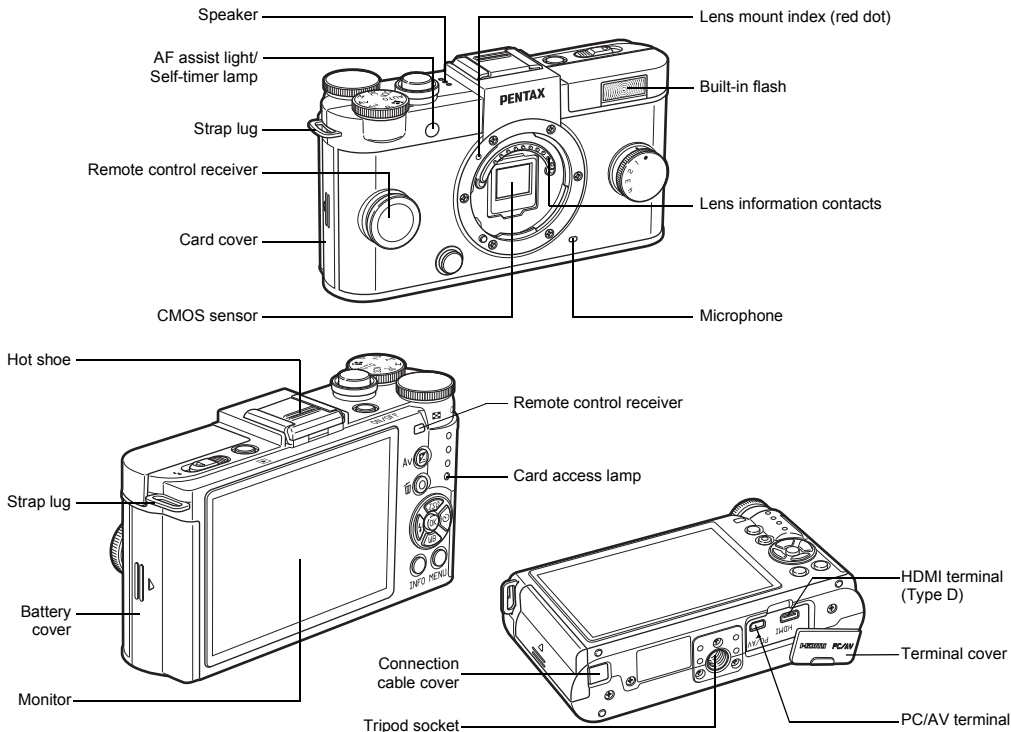

## Operating Controls

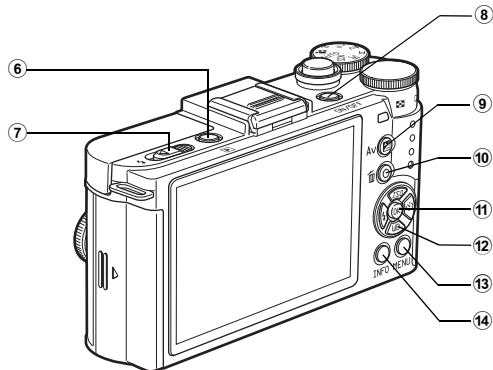
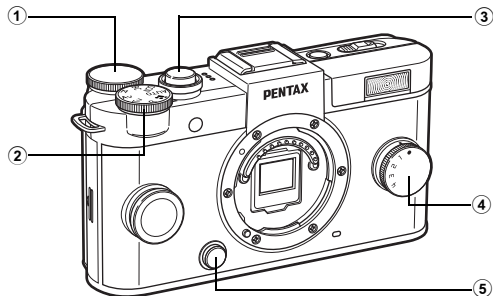

### ① E-dial (☉)

Sets the shutter speed, aperture, and exposure compensation values. (p.32)

You can change the camera settings when the control panel is displayed. (p.13)

You can change the menu tabs when a menu screen is displayed. (p.14)

In playback mode, use this to magnify an image or display multiple images at the same time. (p.53)

### ② Mode dial

Changes the capture mode. (p.28)

### ③ Shutter release button

Press to capture images. (p.28)

In playback mode, press halfway to switch to capture mode.

### ④ Quick dial

You can save your preferred shooting settings and then retrieve them easily later on. (p.50)

### ⑤ Lens unlock button

Press to detach the lens on the camera. (p.21)

### ⑥ Playback button (⏮)

Switches to playback mode. (p.29) Press the button again to switch to capture mode.

### ⑦ Flash pop-up switch

Slide to pop up the built-in flash. (p.36)

### ⑧ Power switch

Press to turn the camera on and off. (p.26)

### ⑨ EV compensation button (☉)

Press to change the exposure compensation and aperture values. (p.32)

In playback mode, the JPEG data remaining in the buffer memory is saved in RAW format. (p.29)

**10 Green/Delete button (O/📷)**

Resets the values being adjusted. Also, you can assign a function to this button. (p.64)

Press to delete images during playback. (p.29)

**11 OK button (OK)**

When the control panel or a menu is displayed, press this button to confirm the selected item.

**12 Four-way controller (▲▼◀▶)**

Displays the Sensitivity, White Balance, Flash Mode or Drive Mode setup menu. (p.13)

When the control panel or a menu is displayed, use this to move the cursor or change the item to set.

Press ▼ during playback to display the playback mode palette. (p.52)

**13 MENU button (MENU)**

Displays a menu. Press this button while the menu is displayed to return to the previous screen. (p.14)

**14 INFO button (INFO)**

Changes the style of the display on the monitor. (p.9, p.11)

**About the four-way controller**

In this manual, each button of the four-way controller is indicated as shown in the illustration on the right.

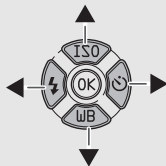
**Monitor Display****Capture Mode**

When the camera enters capture mode, the subject and the current shooting function settings are displayed on the monitor. This state is referred to as “standby mode”. Press **INFO** in standby mode to display the “control panel” and change settings. (p.13) If you press **INFO** while the control panel is displayed, you can change the type of information displayed in standby mode. (p.11)



Standby mode  
(Standard Information Display)

Control panel



Shooting Info Display  
selection screen

## Standby Mode

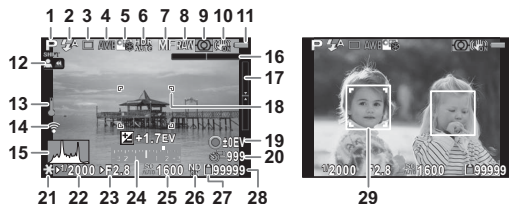

- |                              |                           |
|------------------------------|---------------------------|
| 1 Capture mode (p.30)        | 17 Electronic Level       |
| 2 Flash Mode (p.36)          | (vertical) (p.16)         |
| 3 Drive Mode (p.40)          | 18 AF frame               |
| 4 White Balance (p.45)       | 19 Reset exposure         |
| 5 Custom Image (p.48)        | compensation value        |
| 6 HDR Capture (p.47)/        | 20 Interval Shooting/     |
| Digital Filter (p.49)        | Multi-exposure (p.43)/    |
| 7 <b>MF</b> mode             | Smart Effect (p.51)       |
| 8 File Format                | 21 AE Lock                |
| 9 AE Metering (p.35)         | 22 Shutter speed          |
| 10 Shake Reduction (p.16)/   | 23 Aperture value         |
| Movie SR (p.17)              | 24 EV bar scale           |
| 11 Battery level             | 25 Sensitivity (p.35)     |
| 12 Turning the focus ring in | 26 ND Filter (p.15)       |
| <b>MF</b> mode (p.39)        | 27 Memory card            |
| 13 Temperature warning       | 28 Image storage capacity |
| 14 Eye-Fi communication      | 29 Face detection frame   |
| status                       | (when [Autofocus          |
| 15 Histogram                 | Method] is set to [Face   |
| 16 Electronic Level          | Detection]) (p.38)        |
| (horizontal) (p.16)          |                           |

## Memo

- The displayed items vary depending on the current camera setup.
- In [Live View] of the menu, you can change the style of the display in standby mode. (p.16)

## Control Panel

## mode

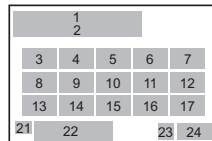

## mode

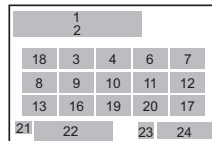
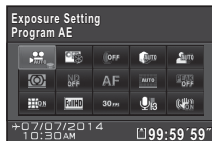

- |                         |                            |
|-------------------------|----------------------------|
| 1 Function name         | 8 AE Metering (p.35)       |
| 2 Setting               | 9 ND Filter (p.15)         |
| 3 Custom Image (p.48)/  | 10 Focus Method (p.37)     |
| <b>SCN</b> mode (p.30)  | 11 Autofocus Method (p.38) |
| 4 Digital Filter (p.49) | 12 Focus Peaking (p.39)    |
| 5 HDR Capture (p.47)    | 13 Distortion Correction   |
| 6 Highlight Correction  | (p.15)                     |
| (p.47)                  | 14 Aspect Ratio (p.45)     |
| 7 Shadow Correction     | 15 File Format (p.45)      |
| (p.47)                  |                            |

- 16 JPEG Recorded Pixels and Quality Level (p.45)/  
Movie Recorded Pixels (p.45)
- 17 Shake Reduction (p.16)/  
Movie SR (p.17)
- 18 Exposure Setting (p.34)
- 19 Framerate (p.45)
- 20 Recording Sound Level (p.17)
- 21 Destination (p.67)
- 22 Current date and time
- 23 Memory card
- 24 Number of recordable still pictures/movie recordable time

### Memo

- The items that can be selected vary depending on the current camera setup.
- If no operations are made within 1 minute while the control panel is displayed, the camera returns to standby mode.
- You can change the display color of the control panel and menus in [LCD Display] of the 1 menu. (p.18)

### Shooting Info Display

If you press while the control panel is displayed, you can select the type of information displayed in standby mode. Use to select the type and press .

<b>Standard Information Display</b>	An image and the current shooting function settings are displayed.
<b>No Information Display</b>	Only an image is displayed.
<b>Display Off</b>	Nothing is displayed on the monitor.

### Caution

- [Display Off] cannot be selected in mode.

### Playback Mode

The captured image and shooting information are displayed in single image display of the playback mode. Press to change the type of information displayed in single image display. Use to select the type and press .



<b>Standard Information Display</b>	Captured image, file format, exposure parameters, and operation guide indicators are displayed.
<b>Detailed Information Display</b>	Detailed information on how and when the image was taken is displayed. (p.12)
<b>Histogram Display</b>	Captured image and brightness histogram are displayed. (p.12) Not available during movie playback.
<b>RGB Histogram Display</b>	Captured image and RGB histogram are displayed. (p.12) Not available during movie playback.
<b>No Information Display</b>	Only the captured image is displayed.

### Memo

- The screen selected in the Playback Info Display selection screen is displayed in playback mode when the camera is turned off and on again. If [Playback Info Display] is set to [Off] in [Memory] of the 3 menu, the [Standard Information Display] always appears first when the camera is turned on. (p.67)

## Detailed Information Display

## Still pictures

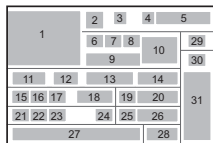

## Movies

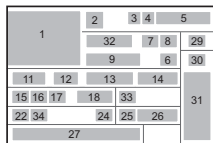

- |   |   |
|---|---|
| 1 Captured image                          | 14 EV Compensation  |
| 2 Capture mode (p.30)                     | 15 Highlight Correction (p.47)                              |
| 3 Transferred via Eye-Fi (p.69)           | 16 Shadow Correction (p.47)                                 |
| 4 Protect setting (p.68)                  | 17 Distortion Correction                                    |
| 5 Folder number-File number (p.68)        | 18 Smart Effect (p.51)                                      |
| 6 Drive Mode (p.40)                       | 19 Flash Mode (p.36)  |
| 7 AE Metering (p.35)                      | 20 Flash Exposure Compensation                              |
| 8 Shake Reduction (p.16)/ Movie SR (p.17) | 21 File Format (p.45)                                       |
| 9 Lens focal length                       | 22 JPEG Recorded Pixels (p.45)/Movie Recorded Pixels (p.45) |
| 10 Focus Method (p.37)                    | 23 JPEG Quality (p.45)                                      |
| 11 Shutter speed                          | 24 ND Filter (p.15)   |
| 12 Aperture value                         |   |
| 13 Sensitivity (p.35)                     |   |

- |  |                                |
|--|--------------------------------|
| 25 White Balance (p.45)                      | 30 Custom Image setting (p.48) |
| 26 White Balance fine-tuning                 | 31 Custom Image parameters     |
| 27 Shooting date and time                    | 32 Recording time              |
| 28 Color Space                               | 33 Sound                       |
| 29 HDR Capture (p.47)/ Digital Filter (p.49) | 34 Framerate (p.45)            |

## Histogram Display/RGB Histogram Display

Use ▲▼ to switch between the Histogram Display and RGB Histogram Display.

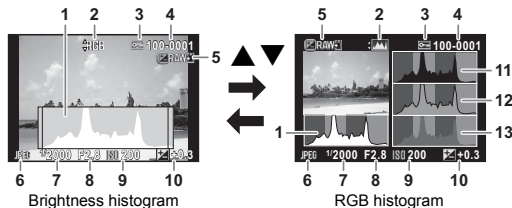

- |   |                    |
|---|--------------------|
| 1 Histogram (Brightness)                    | 7 Shutter speed    |
| 2 Switch RGB histogram/Brightness histogram | 8 Aperture value   |
| 3 Protect setting                           | 9 Sensitivity      |
| 4 Folder number-File number                 | 10 EV Compensation |
| 5 Save RAW Data                             | 11 Histogram (R)   |
| 6 File Format                               | 12 Histogram (G)   |
|   | 13 Histogram (B)   |

## How to Change Function Settings

The camera functions and their settings can be selected and changed by using the following ways.

<b>Direct keys</b>	Press ▲▼◀▶ in standby mode.
<b>Control panel</b>	Press <b>INFO</b> in standby mode. (indicated with the  icon in this manual)
<b>Menus</b>	Press <b>MENU</b> .

## Using the Direct Keys

▲	<b>Sensitivity</b>	p.35
▼	<b>White Balance</b>	p.45
◀	<b>Flash Mode</b>	p.36
▶	<b>Drive Mode</b>	p.40

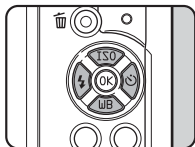

## Using the Control Panel

INFO

You can set frequently used shooting functions. Press **INFO** in standby mode.

Use ▲▼◀▶ to select an item.

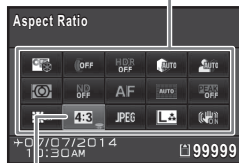

Use  to change settings.

OK

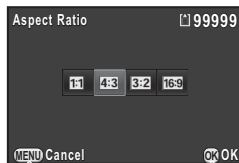

Press **MENU** to cancel setting operation.

Press **OK** to confirm the selected item and return to the control panel.

Most functions are set from the menus. Functions that can be set on the control panel can also be set from the menus.

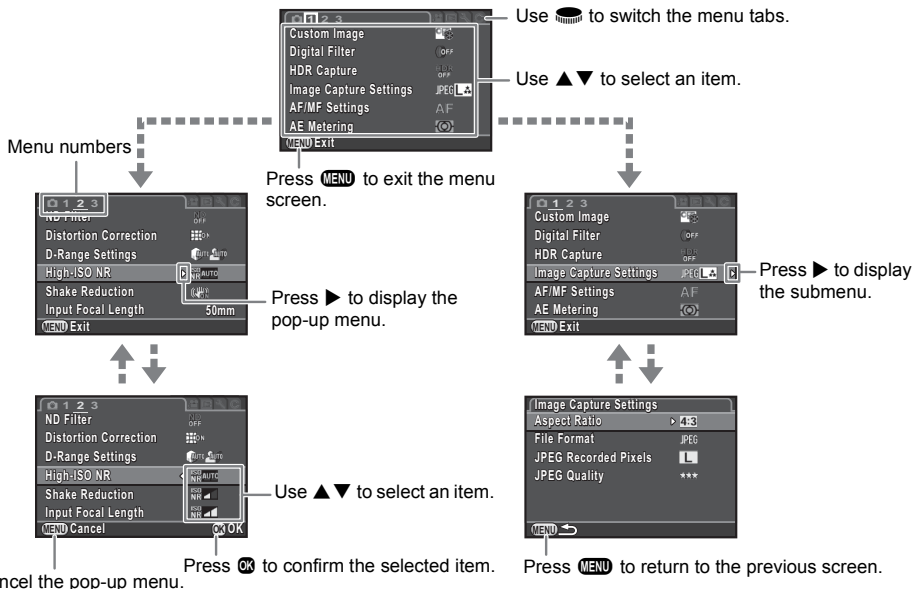







### Memo

- In capture mode, the 1 menu is always displayed first when **MENU** is pressed. To display the menu tab selected the last time first, set in [15. Save Menu Location] of the **C3** menu.
- Settings are returned to their default values with [Reset] of the 3 menu (excluding some functions).





## Rec. Mode Menus

Menu	Item	Function	Default Setting	Page	
	<b>Custom Image</b> *1	Sets the image finishing tone such as color and contrast before shooting an image.	Bright	p.48	
	<b>Digital Filter</b> *1	Applies a digital filter effect when taking pictures.	No Filter	p.49	
	<b>HDR Capture</b> *1	Enables capturing images with high dynamic range.	Off	p.47	
	<b>Image Capture Settings</b>	<b>Aspect Ratio</b> *1	Sets the horizontal and vertical ratio of images.	4:3	p.45
		<b>File Format</b> *1	Sets the file format of images.	JPEG	
		<b>JPEG Recorded Pixels</b> *1	Sets the recording size of images saved in JPEG format.	L	
		<b>JPEG Quality</b> *1	Sets the quality of images saved in JPEG format.	★★★	
	<b>AF/MF Settings</b>	<b>Focus Method</b> *1	Selects the autofocus or manual focus mode.	<b>AF</b>	p.37
		<b>Autofocus Method</b> *1	Selects the autofocus method in <b>AF</b> mode.	Multiple AF Points	p.38
		<b>AF Assist Light</b>	Sets whether to use the assist light when autofocusing in dark locations.	On	p.37
		<b>MF Autozoom</b>	Magnifies the monitor display and makes it easier to focus on the subject.	Off	p.39
		<b>Focus Peaking</b> *1	Emphasizes the outline of the subject in focus and makes it easier to check the focus.	Off	p.39
		<b>AE Metering</b> *1	Selects the part of the sensor to use for measuring brightness and determining exposure.	Multi-segment	p.35
	<b>ND Filter</b> *1	Sets whether to use the ND filter built-in to the lens.	Off	-	
	<b>Distortion Correction</b> *1	Reduces distortions occurring due to lens properties.	On	-	

Menu	Item	Function	Default Setting	Page	
	<b>D-Range Settings</b>	<b>Highlight Correction</b> *1	Expands the dynamic range and prevents bright areas from occurring.	Auto	p.47
		<b>Shadow Correction</b> *1	Expands the dynamic range and prevents dark areas from occurring.	Auto	
	<b>High-ISO NR</b>	Sets the Noise Reduction setting when shooting with a high ISO sensitivity.	Auto	p.35	
	<b>Shake Reduction</b> *1	Activates the Shake Reduction function.	On	-	
	<b>Input Focal Length</b>	Sets the focal length when using a lens for which focal length information cannot be obtained.	0.0 mm	p.75	
	<b>Live View</b>	<b>Electronic Level</b>	Displays the camera angle (horizontal and vertical) in standby mode.	On	p.10
		<b>Grid Display</b>	Displays the grid in standby mode.	Off	
		<b>Histogram Display</b>	Displays the histogram in standby mode.	Off	
		<b>Highlight Alert</b>	Bright (overexposed) areas blink red in standby mode.	Off	
	<b>Instant Review</b>	<b>Display Time</b>	Sets the Instant Review display time.	1sec.	p.28
		<b>Zoom Instant Review</b>	Sets whether to display magnified image during Instant Review.	Off	
		<b>Save RAW Data</b>	Sets whether to save the RAW image during Instant Review.	On	
		<b>Delete</b>	Sets whether to delete the displayed image during Instant Review.	On	
		<b>Histogram Display</b>	Displays the histogram during Instant Review.	Off	
	<b>Highlight Alert</b>	Bright (overexposed) areas blink red during Instant Review.	Off		
	<b>Quick Dial</b>	Assigns functions to the quick dial.	Smart Effect	p.50	
	<b>Green Button</b>	<b>Green Button</b>	Assigns a function to  .	Green Button	p.64
		<b>Action in M/TAv Mode</b>	Sets the camera action for when  is pressed in <b>M / TAv</b> mode.	P LINE	p.65
<b>E-dial in Program</b>		Sets the value to change when  is turned in <b>P</b> mode.	P SHIFT	p.65	
<b>Memory</b>		Determines which settings to save when the power is turned off.	All On except Focus Position, Digital Filter, HDR Capture	p.67	

\*1 The functions can also be set from the control panel.

## Movie Menu

Menu	Item	Function	Default Setting	Page
 1	<b>Exposure Setting</b> *1	Sets whether to adjust the shutter speed and aperture value manually.	Program AE	p.34
	<b>Digital Filter</b> *1	Applies a digital filter effect when recording a movie.	No Filter	p.49
	<b>Movie Capture Settings</b> *1	Sets the number of recorded pixels and the framerate of the movie.	 /30 fps	p.45
	<b>Movie Continuous AF</b>	Continues autofocusing even while recording a movie.	On	p.34
	<b>Recording Sound Level</b> *1	Sets the volume level for recording.	Volume level 3	-
	<b>Movie SR</b> *1	Activates the Movie Shake Reduction function.	On	-

\*1 The functions can also be set from the control panel.

## Playback Menu





Menu	Item	Function	Default Setting	Page	
 1	<b>Slideshow</b>	<b>Display Duration</b>	Sets an image display interval.	3sec.	p.55
		<b>Screen Effect</b>	Sets a transition effect when the next image is displayed.	Off	
		<b>Repeat Playback</b>	Starts the slideshow again from the beginning after the last image is displayed.	Off	
		<b>Auto Movie Playback</b>	Plays back movies during the slideshow.	On	
	<b>Quick Zoom</b>	Sets the initial magnification when magnifying images.	Off	-	
	<b>Highlight Alert</b>	Bright (overexposed) portions blink red in Standard Information Display or Histogram Display in playback mode.	Off	-	
	<b>Auto Image Rotation</b>	Rotates images which were captured with the camera held vertically or of which the rotation information has been changed.	On	p.55	
	<b>Delete All Images</b>	Deletes all saved images at once.	-	-	

## Set-up Menus

1

Introduction

Menu	Item	Function	Default Setting	Page	
1	<b>Language/言語</b>	Changes the display language.	English	p.26	
	<b>Date Adjustment</b>	Sets the date and time and the display format.	01/01/2014	p.27	
	<b>World Time</b>	Switches the displayed date and time to that of your hometown or a specified city.	Hometown	p.67	
	<b>Sound Effects</b>	Switches the operation sound on/off and changes the volume for In-focus, AE-L, Self-timer, Remote Control, One Push File Format and Shutter Sound.	Volume 3 Shutter Sound: 1 Others: On	-	
	<b>LCD Display</b>	<b>Guide Display</b>	Sets whether to display the operation guides when the capture mode is changed.	On	p.11
		<b>Display Color</b>	Sets the display color of the control panel and the menus.	1	
	<b>LCD Display Settings</b>		Adjusts the brightness and the color of the monitor.	0	-
2	<b>Flicker Reduction</b>	Cuts down on screen flicker by setting the power frequency.	50Hz	-	
	<b>Interface Options</b>	<b>Video Out</b>	Sets the output format when connecting to an AV device with a video input terminal.	-	p.56
		<b>HDMI Out</b>	Sets the output format when connecting to an AV device with an HDMI input terminal.	Auto	p.56
		<b>USB Connection</b>	Sets the USB connection mode when connecting to a computer.	MSC	p.77
	<b>Folder Name</b>		Sets the naming system for folders to store images.	Date	p.68
	<b>Create New Folder</b>		Creates a new folder on the memory card.	-	p.68
	<b>File No.</b>	<b>Sequential Numbering</b>	Sets whether to continue the sequential numbering for the file name even if a new folder is created.	On	p.69
		<b>Reset File Number</b>	Resets the file number and starts numbering from 0001 again.	-	
	<b>Eye-Fi</b>		Sets the camera action for when an Eye-Fi card is used.	Off	p.69

Menu	Item	Function	Default Setting	Page
3	<b>Power Saving</b>	Enables saving battery power by setting the monitor display to dim automatically if no operations are made within 5 seconds.	On	-
	<b>Auto Power Off</b>	Sets the time until the camera turns off automatically if no operations are made for a certain period of time.	1min.	p.26
	<b>Reset</b>	Resets the settings of the direct keys and for the items of the  menu,  menu,  menu,  menu, control panel, and playback mode palette.	-	p.14
4	<b>Pixel Mapping</b>	Maps out and corrects any defective pixels on the CMOS sensor.	-	p.78
	<b>Dust Removal</b>	Cleans the CMOS sensor by shaking it.	-	p.78
	<b>Format</b>	Formats a memory card.	-	p.27
	<b>Firmware Info/Options</b>	Displays the camera's firmware version.	-	-

## Custom Setting Menus

Menu	Item	Function	Default Setting	Page
C1	<b>1. Lens Shutter Options</b>	Sets whether to use the lens shutter and/or the electronic shutter.	Lens shutter only	p.74
	<b>2. Sensitivity Steps</b>	Sets the adjustment steps for ISO sensitivity.	1 EV Step	p.35
	<b>3. AE-L with AF Locked</b>	Sets whether to lock the exposure value when the focus is locked.	Off	-
	<b>4. Link AE and AF Point</b>	Sets whether to link the exposure and AF point in the focusing area during multi-segment metering.	Off	p.35
	<b>5. Bracketing Order</b>	Sets the order for Exposure Bracketing shooting.	0 - +	p.42
	<b>6. WB When Using Flash</b>	Sets the white balance setting when using flash.	Auto White Balance	p.46

Menu	Item	Function	Default Setting	Page
C2	<b>7. AWB in Tungsten Light</b>	Sets the tungsten light color tone when the white balance is set to <b>AWB</b> (Auto White Balance).	Subtle Correction	-
	<b>8. AF Release Options</b>	Sets the action priority for when the shutter release button is fully pressed in <b>AF</b> mode.	Focus-priority	p.38
	<b>9. AF with Remote Control</b>	Sets whether to use autofocus when shooting with a remote control unit.	Off	p.42
	<b>10. Focus Ring in AF Mode</b>	Disables the focus ring operation during <b>AF</b> mode.	Enable	p.37
	<b>11. Flash When Retracted</b>	Sets whether to discharge the built-in flash when retracted.	Discharge Flash	p.36
	<b>12. Release While Charging</b>	Sets whether to release the shutter while the built-in flash is charging.	Off	p.36
C3	<b>13. Color Space</b>	Sets the color space to use.	sRGB	-
	<b>14. Save Rotation Info</b>	Sets whether to save rotation information when shooting.	On	p.55
	<b>15. Save Menu Location</b>	Saves the last menu tab displayed on the monitor and displays it again the next time <b>MENU</b> is pressed.	Reset Menu Location	p.14
	<b>16. Auto SR Off</b>	Automatically turns off the Shake Reduction function when Self-timer or Remote Control is set.	Enable Auto SR Off	p.40
	<b>Reset Custom Functions</b>	Resets all the settings in the <b>C</b> 1-3 menus to the defaults.	-	-

## Attaching the Strap

- 1 Pass the end of the strap through the strap lug and secure it on the inside of the clasp.

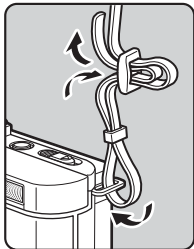

- 2 Attach the other end in the same manner.

## Attaching a Lens

- 1 Make sure that the camera is turned off.
- 2 Remove the body mount cover (1) and lens mount cover (2).

After removing the cover, be sure to put the lens down with the lens mount side facing upward.

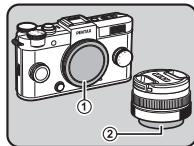

- 3 Align the lens mount index (red dots: 3) on the camera and the lens, and secure by turning the lens clockwise until it clicks.

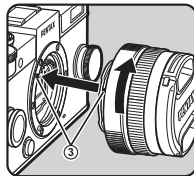

### To remove the lens

Attach the lens cap, and then turn the lens counterclockwise while holding down the lens unlock button (4).

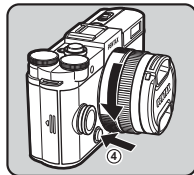

### ● Memo

- Refer to "Functions Available with Various Lenses" (p.74) for details on the functions of each lens.

**⚠ Caution**

- If the lens is removed while the power is on, the shutter release button is locked. Do not attach or remove the lens while the power is on.
- When attaching or removing the lens, choose an environment that is relatively free of dirt and dust.
- Keep the body mount cover attached on the camera when a lens is not attached.
- Be sure to attach the lens mount cover and lens cap to the lens after removing it from the camera.
- Do not insert your fingers inside the lens mount of the camera or touch the CMOS sensor.
- The camera body and lens mount incorporate lens information contacts. Dirt, dust, or corrosion may damage the electrical system. Please contact your nearest service center for professional cleaning.
- We assume no responsibility nor liability for accidents, damages and malfunctions resulting from the use of lenses made by other manufacturers.

**Using the Battery and Charger**

Use the battery D-LI68 and battery charger D-BC68P exclusively developed for this camera.

**Charging the Battery**

- 1 Connect the AC plug cord to the battery charger.**
- 2 Plug the AC plug cord into the power outlet.**

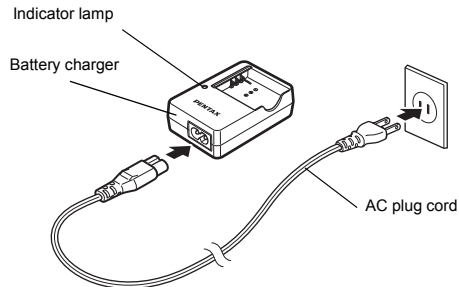

- 3 Face the ▲ mark on the battery up, and insert it into the battery charger.**

The indicator lamp is lit while charging and turns off when the battery is fully charged.

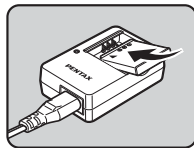



## ⚠ Caution

- Do not use the battery charger D-BC68P to charge batteries other than D-LI68. Charging other batteries may cause damage or heating.
- Replace the battery with a new one in the following cases:
  - If the indicator lamp blinks or does not light after the battery is inserted correctly
  - If the battery starts to run down more quickly even after being charged (the battery may have reached the end of its service life)

## 📄 Memo

- The maximum charging time is approximately 115 minutes (it depends on temperature and remaining battery power). Charge in a location where the temperature is between 0°C and 40°C (32°F and 104°F).

## Inserting/Removing the Battery

## ⚠ Caution

- Insert the battery correctly. If the battery is inserted incorrectly, it may not be removed.
- Wipe the electrodes of the battery with a soft dry cloth before inserting.
- Do not open the battery cover or remove the battery while the power is on.
- Be careful as the camera or battery may become hot after the camera has been used continuously for a long period of time.
- Remove the battery when you will not use the camera for a long time. The battery may leak and damage the camera if left installed during prolonged periods of non-use. If the removed battery will not be used for six months or longer, charge the battery for about 30 minutes before storing it. Be sure to recharge the battery every six to twelve months.
- Store the battery in a location where the temperature will remain at or below room temperature. Avoid locations with high temperatures.

- The date and time may be reset if you leave the battery out of the camera for long periods of time. If this happens, set the current date and time again.

## 1 Slide the battery cover in the direction of ①.

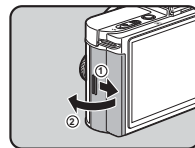

## 2 Insert the battery until it locks into place with the ▲ mark facing toward the lens. To remove the battery, push the battery lock lever in the direction of ③.

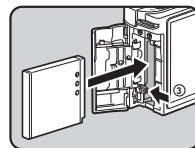

## 3 Close the battery cover, and slide it in the direction of ⑤.

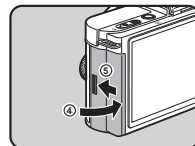

## 📄 Memo

- The battery level may not be displayed properly if the camera is used at low temperatures or when performing continuous shooting for a long time.
- Battery performance temporarily decreases as the temperature decreases. When using the camera in cold climates, have extra batteries at hand and keep them warm in your pocket. Battery performance will return to normal at room temperature.

- Have extra batteries ready when traveling overseas, or taking a lot of pictures.

## Using the AC Adapter

We recommend the use of the AC adapter kit K-AC115 (optional) when using the monitor for a long time or when connecting the camera to a computer or AV device.

- 1 Make sure that the camera is turned off, and open the battery cover.**

Remove the battery if it is inserted in the camera.

- 2 Pull down the connection cable cover (1) on the bottom side of the battery chamber, and insert the DC coupler into the battery chamber.**

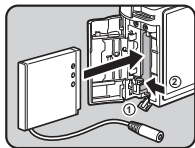

To remove the DC coupler, push the battery lock lever in the direction of 2.

- 3 Close the battery cover.**

Make sure that the connection cable comes out from the connection cable cover section.

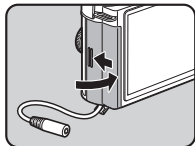

- 4 Connect the DC coupler and the AC adapter.**

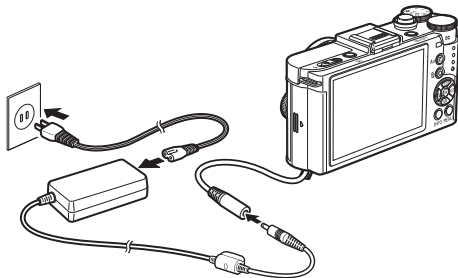

- 5 Connect the AC adapter to the AC plug cord, and plug the cord into the power outlet.**

### Caution

- Make sure that the camera is turned off before connecting or disconnecting the AC adapter.
- Make sure that connections are secure between the terminals. The memory card or data may be corrupted if the connection to the power supply is lost while the card is being accessed.
- After removing the DC coupler, return the connection cable cover to its original position.
- Be sure to read the manual of the AC adapter kit before using the AC adapter.

## Inserting a Memory Card

This camera uses a commercially available SD Memory Card, SDHC Memory Card, or SDXC Memory Card. An SD Memory Card with a built-in wireless LAN (Eye-Fi card) can also be used. (In this manual, these cards are referred to as memory cards.)

**1** Make sure that the camera is turned off.

**2** Slide the card cover in the direction of ①.

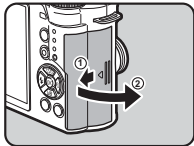

**3** Insert the card all the way with the memory card label facing toward the monitor. Push the memory card in once to remove.

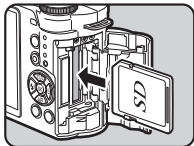

**4** Close the card cover, and slide it in the direction of ④.

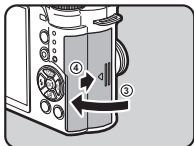

### ⚠ Caution

- Do not remove the memory card while the card access lamp is lit.
- If the card cover is opened while the power is on, the camera turns off. Do not open the cover while the camera is in use.
- Use this camera to format (initialize) a memory card that is unused or has been used on other devices. (p.27)
- Use a high-speed memory card when recording movies. If the write speed cannot keep up with the recording speed, the writing may stop during recording.

## Initial Settings

Turn the camera on and make the initial settings

### 2

### Getting Started

## Turning the Camera On

### 1 Press the power switch.

Press the switch again to turn off the camera.

The first time the camera is turned on after purchase, the [Language/言語] screen appears.

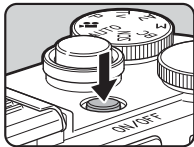

### Memo

- The power automatically turns off when you do not perform any operations within a set period of time. (Default setting: 1min.) You can change the setting in [Auto Power Off] of the  menu.

## Setting the Display Language

### 1 Use to select the desired language and press .

The [Initial Setting] screen appears in the selected language. Proceed to Step 6 if  (Hometown) does not need to be changed.

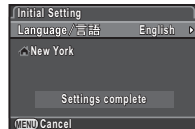

### 2 Press to move the frame to and press .

The [ Hometown] screen appears.

### 3 Use to select a city.

Use  to change the region. Refer to "List of World Time Cities" (p.84) for cities that can be selected as a hometown.



### 4 Press to select [DST] (daylight saving time), and use to select or .

### 5 Press .

The camera returns to the [Initial Setting] screen.

### 6 Press to select [Settings complete] and press .

The [Date Adjustment] screen appears.



## Setting the Date and Time

- 1 Press **▶**, and use **▲▼** to select the date format.

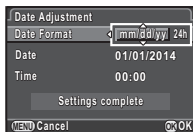

- 2 Press **▶**, and use **▲▼** to select 24h or 12h.

- 3 Press **OK**.

The frame returns to [Date Format].

- 4 Press **▼**, and then press **▶**.

The frame moves to the month if the date format is set to [mm/dd/yy].

- 5 Use **▲▼** to set the month.

Set the day, year and time in the same manner.

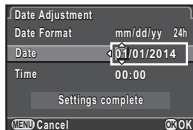

- 6 Press **▼** to select [Settings complete] and press **OK**.

The camera switches to capture mode and is ready to take a picture.

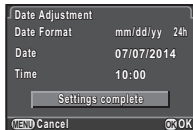

### Memo

- You can change the language and date and time settings from the **1** menu. (p.18)

## Formatting a Memory Card

**4**

- 1 Press **MENU**.

The **1** menu appears.

- 2 Use **DISK** to display **4** menu.

- 3 Use **▲▼** to select [Format] and press **▶**.

The [Format] screen appears.

- 4 Press **▲** to select [Format] and press **OK**.

Formatting starts. When formatting is completed, the screen that was displayed before selecting the menu appears again.

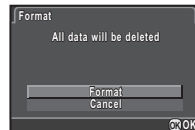

### Caution

- Do not remove the memory card while formatting, or the card may be damaged.
- Formatting deletes all data, both protected and unprotected.

### Memo

- When a memory card is formatted, the volume label "Q-S1" is assigned to the card. When the camera is connected to a computer, the memory card is recognized as a removable disk with the name "Q-S1".

**2**

Getting Started

## Basic Shooting Operation

Take pictures in **AUTO** mode in which the camera automatically selects the optimal capture mode.

- 1 Remove the front lens cap by pushing the top and bottom portions as indicated in the illustration.

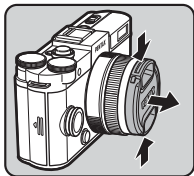

- 2 Turn the camera on.
- 3 Set the mode dial to **AUTO**.

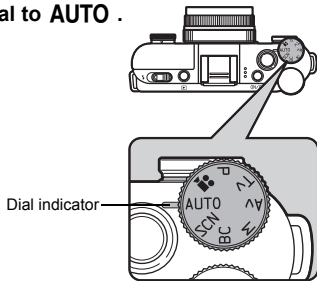

The selected capture mode is displayed on the monitor (Guide Display).



- 4 View the subject on the monitor.
- 5 When using a zoom lens, turn the zoom ring to the right or left to adjust the composition of the image.

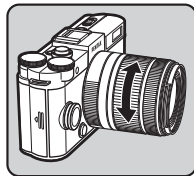

- 6 Position the subject inside the AF frame and press the shutter release button halfway.

The AF frame turns green and you will hear a beep when the subject comes into focus.



AF frame

➤ Setting the Sound Effects (p.18)

- 7 Press the shutter release button fully.

The captured image is displayed on the monitor (Instant Review).

### Available operations

- Deletes the image.
- Saves the RAW image.

➤ Setting the display for Instant Review (p.16)

## Reviewing Images

Review the captured image on the monitor.





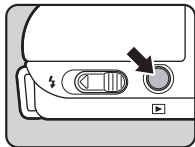







### 1 Press .

The camera enters playback mode and the most recently captured image is displayed (single image display).



### 2 Review the captured image.

#### Available operations

	Displays the previous image.
	Displays the next image.
	Deletes the image.
 to the right	Magnifies the image (up to 16×). Use     to change the area to display. Press  to return the display area to the center.
 to the left	Switches to the thumbnail display. (p.53)
	Saves the RAW image (only when a JPEG image was taken and the data remains in the buffer).
	Changes the type of information displayed. (p.11)
	Displays the playback mode palette. (p.52)









### Memo

- When  RAW is displayed on the monitor, the JPEG image that was just taken can also be saved in RAW format (Save RAW Data).

## Selecting the Appropriate Capture Mode

Select the capture mode that suits the subject and shooting conditions.

The following capture modes are available on this camera.

Capture Mode	Application	Page
<b>AUTO</b> (Auto Picture modes)	Automatically selects the optimal capture mode from  (Standard),  (Portrait),  (Landscape),  (Macro),  (Night Scene Portrait),  (Sunset),  (Blue Sky) or  (Forest).	p.28
<b>SCN</b> (Scene modes)	Offers you various scene modes to choose from.	p.30
<b>BC</b> (Blur Control mode)	Enables you to create a picture that looks as if it was taken with a wide-open aperture and shallow depth of field, by shooting multiple images with different focus positions and merging them into a single image.	p.31
<b>P/Tv/Av/M</b> (Exposure modes)	Changes the shutter speed and aperture value.	p.32
 (Movie mode)	Records a movie.	p.34











### Memo

- The functions that can be set vary depending on the capture mode. Refer to "Restrictions on Each Capture Mode" (p.71) for details.











## Scene Modes

- Set the mode dial to **SCN**.  
The scene mode selection screen appears.
- Use **▲▼◀▶** to select a scene mode.



	<b>Portrait</b>	For capturing portraits. Reproduces a healthy and bright skin tone.
	<b>Landscape</b>	For capturing landscape views. Reproduces the vivid green of trees.
	<b>Macro</b>	For capturing tiny objects at close focus range like flowers, coins, jewelry, and more.
	<b>Moving Object</b>	For capturing images of fast moving subjects.
	<b>Night Scene Portrait</b>	For capturing images of people in low light conditions, such as dusk or at night.
	<b>Sunset</b>	For capturing sunrises or sunsets in beautiful, vivid color.
	<b>Blue Sky</b>	For capturing images of blue sky. Produces a more impressive deep blue.
	<b>Forest</b>	Enhances colors of trees and sunbeams through foliage and produces a vivid color image.
	<b>Night Scene</b>	Used for shooting at night.
	<b>Night Scene HDR</b>	Takes three consecutive images at three different exposure levels to create a single composite image with them.
	<b>Night Snap</b>	For taking snapshots in poorly lit place.



 <b>HDR</b>	Captures 3 images to generate a single HDR image and provides a wider dynamic range.
 <b>Quick Macro</b>	For quick capture of tiny objects at close focus range.
 <b>Food</b>	For capturing images of food. Saturation will be rather high to make food look appetizing.
 <b>Pet</b>	For capturing moving pets.
 <b>Kids</b>	For capturing moving kids. Reproduces healthy and bright skin tone.
 <b>Surf &amp; Snow</b>	For capturing images of dazzling backgrounds, such as snowy mountains.
 <b>Backlight Silhouette</b>	Produces a silhouette image of subject in backlight condition.
 <b>Candlelight</b>	For capturing scenes in candlelight.
 <b>Stage Lighting</b>	For capturing moving subjects in poorly lit place.
 <b>Museum</b>	For capturing images in places where a flash is prohibited.

### 3 Press .

#### **Memo**

- You can change the scene mode from the control panel or the 1 menu.

## Blur Control Mode

### 1 Set the mode dial to BC.



### 2 Use to adjust the level of blur.

Check the blur effect in the image by viewing it in playback mode.



#### **Caution**

- The Blur Control mode is available only when an AF lens is used. (p.74)
- Do not move the camera while taking a picture.
- Some functions cannot be used in this mode. (p.71)
- The blur effect may not turn out as well as expected for the following situations and objects:
  - When the contrast is low overall
  - Fountains and other objects that change color or shape constantly
  - Moving objects
  - Small objects
  - Objects at the edge of the screen
  - Backlit scenes
  - When a special filter is used
  - Far-off objects

## Exposure Modes

✓: Available #: Restricted X: Not available

Mode	Change Shutter Speed	Change Aperture Value	Change Sensitivity	EV Compensation
<b>P</b> Program Automatic Exposure	# *1	# *1	✓	✓
<b>Tv</b> Shutter Priority Automatic Exposure	✓	X	✓	✓
<b>Av</b> Aperture Priority Automatic Exposure	X	✓	✓	✓
<b>M</b> Manual Exposure	✓	✓	✓ *2	X

\*1 You can set the value to be changed in [Green Button] of the  3 menu. (p.65)

\*2 When the sensitivity is set to [ISO AUTO], the camera operates in **TAv** (Shutter & Aperture Priority Automatic Exposure) mode.

## 1 Set the mode dial to **P**, **Tv**, **Av** or **M**.

▶ appears next to the value that can be changed.



## 2 Use to adjust the value.



## 3 In **M** mode, press (1), and use (2) to change the aperture value.

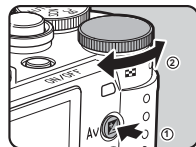



In **P/Tv/Av** mode, the exposure compensation value can be adjusted (from -3 to +3 EV in increments of 1/3 EV) by the same operation.



EV bar scale

### Available operations

-  Starts/ends adjusting the compensation value.
-  Resets the adjustment value to the default setting.

## 📌 Memo

- Exposure Bracketing shooting enables you to take pictures while automatically changing exposure. (p.42)
- A proper exposure may not be obtained with the selected shutter speed and aperture value when the sensitivity is set to a certain sensitivity value.
- In **M** mode, the difference from the proper exposure is displayed on the EV bar scale while the shutter speed or aperture value is adjusted.
- You can set the function of the **○** button for when the camera is in **M/TAv** mode. Set in [Green Button] of the **📷3** menu. (p.65)
- Sensitivity values higher than ISO 1600 are not available when the shutter speed is set to 2 seconds or slower in **Tv/M** mode.

## Bulb Shooting

**1** Set the mode dial to **M**.

**2** Turn **📷** to the left.  
**Bulb** appears after the slowest shutter speed.



**3** Press the shutter release button.

The shutter remains open as long as the shutter release button is kept pressed (up to 30 seconds).

**4** Take your finger off the shutter release button.  
Exposure ends.

## ⚠️ Caution





- Bulb shooting is available only when using a lens that has a lens shutter. (p.74)
- Some functions cannot be used in this mode. (p.71)

### Checking the Depth of Field (Preview)

When [Preview] is assigned to **○** in [Green Button] of the **📷3** menu, you can check the depth of field before taking pictures. (p.64)

## Movie Mode

### 1 Set the mode dial to .

Use  and  to adjust the exposure compensation value when [Exposure Setting] of the  1 menu is set to .

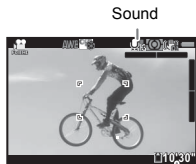

Recordable Time

### 2 Press the shutter release button halfway.

When [Focus Method] is set to **AF**, autofocus is performed.

### 3 Press the shutter release button fully.

Movie recording starts.

 blinks at the top left of the screen.

When [Focus Method] is set to **AF**, press  to perform autofocus.

### 4 Press the shutter release button fully.



Movie recording stops.

### Caution

- When recording a movie with sound, the camera operation sounds are also recorded.
- When recording a movie using any image processing function, such as Digital Filter, some frames may be omitted from the recorded movie file.
- If the internal temperature of the camera becomes high during recording, the recording may be terminated.

### Memo

- You can change the movie settings from the control panel or the  1 menu. (p.17)









- When [Focus Method] is set to **AF**, [Movie Continuous AF] in the  1 menu is set to [On], and an auto-focus lens other than the 06 TELEPHOTO ZOOM lens is used, autofocus continues even during recording.
- You can record a movie continuously up to 4 GB or 25 minutes. When the memory card is full, recording stops and the movie is saved.
- You can also use an optional remote control unit to record a movie. Select  in the Drive Mode screen. (p.42)

## Playing Back Movies

### 1 Display the movie to play back in single image display of the playback mode.



### Available operations

	Plays back/pauses a movie.
	Forwards a frame (when paused).
Press and hold 	Fast-forwards playback.
	Reverses a frame (when paused).
Press and hold 	Fast-reverses playback.
	Stops playback.
	Adjusts the volume (6 levels).
	Saves the displayed frame as a JPEG file (when paused).

### Memo

- In [Movie Edit] of the playback mode palette, movies can be divided or selected frames can be deleted. (p.62)

## Setting the Exposure

### Sensitivity



- 1 Press **▲** in standby mode.
- 2 Use **▲▼** to select an item.

<b>ISO AUTO</b>	Sets the range to be adjusted automatically. The upper limit can be changed.
<b>ISO</b>	Sets a fixed value between ISO 100 to ISO 12800.



- 3 Use **⏏** to change the value.
- 4 Press **OK**.

The camera returns to standby mode.

#### Memo

- Sets the adjustment steps for ISO sensitivity in [2. Sensitivity Steps] of the **C1** menu.
- Captured images may show more noise if a higher sensitivity is set. You can reduce image noise by using [High-ISO NR] of the **M2** menu.

<b>Auto</b>	Applies Noise Reduction at optimally calculated levels throughout ISO range.
<b>Low/High</b>	Applies Noise Reduction at constant chosen level throughout ISO range.

## AE Metering



Choose the part of the sensor to use for measuring brightness and determining exposure.

Set in the control panel or [AE Metering] of the **C1** menu.

<b>Multi-segment</b>	Meters the brightness in multiple different zones of the sensor. In backlit locations, this mode automatically adjusts exposure. In [4. Link AE and AF Point] of the <b>C1</b> menu, you can link the exposure and AF point in the focusing area.
<b>Center-weighted</b>	Meters the brightness with an emphasis on the center of the sensor. The sensitivity increases at the center and no automatic adjustment is performed even in backlit conditions.
<b>Spot</b>	Meters the brightness only within a limited area at the center of the sensor. Useful when the subject is small.

## Using the Built-in Flash



- 1 Press **◀** in standby mode.
- 2 Use **◀▶** to select an item.



	<b>Auto Flash Discharge</b>	Automatically measures the ambient light and determines whether to use the flash.
	<b>Auto Flash +Red-eye Reduction</b>	Discharges a pre-flash for red-eye reduction before an automatic flash.
	<b>Flash On</b>	Discharges a flash for each picture.
	<b>Flash On +Red-eye Reduction</b>	Discharges a pre-flash for red-eye reduction before the main flash.
	<b>Slow-speed Sync</b>	Sets to a slow shutter speed. Use this when shooting a portrait with the sunset in the background.
	<b>Slow-speed Sync+Red-eye</b>	Discharges a pre-flash for red-eye reduction before the main flash is discharged with Slow-speed Sync.
	<b>Trailing Curtain Sync</b>	Discharges a flash immediately before closing the shutter. Sets to a slow shutter speed. Captures moving objects as if they are leaving a light trail behind them.
	<b>Flash Off</b>	The flash is deactivated.

- 3 Press **▼**, and use to compensate the flash output.

Press **○** to reset the value.



- 4 Press **OK**.

The camera returns to standby mode.

- 5 Slide the flash pop-up switch.

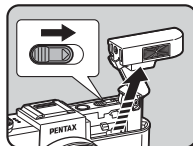

### ⚠ Caution

- Be sure to retract the built-in flash if not planning to use it. Be careful not to get your fingers pinched when retracting the flash.
- The built-in flash discharges even when retracted, which may cause vignetting to occur depending on the lens being used. If you do not want to let the built-in flash discharge while it is retracted, set [11. Flash When Retracted] in the **C2** menu.
- You cannot take pictures while the flash is being charged. If you want to take pictures while charging the flash, set [12. Release While Charging] in the **C2** menu.
- Depending on the lens being used, the use of the built-in flash may be limited. (p.74)

## Memo

- The flash modes that can be selected vary depending on the capture mode.

Capture Mode	Selectable Flash Mode
AUTO, SCN <sup>*1</sup>	⚡A, Ⓞ
BC	⚡A, ⚡A, ⚡, ⚡Ⓞ, Ⓞ
P, Av	⚡A, ⚡A, ⚡, ⚡Ⓞ, SLOW, SLOW, SLOW, Ⓞ
Tv	⚡A, ⚡A, ⚡, ⚡Ⓞ, ⚡, Ⓞ
M	⚡, ⚡Ⓞ, ⚡, Ⓞ

\*1 Fixed to Ⓞ for some SCN modes.

- The built-in flash is optimum for a subject at a distance from approx. 0.7 m to 5 m. Vignetting may occur when used at a distance closer than 0.7 m (this distance varies slightly depending on the lens being used and the sensitivity setting).

Sensitivity	Guide Number	Sensitivity	Guide Number
ISO 100	Approx. 4.9	ISO 1600	Approx. 20
ISO 200	Approx. 7	ISO 3200	Approx. 28
ISO 400	Approx. 10	ISO 6400	Approx. 40
ISO 800	Approx. 14	ISO 12800	Approx. 56

- For details on using an external flash, refer to "Functions when Using an External Flash" (p.76).

## Focusing

### Focus Method



Set [Focus Method] to **AF** or **MF** in the control panel or [AF/MF Settings] of the 1 menu.

### Memo

- In **AF** mode, when the subject is in a dark location, the AF assist light is used when the shutter release button is pressed halfway. To change the setting, set [AF Assist Light] in [AF/MF Settings] of the 1 menu.
- You can use the button to focus on the subject. In that case, the autofocus by pressing the shutter release button halfway is disabled. (p.64)
- In **AF** mode, focus ring operations can be disabled to prevent accidentally moving the lens focus ring and causing the picture to be out of focus. Set in [10. Focus Ring in AF Mode] of the **C2** menu.

## Setting the Autofocus Method



You can choose from the following autofocus methods.

<b>Face Detection</b>	Detects and tracks faces of people. The main face detection frame for AF and AE is displayed in yellow. Autofocus continues while the shutter release button is pressed halfway.
<b>Tracking</b>	Tracks the subject in focus. Autofocus continues while the shutter release button is pressed halfway.
<b>Multiple AF Points</b>	Sets the focusing area to the desired area. The sensor is divided into 49 areas (7 horizontal by 7 vertical), and you can select a wider or narrower focusing area by using 25, 9, or just 1 of those 49 areas available.
<b>Select</b>	Sets the focusing area by the number of pixels.
<b>Spot</b>	Sets the focusing area to a limited area at the center.

### Memo

- The autofocus method is fixed to or depending on the capture mode. (p.71) and cannot be selected in mode.
- In **AF** mode, you can take pictures only when the subject is in focus. To take pictures when the subject is not in focus, set [8. AF Release Options] to [Release-priority] in the **C2** menu.
- Selecting , , or enables to lock the focus and recompose the picture while the shutter release button is pressed halfway.

## Selecting the Desired Focusing Area

You can set the position and size of the autofocusing area (AF area).

- 1 Set [Autofocus Method] to or .
- 2 Press **MENU**.  
The camera is in standby mode.
- 3 Press **OK**.
- 4 Select the AF area.



### Available operations

- |  |   |
|--|---|
|  | Changes the position of the AF area.                          |
|  | When  is selected: increases/reduces the size of the AF area. |
|  | Returns the AF area to the center.                            |

- 5 Press **OK**.  
The AF area is set.



## Adjusting the Focus Manually (Manual Focus)

**1** Set [Focus Method] to **MF**.

**2** Press **MENU**.

The camera is in standby mode.

**3** While viewing the monitor, turn the focus ring.

The shutter is released by pressing the shutter release button fully even if the subject is not in focus.

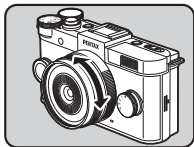

### Focusing with the Image Magnified



The image in the center of the monitor is automatically magnified when the focus ring is turned.

**1** Select [MF Autozoom] in [AF/MF Settings] of **1** menu.

**2** Select the magnification level and press **OK**.

**3** Press **MENU** twice.

The camera is in standby mode.

**4** Turn the focus ring.

The image on the monitor is magnified.



#### Available operations



Magnifies the image (x2, x4, or x6).



Changes the area to display.  
Press **O** to change the display area to the center.



Switches between magnified view and original-size view.

#### Memo

- When [Focus Peaking] is set to [On] in the control panel or [AF/MF Settings] of the **1** menu, the outline of the subject in focus is emphasized and makes it easier to check the focus. This function works in both **AF** and **MF** modes.

## Setting the Drive Mode



You can choose from the following drive modes.

<input type="checkbox"/> Single Frame Shooting	Normal capture mode
<b>Continuous Shooting (Hi)</b>	Pictures are taken continuously while the shutter release button is kept pressed. You can capture up to approx. 5 frames at once. Not available when [File Format] is set to [RAW] or [RAW+].
<b>Continuous Shooting (Lo)</b>	You can capture up to approx. 100 frames at once.
<b>Self-timer (12 sec.)</b>	The shutter is released about 12 seconds after the shutter release button is pressed.
<b>Self-timer (2 sec.)</b>	The shutter is released about 2 seconds after the shutter release button is pressed.
<b>Remote Control</b>	The shutter is released immediately after the shutter release button on the remote control unit is pressed.
<b>Remote Control (3 sec. delay)</b>	The shutter is released about 3 seconds after the shutter release button on the remote control unit is pressed.
<b>Remote Continuous Shooting</b>	Continuous shooting starts when the shutter release button on the remote control unit is pressed, and ends when the shutter release button is pressed again.
<b>Exposure Bracketing</b>	Takes three consecutive images at three different exposure levels. The images are saved with each release in the order of standard exposure, underexposure and overexposure.
<b>Exposure Bracket+ Remote Ctrl</b>	Enables Exposure Bracketing shooting with remote control.
<b>Multi-exposure</b>	Creates a composite picture by taking multiple images and merging them into a single image.

<b>Self-timer+ Multi-exposure</b>	Enables Multi-exposure shooting with the self-timer.
<b>Remote Control+ Multi-exposure</b>	Enables Multi-exposure shooting with remote control.
<b>Interval Shooting</b>	Takes still images at a set interval from a set time.
<b>Interval Movie Record</b>	Takes still images at a set interval from a set time and saves them as a single movie file. Available only in  mode.

### ⚠ Caution

- The Drive Mode settings that can be set vary depending on the capture mode. (p.71)

### 📝 Memo

- The Drive Mode setting is saved even after the power is turned off. If [Drive Mode] is set to [Off] in [Memory] of the 3 menu, the setting returns to Single Frame Shooting when the power is turned off. (p.67)
- The Shake Reduction function is automatically turned off when Self-timer or Remote Control is selected. If you do not want to turn it off, set [16. Auto SR Off] in the 3 menu.

## Continuous Shooting

- 1 Press **▶** in standby mode.  
The Drive Mode screen appears.

- 2 Use **◀▶** to select  and press **▼**.



- 3 Use **◀▶** to select  or  and press **OK**.  
The camera returns to standby mode.

### ⚠ Caution

- The number of recordable frames varies according to the set aspect ratio.
- You cannot take pictures while the flash is being charged. If you want to take pictures while the flash is charging, set [12. Release While Charging] in the **C2** menu.

### 📝 Memo



- The focus position is locked in the first frame.

## Self-timer Shooting

- 1 Press **▶** in standby mode.  
The Drive Mode screen appears.

- 2 Use **◀▶** to select  and press **▼**.



- 3 Use **◀▶** to select  or  and press **OK**.  
The camera returns to standby mode.

- 4 Press the shutter release button halfway → fully.  
The self-timer lamp blinks.  
The shutter will be released about 12 seconds or 2 seconds.

## Remote Control Shooting

- 1 Press **▶** in standby mode.  
The Drive Mode screen appears.

- 2 Use **◀▶** to select **i** and press **▼**.



- 3 Use **◀▶** to select **i**, **i<sub>as</sub>** or **i** and press **OK**.  
The camera returns to standby mode.  
The self-timer lamp blinks.

- 4 Press the shutter release button halfway.

- 5 Point the remote control unit towards the remote control receiver on the front or back of the camera, and press the shutter release button on the remote control unit.

### Memo

- The maximum operating distance of the remote control unit is approx. 4 m from the front of the camera and approx. 5 cm from the back of the camera.
- To use the remote control unit to adjust the focus, set in [9. AF with Remote Control] of the **C2** menu.
- When using the Remote Control Waterproof O-RC1, the autofocus system can be operated with the  $\frac{1}{\infty}$  button. The **Fn** button cannot be used.

## Exposure Bracketing

- 1 Press **▶** in standby mode.  
The Drive Mode screen appears.

- 2 Use **◀▶** to select **EB** and press **▼**.



- 3 Use **◀▶** to select **EB** or **EB** and press **▼**.

- 4 Set the bracket value.

The bracket value can be set in increments of 1/3 EV.



### Available operations





	Changes the bracket value.
	Adjusts the exposure compensation value.
	Resets the adjustment value to the default setting.

- 5 Press **OK**.  
The camera returns to standby mode.

### Memo

- You can set the bracketing order in [5. Bracketing Order] of the **C1** menu.

## Multi-exposure

- 1 Press  $\blacktriangleright$  in standby mode.**  
The Drive Mode screen appears.
- 2 Use  $\blacktriangleleft\blacktriangleright$  to select  and press  $\blacktriangledown$ .**
- 3 Use  $\blacktriangleleft\blacktriangleright$  to select ,  or , and press  $\blacktriangledown$ .**
- 4 Use  $\blacktriangleleft\blacktriangleright$  to select the number of shots.**  
Select from 2 to 9 shots.  
Set [Auto EV Adjustment] to  to adjust exposure automatically according to the number of shots.
- 5 Press **OK**.**  
The camera returns to standby mode.
- 6 Press the shutter release button to start shooting.**  
Instant Review is displayed.



### Available operations

- |   |   |
|---|---|
|  | Discards pictures taken up to that point and takes pictures again from the first picture. |
| <b>MENU</b>   | Saves pictures taken up to that point and returns to standby mode.                        |

After the set number of pictures are taken, the camera returns to normal capture mode.

## Interval Shooting

- 1 Press  $\blacktriangleright$  in standby mode.**  
The Drive Mode screen appears.
- 2 Use  $\blacktriangleleft\blacktriangleright$  to select  and press  $\blacktriangledown$ .**
- 3 Use  $\blacktriangle\blacktriangledown\blacktriangleleft\blacktriangleright$  to set the shooting conditions.**

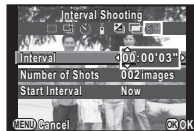

<b>Interval</b>	For taking two or more pictures, set the wait time until the next picture is taken from 3 seconds to 24 hours.
<b>Number of Shots</b>	Set the number of shots to be taken from 2 to 999.
<b>Start Interval</b>	Select whether to take the first picture now or at a set time.
<b>Start Time</b>	When [Start Interval] is set to [Set Time], set the time at which to start shooting.

- 4 Press **OK** to finish setting.**  
The camera returns to standby mode.
- 5 Press the shutter release button to start shooting.**  
When [Start Interval] is set to [Now], the first picture is taken. When set to [Set Time], shooting starts at the set time. To cancel shooting, press **MENU**.  
After the set number of pictures are taken, the camera returns to normal capture mode.

### Memo

- The focus position is locked in the first frame.

## Interval Movie Record

In  mode, you can use the Interval Movie Record feature to take still pictures at a set interval from a set time and save them as a single movie file (Motion JPEG, file extension: .AVI).

### 1 Set the mode dial to and press .

The Drive Mode screen appears.

### 2 Use and to select and press .

### 3 Use to set the shooting conditions.



<b>Interval</b>	Select from 3 sec., 5 sec., 10 sec., 30 sec., 1min., 5 min., 10 min., 30 min., or 1 hr.
<b>Recording Time</b>	Set the time at which to start and stop recording from 12 seconds to 99 hours. The time that can be set varies depending on [Interval] setting.
<b>Start Interval</b>	Select whether to take the first picture now or at a set time.
<b>Start Time</b>	When [Start Interval] is set to [Set Time], set the time at which to start shooting.

### 4 Press to finish setting.

The camera returns to standby mode.

### 5 Press the shutter release button to start shooting.

When [Start Interval] is set to [Now], the first picture is taken.

Instant Review is displayed, and then the monitor turns off. After the set number of pictures are taken, the camera returns to normal movie recording mode.

## Setting a File Format

### Still Pictures



Set the file format for still pictures in the control panel or [Image Capture Settings] of the 1 menu.

Aspect Ratio	, , ,
File Format	JPEG, RAW, RAW+
JPEG Recorded Pixels	, ,
JPEG Quality	★★★, ★★, ★

#### ⚠ Caution

- When [File Format] is set to [RAW] or [RAW+], some functions are not available. [RAW] and [RAW+] cannot be selected for some capture modes. (p.71)

#### 📝 Memo

- When [File Format] is set to [RAW+], a JPEG image and a RAW image with the same file number are saved at the same time.
- By assigning [One Push File Format] to , you can take pictures with a different file format setting only when the button is pressed. (p.64)

### Movies



Set the file format for movies in the control panel or [Movie Capture Settings] of the 1 menu.

Recorded Pixels	, ,
Framerate	30 fps, 25 fps, 24 fps

## Adjusting the Color and Brightness of Images

### White Balance



#### 1 Press in standby mode.

The White Balance setting screen appears.

#### 2 Use to select an item.

When is selected, press and use to select , , or .



	White Balance	Color Temperature
	Auto	Approx. 4,000 to 8,000K
	Daylight	Approx. 5,200K
	Shade	Approx. 8,000K
	Cloudy	Approx. 6,000K
	Fluorescent - Daylight Color	Approx. 6,500K
	Fluorescent - Daylight White	Approx. 5,000K
	Fluorescent - Cool White	Approx. 4,200K
	Fluorescent - Warm White	Approx. 3,000K
	Tungsten	Approx. 2,850K
	Flash	Approx. 5,400K
	Color Temperature Enhancement	—
	Manual 1 to 3	—

Proceed to Step 5 if you do not need to fine-tune the white balance.

**3** Press **[M]**.

The fine-tuning screen appears.

**Available operations**

▲▼	Adjust: Green-Magenta
◀▶	Adjust: Blue-Amber
○	Resets the adjustment value to the default setting.

**4** Press **[OK]**.

The screen of Step 2 reappears.

**5** Press **[OK]**.

The camera returns to standby mode.

**Memo**

- You can set the white balance for when the flash discharges in [6. WB When Using Flash] of the **C1** menu.

**Adjusting the White Balance Manually**

You can measure the white balance at a selected location.

**1** Select **[1]** in Step 2 on p.45 and press **▼**.**2** Use **◀▶** to select **[1]** to **[3]**.**3** Under the light you wish to measure the white balance of, select a white area as the subject, and press the shutter release button fully.

Adjust the white balance as necessary.

[The operation could not be completed correctly] appears when measuring is unsuccessful. Press **[OK]** to remeasure the white balance.

**4** Press **[OK]**.

The camera returns to standby mode.

**Memo**

- You can copy the white balance settings of an image captured with this camera and save them as **[1]** to **[3]** in [Save as Manual WB] of the playback mode palette. (p.52)



## Adjusting Brightness

### Highlight Correction/Shadow Correction

Expands the dynamic range and enables a wider range of tones by the CMOS sensor and reduces the occurrence of overexposed/underexposed areas.

Set in the control panel or [D-Range Settings] of the 2 menu.



#### Caution

- When the sensitivity is set to ISO 100, [Highlight Correction] cannot be set to [On].

### HDR Capture

Takes three consecutive images at three different exposure levels to create a single composite image with them.

Set in the control panel or [HDR Capture] of the 1 menu.

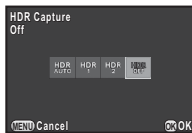



#### Caution

- This function cannot be used in some capture modes or in combination with some other functions. (p.71)

- During HDR Capture, multiple images are combined together to create a single image, so it will take time to save the composite image.

#### Memo

- Specific HDR settings are used and HDR Capture cannot be set when  or  of the **SCN** mode is selected.

## Controlling the Image Finishing Tone

When you want to take images with a slightly different style, you can set the desired picture style before you start shooting. The following functions are available. Try out the various settings, and find the shooting method that best suits your style.

<b>Custom Image</b>	Sets the image finishing tone such as [Bright] and [Portrait].
<b>Digital Filter</b>	Takes images using various filters.
<b>Smart Effect</b>	Takes images using various effects.

### Custom Image



- 1 Select [Custom Image] in the control panel, and press **OK**.

The Custom Image setting screen appears.

- 2 Use **▲▼◀▶** to select an image finishing tone.



Bright  
Natural  
Portrait  
Landscape  
Vibrant  
Radiant

Muted  
Bleach Bypass  
Reversal Film  
Monochrome  
Cross Processing

Proceed to Step 6 if you do not need to change the parameters.

- 3 Press **OK**.

The parameter setting screen appears.

- 4 Use **▲▼** to select a parameter.



#### Available operations

- Adjusts the values.
- Switches between [Sharpness] and [Fine Sharpness]. (Not available in mode).
- Resets the adjustment value to the default setting.

- 5 Press **OK**.

The screen of Step 2 reappears.

- 6 Press **OK**.

- 7 Press **MENU**.

The camera returns to standby mode.

## Saving the Cross Processing Settings of a Captured Image

The outcome of Cross Processing for Custom Image and Smart Effect varies each time a picture is taken. If you take a cross processed image that you like, you can save the Cross Processing settings used in the image so that you can load and use the same settings again.

### 1 Press **▼** in single image display of playback mode.

The playback mode palette appears.

### 2 Use **▲▼◀▶** to select and press **OK**.

The camera searches for cross processed images starting from the most recent image taken.

[No cross processed image] appears if there are no cross processed images.

### 3 Use to select a cross processed image.



### 4 Use **▲▼** to select the “Favorite” number 1, 2 or 3 to save the settings, and press **OK**.

The settings of the selected image are saved as your “Favorite” settings.

#### Memo

- Saved cross processing settings can be loaded by selecting [Cross Processing] in [Custom Image], and selecting one of the Favorite settings 1 to 3 for the parameter.

## Digital Filter



### 1 Select [Digital Filter] in the control panel, and press **OK**.

The Digital Filter setting screen appears.

### 2 Use **▲▼◀▶** to select a filter.

Select [No Filter] to not shoot with a digital filter.



Toy Camera  
High Contrast  
Shading  
Tone Expansion  
Invert Color  
Extract Color

Unicolor Bold  
Water Color  
Posterization  
Slim  
Fish-eye

Proceed to Step 6 if you do not need to change the parameters.

### 3 Press .

The parameter setting screen appears.

### 4 Use **▲▼** to select a parameter, and use **◀▶** to adjust the value.



**5** Press **OK**.  
The screen of Step 2 reappears.

**6** Press **OK**.

**7** Press **MENU**.  
The camera returns to standby mode.

### ⚠ Caution

- This function cannot be used in some capture modes or in combination with some other functions. (p.72)
- Depending on the filter used, it may take longer to save images.

### 📝 Memo

- Images can be processed with digital filters in playback mode. (p.59)

## Saving Frequently Used Functions to the Quick Dial



One of the following functions can be saved in the quick dial located on the front side of the camera. You can save frequently used functions to the quick dial to easily change the settings.

Smart Effect  
Aspect Ratio  
Focus Method

Focus Peaking  
ND Filter

**1** Select **[Quick Dial]** in **Q3** menu and press **▶**.  
The **[Quick Dial]** screen appears.

**2** Press **▶**, and use **▲▼** to select the function to save.

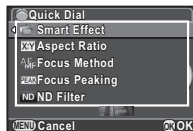

**3** Press **OK**, and then press **▼**.

**4** Use **▲▼** to select the position 1-4 of the quick dial.



**5** Use **◀▶** to select the desired setting.  
Select a Smart Effect setting from those listed below.



Brilliant Color  
Unicolor Bold  
Vintage Color  
Antique  
Warm Fade

Tone Expansion  
Bold Monochrome  
Vibrant Color Enhance  
Faded Color  
USER 1 to 3

**6** Press **OK**.  
The screen of Step 4 reappears.  
Repeat Steps 4 to 6 to save the settings to the other positions.

## 7 Press **MENU** twice.

The camera returns to standby mode.

### **Memo**

- The shooting settings of your favorite images can be saved in [USER1 - 3] of [Smart Effect]. You can quickly shoot images with your favorite settings by using the quick dial. (p.66)

## Loading Settings for Taking Pictures

You can take pictures with the settings saved in the quick dial. When you use the quick dial to take pictures, priority is given to the settings saved in the quick dial.

- 1 In standby mode, turn the quick dial to select the position 1 to 4.

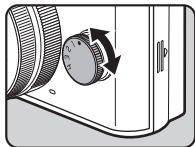

- 2 Shoot.

- 3 After taking pictures, return the quick dial to the position 0.

The camera returns to the original settings.

### **Caution**

- You cannot use the menus to change the settings when taking pictures with the quick dial. To change the settings of the quick dial, save other settings again.

## Shooting with Smart Effect

- 1 Save [Smart Effect] for [Quick Dial].
- 2 In standby mode, turn the quick dial to select the position 1 to 4.
- 3 Press **▼** to change the parameters.  
The parameter setting screen appears.
- 4 Use **◀▶** to change the parameters.



- 5 Press **OK**.

The camera returns to standby mode.

### **Caution**









- This function cannot be used in combination with some other functions. (p.73)





## Playback Mode Palette Items

Playback functions can be set from the playback mode palette as well as the 1 menu (p.17).

Press  in single image display of the playback mode to display the playback mode palette.



Item	Function	Page
 <b>Image Rotation</b> *1	Changes the rotation information of images.	p.55
 <b>Digital Filter</b> *1	Processes images with digital filters.	p.59
 <b>Red-eye Edit</b> *1 *2	Corrects images of a subject captured with red eyes.	p.59
 <b>Resize</b> *1 *2	Changes the number of recorded pixels of the image.	p.58
 <b>Cropping</b> *1 *2	Crops out only the desired area of an image.	p.58
 <b>Index</b>	Joins a number of images together and creates an index image with them.	p.61
 <b>Protect</b>	Protects images from being accidentally erased.	p.68
 <b>Slideshow</b>	Plays back images one after another.	p.55
 <b>Save as Manual WB</b> *1	Saves the white balance settings of the captured image as Manual White Balance.	p.46

Item	Function	Page
 <b>Save Cross Processing</b>	Saves the settings used for an image captured in Cross Processing mode of Custom Image or Smart Effect as your "Favorite" settings.	p.49
 <b>Save Smart Effect</b> *1	Saves the shooting settings of your favorite image to the quick dial.	p.66
 <b>RAW Development</b> *3	Develops RAW images into JPEG format.	p.63
 <b>Movie Edit</b> *4	Divides a movie or deletes unwanted segments.	p.62
 <b>Eye-Fi Image Transfer</b>	Transfers selected images wirelessly using an optional Eye-Fi card.	p.70

\*1 Not available when a movie is displayed.

\*2 Not available when a RAW image is displayed.

\*3 Available only when a RAW image is saved.

\*4 Available only when a movie is displayed.

## Changing the Playback Method

### Displaying Multiple Images

You can display 4, 9, 30 or 56 thumbnail images at the same time.

- 1 Turn  to the left in playback mode.  
The multi-image display screen appears.





#### Available operations

 Moves the selection frame.

 Shows the display style selection screen.



 Deletes the selected images.

- 2 Press .
- The selected image appears in single image display.

### Deleting Selected Images



- 1 Press  in Step 1 of “Displaying Multiple Images”.
- 2 Select the images to delete.





#### Available operations

 Moves the selection frame.

 Confirms/cancels the selection of the image to delete.

 Shows the selected image in single image display.  
Use  to select a different image.

- 3 Press .
- The delete confirmation screen appears.
- 4 Select [Select & Delete] and press .

#### Memo

- You can select up to 100 images at a time.
- Protected images cannot be selected.



## Displaying Images by Folder

- 1 Turn  to the left in Step 1 of “Displaying Multiple Images”.

The folder display screen appears.

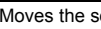

### Available operations

- |   |                              |
|---|------------------------------|
|   | Moves the selection frame.   |
|    | Deletes the selected folder. |

- 2 Press **OK**.

The images in the selected folder are displayed.

## Deleting a Folder

- 1 Select a folder to delete in Step 1 of “Displaying Multiple Images by Folder”, and press .

The delete confirmation screen appears.

- 2 Select **[Delete]** and press **OK**.

The selected folder and all the images in it are deleted. When there are protected images in the folder, select **[Delete all]** or **[Leave all]**.

## Displaying Images by Shooting Date

Images are grouped and displayed by shooting date.

- 1 Select **INFO** in Step 1 of “Displaying Multiple Images”.

The display style selection screen appears.

- 2 Select **[Calendar Filmstrip Display]**.





Number of images shot on this date



Shooting date

Thumbnail

### Available operations

- |  |   |
|--|---|
|               | Selects a shooting date.                              |
|               | Selects an image taken on the selected shooting date. |
|  to the right | Shows the selected image in single image display.     |
|               | Deletes the selected image.                           |

- 3 Press **OK**.

The selected image appears in single image display.

### Caution

- Calendar Filmstrip Display is not available when there are more than 100,000 image files saved on the memory card.







## Playing Back Images Continuously (Slideshow)

### 1 Select in the playback mode palette.

Slideshow starts.

#### Available operations

	Pauses/resumes playback.
	Displays the previous image.
	Displays the next image.
	Stops playback.

After all images are played back, the camera returns to the single image display.

### Memo

- You can change the [Display Duration], [Screen Effect], [Repeat Playback] and [Auto Movie Playback] settings for slideshow in [Slideshow] of the  1 menu. Slideshow can be started from the Slideshow setting screen.

## Displaying Rotated Images

When you take pictures with the camera held vertically, the image rotation information is saved when shooting. During playback, the image is automatically rotated based on the rotation information when [Auto Image Rotation] in the  1 menu is set to [On].

The rotation information of an image can be changed by following the procedure below.

### 1 Display the image to edit in single image display.

### 2 Select in the playback mode palette.

The selected image is rotated in 90° increments and the four thumbnail images are displayed.

### 3 Use to select the desired rotation direction and press .

The image rotation information is saved.



### Caution

- When [14. Save Rotation Info] is set to [Off] in the **C3** menu, the image rotation information is not saved when shooting.
- You cannot change the rotation information for the following images and situation.
  - Protected images
  - Images without a rotation information tag
  - When [Auto Image Rotation] is set to [Off] in the  1 menu
- Movie files cannot be rotated.

## Connecting the Camera to an AV Device

You can connect the camera to a TV or other device with a video input terminal or HDMI input terminal and play back images. Have a cable according to the terminal of the device to which you connect.

Terminal of AV Device	Cable Used
Video terminal	AV cable I-AVC7 (optional)
HDMI terminal	HDMI cable with an HDMI terminal (Type D) (commercially available)

- 1 Turn the AV device and camera off.
- 2 Open the terminal cover of the camera, and connect the cable to either the PC/AV terminal or HDMI terminal.

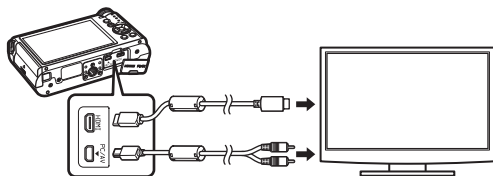

- 3 Connect the other end of the cable to the input terminal on the AV device.
- 4 Turn the AV device and camera on.

The camera turns on in video mode or HDMI mode, and the camera information is displayed on the screen of the connected AV device.

### ⚠ Caution

- When using the video output, images are output at normal resolution regardless of the resolution supported by the AV device. To output HD video, use the HDMI output or transfer to and play back on a computer.
- While the camera is connected to an AV device, nothing is displayed on the camera monitor. Also, you cannot adjust the volume on the camera. Adjust the volume on the AV device.
- You cannot output both composite and HDMI video signals at the same time.

### 📌 Memo

- Check the operating manual of the AV device and select a suitable input terminal for connecting the camera.
- If you intend to use the camera continuously for a long period, use of the AC adapter kit (optional) is recommended.
- When the hometown is set at the time of initial setting (p.26), the video output format is also set in accordance with that region. When you set [Time Setting] to [Destination] in [World Time] of the 1 menu, the video output setting changes to the video output format for that city. Depending on the country or region, images may fail to be played back with the set video output format. If this happens, change the setting in [Video Out] of [Interface Options] in the 2 menu. Refer to "List of World Time Cities" (p.84) for video output format for cities that can be selected as a hometown or destination.
- By default, the maximum resolution supported by both the AV device and camera is automatically selected. If it fails to play back images properly, change the setting in [HDMI Out] of [Interface Options] in the 2 menu.

## Connecting the Camera to a Computer

Connect the camera to a computer using the provided USB cable I-USB7.

- 1 Turn the computer on.
- 2 Turn the camera off.
- 3 Open the terminal cover of the camera, and connect the USB cable to the PC/AV terminal.

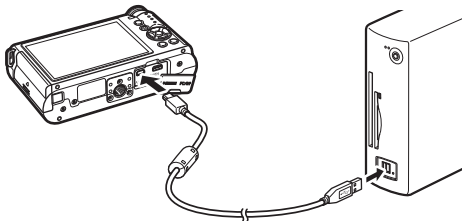

- 4 Connect the USB cable to the USB port of the computer.
- 5 Turn the camera on.

The camera is recognized as a removable disk.

If the "Q-S1" dialog appears when the camera is turned on, select [Open folder to view files] and click the OK button.

- 6 Save the captured images to the computer.
- 7 Disconnect the camera from the computer.

### Caution

- The camera cannot be operated while it is connected to a computer. To operate the camera, terminate the USB connection on the computer, then turn off the camera and remove the USB cable.

### Memo

- Refer to "Operating Environment for USB Connection and Provided Software" (p.85) for system requirements to connect the camera to a computer and to use the software.
- The USB connection mode when connecting the camera to a computer can be set in [USB Connection] of [Interface Options] in the  $\searrow$ 2 menu. Normally, you do not need to change the default setting ([MSC]).

## Editing and Processing Images

### Changing the Image Size

#### ⚠ Caution



- Only JPEG images captured with this camera can be resized or cropped.
- Images already resized or cropped to the minimum file size with this camera cannot be processed.

### Changing the Number of Recorded Pixels (Resize)

Changes the number of recorded pixels of the selected image, and saves it as a new file.

**1** Display the image to edit in single image display.

**2** Select  in the playback mode palette.  
The screen to select the recorded pixels appears.

**3** Use   to select the number of recorded pixels and press **OK**.

You can select one of the image sizes starting from one size smaller than that of the original image.



**4** Select **[Save as]** and press **OK**.

### Cropping Out Part of the Image (Cropping)

Crops out only the desired area of the selected image and saves it as a new file.

**1** Display the image to edit in single image display.

**2** Select  in the playback mode palette.

The cropping frame to specify the size and position of the area to crop appears on the screen.

**3** Specify the size and position of the area to crop by using the cropping frame.



#### Available operations



Changes the size of the cropping frame.



Moves the cropping frame.



Changes the aspect ratio.



Rotates the cropping frame (only when possible).

**4** Press **OK**.

**5** Select **[Save as]** and press **OK**.

## Removing the Red-eye Effect

You can correct images where the flash has caused the subject to appear with red eyes.

**1** Display the image to edit in single image display.

**2** Select  in the playback mode palette.  
[The operation could not be completed correctly] appears when red eyes cannot be detected on the camera.

**3** Select [Save as] and press .

### Caution

- The Red-eye Edit function can be used only for the JPEG images captured with this camera.

## Processing Images with Digital Filters

**1** Display the image to edit in single image display.

**2** Select  in the playback mode palette.  
The screen to select a filter appears.

**3** Use     to select a filter.

Use  to select a different image.



Base Parameter Adj	Posterization
Toy Camera	Slim
High Contrast	Fish-eye
Shading	Retro
Tone Expansion	Sketch
Invert Color	Miniature
Extract Color	Soft
Unicolor Bold	Starburst
Water Color	

Proceed to Step 6 if you do not need to change the parameters.

**4** Press .

The parameter setting screen appears.

## 5 Use ▲▼ to select a parameter, and use ◀▶ to adjust the value.

The parameters that can be set varies depending on the selected filter.



## 6 Press OK.

The save confirmation screen appears.

## 7 Select [Apply additional filter(s)] or [Save as] and press OK.

Select [Apply additional filter(s)] when you want to apply additional filters to the same image. The screen of Step 3 reappears.

### ⚠ Caution

- Only JPEG and RAW images captured with this camera can be edited with the digital filters.

### 📝 Memo

- Up to 20 filters, including a digital filter used during shooting (p.49), can be applied to the same image.

## Recreating Filter Effects

Retrieves the filter effects of a selected image and applies the same filter effects to other images.

## 1 Display a filter-processed image in single image display.

## 2 Select in the playback mode palette.

## 3 Select [Recreating filter effects] and press OK.

The filter effects used for the selected image appear.



## 4 To check the parameter details, press INFO.

Press INFO again to return to the previous screen.



## 5 Press OK.

The image selection screen appears.

## 6 Use to select an image for applying the same filter effects, and press OK.

You can only select an image that has not been processed with a filter.



## 7 Select [Save as] and press OK.

### 📝 Memo

- If [Searching for the original image] is selected in Step 3, the original image prior to digital filter application can be retrieved.







## Creating a Composite Image (Index)

Joins a number of images together and creates a new image with them.

### 1 Select in the playback mode palette.

The Index setting screen appears.

### 2 Select [Layout].

Select from  (Thumbnail),  (Square),  (Random1),  (Random2),  (Random3) or  (Bubble).

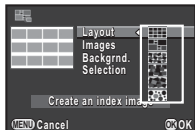





### 3 Select the number of images from 12, 24 or 36 in [Images].

When the number of saved images is smaller than the number selected, empty spaces will appear when [Layout] is set to  and some images may be duplicated for the other layouts.

### 4 Select the background color from white, black, wood grain, cork, or water in [Backgrnd.].

### 5 Select a type of image selection in [Selection].

<input type="checkbox"/> <b>Auto</b>	Picks images automatically from all of the images saved.
<input type="checkbox"/>  <b>Select image(s)</b>	Lets you select images that you want to include in the index image. If <input type="checkbox"/>  is selected, [Select image(s)] appears and leads you to the image selection screen.

<input checked="" type="checkbox"/>  <b>Select a folder</b>	Picks images automatically from the folder selected. If <input checked="" type="checkbox"/>  is selected, [Select a folder] appears and leads you to the folder selection screen.
--	--

### 6 Select [Create an index image] and press **OK**. The index image appears.

### 7 Select [Save] or [Reshuffle] and press **OK**. When [Reshuffle] is selected, you can reselect the images to be included in the index and display a new index image.

#### Memo

- The file name format for index image is "INDXxxxx.JPG".

## Editing Movies

**1** Display the movie to edit in single image display.





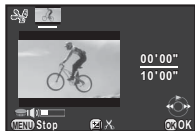

**2** Select  in the playback mode palette.  
The movie editing screen appears.

**3** Select the point where you want to divide the movie.

The frame at the dividing point is displayed at the top of the screen. Up to four points can be selected to divide the original movie into five segments.



## Available operations

	Plays back/pauses a movie.
	Forwards a frame (when paused).
Press and hold 	Fast-forwards playback.
	Reverses a frame (when paused).
Press and hold 	Fast-reverses playback.
	Confirms/cancels a dividing point.
	Adjusts the volume.

Proceed to Step 7 if you do not want to delete any segment.

**4** Press .

The screen to select segments to delete is displayed.

**5** Use  to move the selection frame and press .

The segments to delete are specified.  
(Multiple segments can be deleted at once.)

Press  again to cancel the selection.



**6** Press .

The screen of Step 3 reappears.

**7** Press .

The save confirmation screen appears.

**8** Select [Save as] and press .

## Memo

- Select dividing points in chronological order from the beginning of the movie. When canceling the selected dividing points, cancel each of them in reverse order (from the end of the movie to the beginning). In an order other than specified, you can neither select dividing points nor cancel the selections of the dividing points.



## RAW Development

You can develop RAW images into JPEG images, and save them as a new file.

### 1 Select **RAW** in the playback mode palette.

The screen for selecting a RAW image processing option appears.

### 2 Select the desired option and press **OK**.

<b>Develop a single image</b>	Develops an image.
<b>Develop multiple images</b>	Develops up to 500 images with the same settings.
<b>Develop images in folder</b>	Develops up to 500 images in the selected folder with the same settings.

When [Develop a single image] is selected, proceed to Step 5. The image/folder selection screen appears.

### 3 Press **OK** to select images or folders.

When [Develop multiple images] is selected, up to 500 images can be selected. Press **OK** to finish selecting images.

The screen for selecting the parameter setting method appears.

### 4 Select the parameter setting method and press **OK**.



<b>Develop images as shot</b>	Allows you to change Image Capture Settings only.
<b>Develop images with modified settings</b>	Allows you to change Image Capture Settings, White Balance, Custom Image, Digital Filter, Sensitivity, High-ISO NR, Shadow Correction, and Distortion Correction.

### 5 Use **▲▼** to select the parameter to change, and use **◀▶** to change the value.

For Image Capture Settings, press **▶** and use **▲▼** to select an item.

For White Balance, Custom Image and Digital Filter, press **▶** to display the setting screen.



### 6 Press **OK**.

The save confirmation screen appears.

### 7 Select **[Save as]** and press **OK**.

When [Develop a single image] is selected, select [Continue] or [Exit] and press **OK**.

#### **Caution**

- Only RAW images captured with this camera can be developed.



#### **Memo**

- When [Develop multiple images] or [Develop images in folder] is selected in Step 2, a "xxxR\_JPG" folder with a new number is created, and the JPEG images are stored in it.
- With the provided software "Digital Camera Utility 5", you can develop RAW files on a computer.

# Camera Settings

## Setting the / Functions





The functions assigned to  and  can be changed with [Green Button] of the 3 menu.

## Setting the Operation

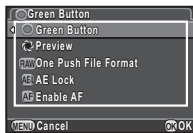
One of the following functions can be assigned to .





Setting	Function
<b>Green Button</b>	Resets the values being adjusted.
<b>Preview</b>	Enables you to check the depth of field by stopping down the aperture of the lens to the actually set value while  is pressed.
<b>One Push File Format</b>	Temporarily changes the file format regardless of the [File Format] setting. You can set whether to apply the setting to only one image or not, and select the file format when  is pressed.
<b>AE Lock</b>	Locks the exposure setting.
<b>Enable AF</b>	Autofocus is performed only when  is pressed and not when the shutter release button is pressed halfway.

## Setting the One Push File Format

**1** Select [One Push File Format] in [Green Button] of 3 menu.

**2** Select  or  for [Cancel after 1 shot].

<input checked="" type="checkbox"/>	The recording format returns to the original file format after a picture is taken.
<input type="checkbox"/>	Settings are retained until any of the following operations is performed: <ul style="list-style-type: none"><li>• When  is pressed again</li><li>• When , <b>MENU</b>, <b>INFO</b> or power switch is pressed</li><li>• When the mode dial is turned</li></ul>

**3** For each file format, select the file format for when  is pressed.

The left side is the [File Format] setting and the right side is the changed file format when  is pressed.

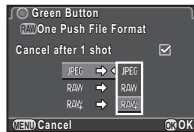

## Setting the Operation in P Mode

Set the value to be changed with  when in **P** mode.

- 1 Select [Green Button] in [Green Button] of  menu.
- 2 Select [E-dial in Program] and change the setting.

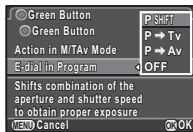

<b>P SHFT</b>	Automatically adjusts the shutter speed and aperture value to obtain a proper exposure (Program Shift).
<b>P → Tv</b>	Adjusts the shutter speed (Shutter Priority Automatic Exposure).
<b>P → Av</b>	Adjusts the aperture value (Aperture Priority Automatic Exposure).
<b>OFF</b>	Disables the  operation when turned in <b>P</b> mode.

### Memo

- If **O** is pressed after turning  in **P** mode, the setting returns to normal **P** mode.

## Setting the Operation in M/TAv Mode

You can set the function of  when in **M** or **TAv** mode.

- 1 Select [Green Button] in [Green Button] of  menu.
- 2 Select [Action in M/TAv Mode] and change the setting.

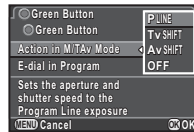

<b>P LINE</b>	Adjusts the aperture value and shutter speed to obtain a proper exposure according to the Program Line.
<b>Tv SHFT</b>	Adjusts the shutter speed while the aperture value remains fixed.
<b>Av SHFT</b>	Adjusts the aperture value while the shutter speed remains fixed.
<b>OFF</b>	Disables the  operation when pressed in <b>M</b> or <b>TAv</b> mode.

## Saving the Settings of a Captured Image

If you take an image that you like, you can save the settings used in that image to make it even easier to replicate the look of the image.

- 1 Display the image to edit in single image display of playback mode.
- 2 Select  in the playback mode palette.  
The screen for changing the settings appears.
- 3 Save the White Balance, Custom Image and Digital Filter settings as necessary.  
Select [— —] to not save a setting.

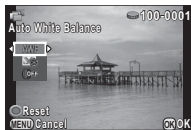

### Available operations

- ▲▼ Changes the function.
- ◀▶ Changes the value.
-  Selects a different image.
- Resets the adjustment value to the default setting.

- 4 Press **OK**.  
The save confirmation screen appears.
- 5 Select a **USER mode number** and press **OK**.  
The selected image along with the settings used in that image are saved in USER1 to 3.



## Using the Saved Settings

You can load and use the saved settings when taking pictures.

- 1 Select [Quick Dial] in  3 menu.
- 2 Select [Smart Effect] in [Quick Dial] screen.
- 3 Save **USER1**, **USER2**, and **USER3** to any of the dial positions 1 to 4.



- 4 In standby mode, set the quick dial to the position 1 to 4.  
The shooting settings saved in the selected position is loaded.

### Memo

- Refer to p.50 for details about the quick dial.

## Displaying the Local Date and Time of the Specified City

1

The date and time set at the time of initial setting (p.26) serve as the date and time of your present location and are reflected in the shooting date and time for images.

Setting the destination to a location other than your present location enables you to display the local date and time on the monitor when traveling abroad and also save images time-stamped with the local date and time.

1 Select [World Time] in 1 menu.

2 Select the time you wish to display in [Time Setting].

Select [Hometown] or [Destination].

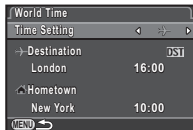

3 Press ▼ to select [→ Destination] and press ►.

The [→ Destination] screen appears.

4 Use ◀▶ to select a city.

Use 🗺️ to change the region.

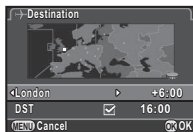

5 Press ▼ to select [DST] (daylight saving time), and use ◀▶ to select  or .

6 Press OK.

The [World Time] screen reappears.

## Memo

- Refer to “List of World Time Cities” (p.84) for cities that can be selected as a hometown or destination.
- Select [🏠 Hometown] in Step 3 to change the city and DST settings for the hometown.
- → appears in the control panel and guide display if [Time Setting] is set to →. Also, the video output setting changes to the video output format for that city.

## Selecting Settings to Save in the Camera

3

Most of the functions set on this camera are saved even if the camera is turned off. For the following function settings, you can select whether to save the settings (☑) or to return the settings to their default values (☐) when the camera is turned off.

Set in [Memory] of the 3 menu.

Function	Default Setting
Flash Mode	<input checked="" type="checkbox"/>
Drive Mode	<input checked="" type="checkbox"/>
White Balance	<input checked="" type="checkbox"/>
Custom Image	<input checked="" type="checkbox"/>
Sensitivity	<input checked="" type="checkbox"/>
EV Compensation	<input checked="" type="checkbox"/>

Function	Default Setting
Flash Exposure Compensation	<input checked="" type="checkbox"/>
Focus Position	<input type="checkbox"/>
Digital Filter	<input type="checkbox"/>
HDR Capture	<input type="checkbox"/>
Playback Info Display	<input checked="" type="checkbox"/>

## Memo

- When [Reset] of the 3 menu is performed, all Memory settings return to the default values.

5

Settings

## File Management Settings

### Protecting Images from Deletion (Protect)

You can protect images from being accidentally deleted.

#### ⚠ Caution

- Even protected images are deleted if the inserted memory card is formatted.

**1** Select **☞** in the playback mode palette.  
The screen for selecting the unit for processing appears.

**2** Select the unit and press **OK**.  
If you selected [All images], proceed to Step 4.

**3** Use **⏏** to select an image.



**4** Select **[Protect]** and press **OK**.  
Repeat Steps 3 and 4 to protect other images.

**5** Press **MENU** to finish setting.

## Selecting the Folder/File Number Settings



### Folder

When images are captured with this camera, a folder is automatically created and the captured images are stored in it. Each folder name consists of a sequential number from 100 to 999 and a string of 5 characters. You can change the folder name in [Folder Name] of the **↖2** menu.

<b>Date</b>	The two digits of the month and day on which the picture was taken are assigned after the folder number. The month and day appear according to the date format set in [Date Adjustment]. Example) 101_0125: for images taken on January 25th
<b>PENTX</b>	The character string "PENTX" is assigned after the folder number. Example) 101PENTX

A folder with a new number is created when the folder name is changed.

#### 📝 Memo

- A maximum of 500 images (100 images for Eye-Fi card) can be stored in a single folder. When the number of captured images exceeds 500, a new folder is created with the number following the number of the folder currently being used. In Exposure Bracketing shooting, images will be stored in the same folder until shooting is completed.
- When [Create New Folder] is selected in the **↖2** menu, a folder is created with the number following the number of the folder currently being used. Only one folder can be created using this feature. Multiple empty folders cannot be created consecutively.

- When [Develop multiple images] or [Develop images in folder] of [RAW Development] is performed, a "xxxR\_JPG" folder with a new number is created, and the JPEG images are stored in it. (p.63)

### ⚠ Caution

- The maximum folder number is 999. After the folder number reaches 999, you cannot capture new images if you attempt to change the folder name or create a new folder, or when the file name number reaches 9999.

### File No.

Each file name consists of a string of 4 characters and a sequential number from 0001 to 9999. You can set whether to continue the sequential numbering for the file name even if a new folder is created in [Sequential Numbering] of [File No.] in the  menu.

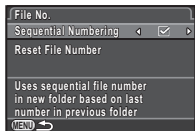

<input checked="" type="checkbox"/>	Continues the sequential numbering for the file name even if a new folder is created.
<input type="checkbox"/>	Returns the file number of the first image saved to a folder to 0001 each time a new folder is created.

Select [Reset File Number] to reset the file number to its default setting.

### 📝 Memo

- When the file number reaches 9999, a new folder is created and the file number is reset.
- One of the following string of characters is used as the file name prefix depending on the [13. Color Space] setting of the **C3** menu.

Color Space	File Name
sRGB	IMGPxxxx.JPG
AdobeRGB	_IMGxxxx.JPG

## Transferring Images via Wireless LAN

You can transfer images to your computer via wireless LAN by using a memory card with a built-in wireless LAN (Eye-Fi card). Select the camera action when using an Eye-Fi card in [Eye-Fi Communication] of [Eye-Fi] in the  menu.

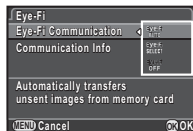

<b>AUTO</b>	Transfers images automatically when there are any images that have not yet been transferred. Only movies with a size of 2 GB or less can be transferred.
<b>SELECT</b>	Transfers images that are selected in playback mode. Only JPEG and RAW images can be transferred.
<b>OFF</b>	Turns off the wireless LAN function.

### ⚠ Caution

- Set up a wireless LAN access point on a computer for the Eye-Fi card connection.
- For RAW images and movie files, the success of transfer depends on the specifications and settings of the Eye-Fi card in use.
- Images may not be transferred when the battery level is low.
- It may take time to transfer a large number of images. The camera may turn off if the internal temperature of the camera becomes high.
- For precautions on the Eye-Fi card, refer to "About Eye-Fi Cards" (p.93).

**Memo**

- [Eye-Fi] of the **2** menu cannot be selected when an Eye-Fi card is not inserted.
- When an Eye-Fi card is used, 100 images can be stored in a single folder. For RAW+ images, two files are counted as one image.
- Select [Communication Info] to check the firmware version of the Eye-Fi card.

**Transferring Selected Images**

You can select the images to transfer.

**1** Set [Eye-Fi Communication] to [SELECT] in [Eye-Fi] of **2** menu.

**2** Select  in the playback mode palette. The screen for selecting a transfer option appears.

**3** Select the desired option and press **OK**.

Select image(s)	Up to 100 images can be selected in one folder.
Select a folder	Transfers all images that can be transferred in the selected folder.

The folder selection screen appears.

**4** Select a folder and press **OK**.

The image selection screen appears.



When [Select a folder] is selected, proceed to Step 7.

**5** Select the image(s) to transfer.

Images that have already been transferred and movies cannot be selected.

**Available operations**

---

	Moves the selection frame.
	Shows the single image display.
	Confirms/cancels the image selection.

---

**6** Press **INFO**.

The confirmation screen appears.

**7** Select [Transfer] and press **OK**.

The single image display reappears after an operation message is displayed.



# Restrictions on Each Capture Mode

#: Restricted x: Not available

Capture Mode		SCN											BC	Bulb			
		AUTO															
Function		AUTO <sup>*1</sup>				AUTO <sup>*1</sup>	x	AUTO <sup>*1</sup>	AUTO <sup>*1</sup>	AUTO <sup>*1</sup>	AUTO <sup>*1</sup>	AUTO <sup>*1</sup>	AUTO <sup>*1</sup>		- ISO 1600		
Sensitivity		AUTO <sup>*1</sup>	AUTO <sup>*1</sup>	AUTO <sup>*1</sup>	AUTO <sup>*1</sup>	AUTO <sup>*1</sup>	x	AUTO <sup>*1</sup>	AUTO <sup>*1</sup>	AUTO <sup>*1</sup>	AUTO <sup>*1</sup>	AUTO <sup>*1</sup>	AUTO <sup>*1</sup>		- ISO 1600		
Flash		<sup>*2</sup>	<sup>*2</sup>	x	<sup>*2</sup>	<sup>*2</sup>	x	<sup>*2</sup>	<sup>*2</sup>	x	<sup>*2</sup>	x	x			x	
Drive Mode	Single Frame Shooting					x			x	x						x	
	Continuous Shooting					<sup>*3</sup>	x		x	<sup>*3</sup>	<sup>*3</sup>			x	x	x	
	Self-timer					x			x	x						x	
	Remote Control	0 sec./ 3 sec.					x			x	x						<sup>*2</sup>
		Continuous Shooting					x	x		x	x	x			x	x	x
	Exposure Bracketing						x	x		x	x	x			x	x	x
	Multi-exposure						x	x		x	x	x			x		x
Interval Shooting						x	# <sup>*4</sup>		x	x	x			x	x		
Focus Method		<sup>*1</sup>	<sup>*1</sup>			<sup>*1</sup>		<sup>*1</sup>		<sup>*1</sup>	<sup>*1</sup>	<sup>*1</sup>	<sup>*1</sup>			<sup>*5</sup>	
File Format	RAW/ RAW+						x		x					x		x	

Capture Mode Function	AUTO	SCN											BC	Bulb			
Shake Reduction							×									×	
White Balance	AWB <sup>*1</sup>	AWB <sup>*1</sup>	AWB <sup>*1</sup>	AWB <sup>*1</sup>	AWB <sup>*1</sup>	AWB <sup>*1</sup>	AWB <sup>*1</sup>	AWB <sup>*1</sup>	AWB <sup>*1</sup>	AWB <sup>*1</sup>	AWB <sup>*1</sup>	AWB <sup>*1</sup>	AWB <sup>*1</sup>				
Custom Image	×	×	×	×	×	×	×	×	×	×	×	×	×				
Digital Filter							×										
HDR Capture							*6		×						×	×	×
Save RAW Data						×	×			×	×						×

\*1 Fixed to; the setting cannot be changed.

\*2 Limited to; available settings are limited.

\*3 Fixed to; for JPEG, for RAW/RAW

\*4 The shortest shooting interval is 10 sec.

\*5 Focus methods other than and can be selected.

\*6 Specific settings are used.

## Restrictions on the Combinations of Special Functions

x: Not available

		Continuous Shooting	Exposure Bracketing	Multi-exposure	Interval Shooting	Digital Filter	Smart Effect	HDR Capture
Flash								x
Drive Mode	Continuous Shooting		x	x	x			x
	Self-timer	x	x	x	x			
	Remote Continuous Shooting	x	x	x	x			x
	Exposure Bracketing	x		x	x			x
	Multi-exposure	x	x		x	x	x	x
	Interval Shooting	x	x	x				
File Format	RAW/RAW+	 *1		x				x
Custom Image							x	
Digital Filter				x			x	x
Smart Effect				x		x		x
Save RAW Data		x	x	x				x

\*1 Fixed to; the setting cannot be changed.

## Functions Available with Various Lenses

<b>A group</b>	01 STANDARD PRIME 02 STANDARD ZOOM 06 TELEPHOTO ZOOM 08 WIDE ZOOM
<b>B group</b>	04 TOY WIDE 05 TOY TELEPHOTO 07 MOUNT SHIELD
<b>C group</b>	03 FISH-EYE
<b>D group</b>	ADAPTER Q FOR K MOUNT LENS

✓ : Available # : Restricted ✕ : Not available

Function \ Lens Type	A group	B group	C group	D group
<b>AF</b>	✓	✕	✕	✕
<b>MF</b>	✓	✓ <sup>*1</sup>	✓	✓
Quick-shift focus	✓	✕	✕	✕
Autofocus Method	✓	✕	✕	✕
MF Autozoom	✓	✕	✕	✕
Aperture control	✓	✕	✕	# <sup>*2</sup>
ND filter on the lens	✓	✕	✕	✕
Shutter on the lens	✓	✕	✕	✓ <sup>*3</sup>
Electronic shutter	✓ <sup>*4</sup>	✓	✓	✓ <sup>*4</sup>
<b>AUTO/SCN/BC mode</b>	✓	# <sup>*5</sup>	# <sup>*5</sup>	# <sup>*2</sup>
<b>P/Tv/Av mode</b>	✓	# <sup>*5</sup>	# <sup>*5</sup>	# <sup>*2</sup>
<b>M mode</b>	✓	# <sup>*5</sup> # <sup>*6</sup>	# <sup>*5</sup> # <sup>*6</sup>	# <sup>*2</sup>
<b>Ⓜ mode</b>	✓	# <sup>*5</sup>	# <sup>*5</sup>	# <sup>*2</sup>
Movie Continuous AF	✓ <sup>*7</sup>	✕	✕	✕
P-TTL auto flash	✓ <sup>*8</sup>	✓ <sup>*9</sup>	# <sup>*9</sup> # <sup>*10</sup>	# <sup>*9</sup> # <sup>*11</sup>

- \*1 No focusing mechanism on 07 MOUNT SHIELD
- \*2 Set the aperture manually.
- \*3 Lens shutter built-in to the adapter used.
- \*4 Set [1. Lens Shutter Options] to [Lens and electronic shutters] or [Electronic shutter only] in the **C1** menu. When [Lens and electronic shutters] is selected, you can take pictures at higher speeds with the electronic shutter than with the lens shutter.  
Ex.) With a 01 STANDARD lens  
Pictures are taken at 1/2000 sec. or slower with the lens shutter and 1/2000 sec. or faster with the electronic shutter.
- \*5 Aperture value fixed.
- \*6 **Bulb** mode is not available. Allows the use of a slow shutter speed of up to 2 sec.
- \*7 06 TELEPHOTO ZOOM lens is not available.
- \*8 Built-in flash: 1/2000 sec., external flash: 1/250 sec.
- \*9 Flash sync speed is approx. 1/13 sec.
- \*10 Light is unevenly distributed.
- \*11 Light may be unevenly distributed.

### Compatibility with the Built-in Flash

Depending on the lens being used, the use of the built-in flash may be limited.

Lens	Restrictions when using the built-in flash
<b>02 STANDARD ZOOM</b>	If the focal length is less than 6 mm, vignetting may occur at the wide-angle setting.
<b>03 FISH-EYE</b>	The built-in flash is not available due to vignetting.
<b>08 WIDE ZOOM</b>	Light may be unevenly distributed depending on the shooting conditions because the built-in flash does not cover the angle of view of the lens.

## About Hoods

When using a hood with a 02 STANDARD ZOOM lens, be sure to use the PH-RBB 40.5mm. If the PH-SBA 40.5mm is used, vignetting may occur at the wide-angle setting.

## About Filters

Vignetting will occur at the wide-angle setting if the 100 PL FILTER is used with a 02 STANDARD ZOOM lens.

## Using a K-Mount Lens

A K-mount lens can be attached to this camera with the use of the optional Adapter Q for K Mount Lens. When a K-mount lens is used, the focal length must be set manually for some functions such as Shake Reduction, since the focal length cannot be obtained automatically.

- 1 Turn the camera off.
- 2 Attach the adapter and lens to the camera, and turn the camera on.  
The [Input Focal Length] screen appears.
- 3 Set the lens focal length.



## Available operations

- |    |                                  |
|----|----------------------------------|
| ▲▼ | Changes the value of each digit. |
| ◀▶ | Selects a digit.                 |
| ⊖  | Selects a value from the list.   |

When using a zoom lens, select the actual focal length which the zoom is set to.

## 4 Press **OK**.

The camera returns to standby mode.

## Memo

- The focal length setting can be changed in [Input Focal Length] of the **☑2** menu.
- When the Adapter Q for K Mount Lens is used, the camera operates in **Av** mode when the capture mode is set to other than **M** mode.
- Refer to the Adapter Q for K mount lens manual for details.

## Functions when Using an External Flash

Using an optional external flash AF540FGZ, AF540FGZ II, AF360FGZ, AF360FGZ II, AF200FG or AF160FC enables a variety of flash modes, such as P-TTL auto flash mode.

✓: Available X: Not available

Camera Function \ Flash	Built-in flash	AF540FGZ AF540FGZ II AF360FGZ AF360FGZ II	AF200FG AF160FC
Red-eye reduction flash	✓	✓	✓
Auto Flash Discharge	✓	✓	✓
Automatic switch to the flash sync speed	✓	✓	✓
Automatic setting of the aperture value in <b>P</b> or <b>Tv</b> mode	✓	✓	✓
P-TTL auto flash	✓	✓	✓
Slow-speed Sync flash	✓	✓	✓
Flash Exposure Compensation	✓	✓	✓
Auto zoom flash head	X	✓	X
AF assist light of external flash	X	X	X
Trailing Curtain Sync flash	✓	✓	X
Contrast-control-sync flash	X	X	X
Slave flash	X	X	X
Wireless flash	X	X	X

### ⚠ Caution

- The built-in flash does not discharge if the camera is connected to an external flash.
- Combining with flashes from other manufacturers may cause equipment breakdown.

### 📌 Memo

- When an external flash is attached directly to the hot shoe of the camera, the camera's center of gravity is shifted, making it difficult to take pictures. Attach the Hot Shoe Adapter F<sub>o</sub> (optional) to the camera hot shoe and the Off-Camera Shoe Adapter F (optional) to the bottom of the external flash, and connect these with the Extension Cord F5P (optional) as shown in the illustration. The Off-Camera Shoe Adapter F can be mounted to your tripod using the tripod screw.

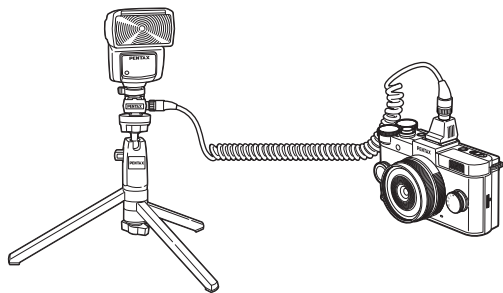

- To use an AF160FC flash with the camera, a commercially available step-up ring or similar accessory is needed.

### Flash sync speed when using the flash

Lens Type (p.74)	Flash Sync Speed	
<b>A group</b>	1/2000 sec. or slower	When [1. Lens Shutter Options] is set to [Electronic shutter only] in the <b>C1</b> menu: 1/13 sec. or slower
	When using an external flash: 1/250 sec. or slower	
<b>B group</b> <b>C group</b>	1/13 sec. or slower	



# Troubleshooting

## Memo

- In rare cases, the camera may not operate correctly due to static electricity. This can be remedied by taking the battery out and putting it back in again. If the camera operates correctly, it does not require any repairs.

Problem	Cause	Remedy
The camera does not turn on.	Battery is not installed properly.	Check the orientation of battery.
	The battery power is low.	Charge the battery.
The shutter cannot be released.	The built-in flash is charging.	Wait until charging is finished.
	There is no available space on the memory card.	Insert a memory card with available space or delete unwanted images.
	Data is being processed.	Wait until processing is finished.
Autofocus does not work.	The subject is difficult to focus on.	<b>AF</b> cannot work well for low-contrast objects (the sky, white walls, etc.), dark colors, intricate designs, rapidly-moving objects or scenery shot through a window or a net-like pattern. Lock focus on another object located at the same distance as your subject, then aim at the target and take a picture. Alternatively, use <b>MF</b> . (p.39)
	The subject is too close.	Move away from the subject and take a picture.

Problem	Cause	Remedy
The focus cannot be locked.	[Autofocus Method] is set to  or .	Set [Autofocus Method] to  or . (p.38)
	The capture mode is set to , ,  or  of <b>SCN</b> mode.	[Autofocus Method] is fixed to  in these modes. Set a capture mode other than those shown to the left.
The built-in flash does not discharge.	When the flash mode is set to  or , the flash does not discharge if the subject is bright.	Change the flash mode. (p.36)
	The capture mode is set to , , , , , , ,  or  of <b>SCN</b> mode.	The flash mode is fixed to  in these modes. Set a capture mode other than those shown to the left.
The camera is not recognized when it is connected to a computer.	The USB connection mode is set to [PTP].	Set [USB Connection] to [MSC] in [Interface Options] of the  menu.
The shooting settings cannot be changed.	The quick dial is set to the position 1 to 4.	When you use the quick dial to take pictures, priority is given to the settings saved in the quick dial.

Problem	Cause	Remedy
Dust or dirt particles appear in images.	The CMOS sensor is dirty or dusty.	Activate [Dust Removal] from the  4 menu. The Dust Removal function can be activated every time the camera is turned on and off. Use a brush-less blower to remove dirt and dust from the CMOS sensor. Using a blower with a brush may scratch the CMOS sensor. Do not wipe the CMOS sensor with a cloth.
There are visible defects in a captured image, or parts in the display monitor that do not light up or remain lit.	There are defective pixels in the CMOS sensor.	Attach a lens cap to a lens that has a lens shutter, such as the 01 STANDARD PRIME, and perform [Pixel Mapping] of the  4 menu. It takes about 30 seconds to correct the defective pixels, so be sure to install a fully charged battery.

## Error Messages

Error Messages	Description
Memory card full	The memory card is full and no more images can be saved. Insert a new memory card or delete unwanted files.
No image	There are no images that can be played back on the memory card.
This image cannot be displayed	You are trying to play back an image in a format not supported by this camera. You may be able to play it back on a computer.
No card in the camera	There is no memory card inserted in the camera.
Memory card error	The memory card has a problem, and image capture and playback are impossible. You may be able to play it back on a computer.
	Failed to initialize Eye-Fi function when using the Eye-Fi card. Press  .
Card is not formatted	The memory card you have inserted is unformatted or has been used on another device and is not compatible with this camera. Use the card after formatting it with this camera.
Card is locked	The write-protect switch on the memory card you have inserted is locked. (p.93)
This image cannot be magnified	You are trying to magnify an image that cannot be magnified.
This image is protected	You are trying to delete an image that is protected. Remove protection from the image. (p.68)



Error Messages	Description
Not enough battery power remaining to activate Pixel Mapping	Appears during Pixel Mapping or when trying to update the firmware if the battery level is insufficient. Install a fully charged battery.
Not enough battery power remaining to update the firmware	
Unable to update firmware. There is a problem with the firmware update file	Unable to update the firmware. The update file is damaged. Try downloading the update file again.
Image folder cannot be created	The maximum folder number (999) and file number (9999) are being used, and no more images can be saved. Insert a new memory card or format the card.
Unable to store image	The image could not be saved because of a memory card error.
The operation could not be completed correctly	The camera was unable to adjust the manual white balance. Try the operation again.
No more images can be selected	You cannot select more than the maximum number of images for Index, Select & Delete, RAW Development, and Select image(s) for Eye-Fi.
No image can be processed	There are no images that can be processed using Digital Filter or RAW Development function.
This image cannot be processed	Appears when you try to perform Resize, Cropping, Red-eye Edit, Digital Filter, Movie Edit, RAW Development, Save as Manual WB, or Save Smart Effect for images captured with other cameras, or when you try to perform Resize or Cropping for minimum file size images.
The camera failed to create an image	The creation of an index print image failed.

Error Messages	Description
This function is not available in the current mode	You are trying to set a function that is not available for the capture mode that is set. (p.71)
The camera will turn off to prevent damage from overheating	The camera will turn off because its internal temperature is too high. Leave the camera turned off until it has had time to cool down before turning on the camera again.
Set the Eye-Fi communication to "SELECT"	Images cannot be transferred when [Eye-Fi Communication] is not set to [SELECT] in [Eye-Fi] of the  menu. (p.69)
Image not found	There are no images that can be transferred when an Eye-Fi card is used.
Cannot be selected	This folder cannot be selected because the number of files stored in this folder exceeds the maximum number allowed. (p.70)

# Main Specifications

## Model Description

Type	Lens-interchangeable SL digital camera
Lens Mount	PENTAX bayonet Q-mount
Compatible Lens	Q-mount lenses

## Image Capture Unit

Image Sensor	Type: CMOS sensor with a primary color filter Size: 1/1.7-inch
Effective Pixels	Approx. 12.4 megapixels
Total Pixels	Approx. 12.76 megapixels
Dust Removal	Image sensor cleaning using ultrasonic vibrations "DR II"
Sensitivity (Standard output)	AUTO: ISO 100 to ISO 12800 (1/3 EV steps) • Up to ISO 1600 when the shutter speed is set to 2 sec. or slower.
Image Stabilizer	Sensor shift Shake Reduction

## File Formats

Recording Formats	RAW (DNG), JPEG (Exif 2.3), DCF 2.0 compliant
Recorded Pixels	JPEG: <b>4:3</b> <b>L</b> 12M (4000×3000) <b>M</b> 7M (3072×2304) <b>S</b> 3M (1920×1440) <b>3:2</b> <b>L</b> 10M (4000×2664) <b>M</b> 6M (3072×2048) <b>S</b> 2M (1920×1280) <b>16:9</b> <b>L</b> 9M (4000×2248) <b>M</b> 5M (3072×1728) <b>S</b> 2M (1920×1080) <b>1:1</b> <b>L</b> 9M (2992×2992) <b>M</b> 5M (2304×2304) <b>S</b> 2M (1440×1440) RAW: <b>4:3</b> <b>L</b> 12M (4000×3000)

Quality Level	RAW (12 bit): DNG JPEG: <b>★★★</b> (Best), <b>★★</b> (Better), <b>★</b> (Good) • RAW and JPEG simultaneously recordable
Color Space	sRGB, AdobeRGB
Storage Media	SD Memory Cards, SDHC Memory Cards, SDXC Memory Cards and Eye-Fi Cards
Storage Folder	Date (100_1018, 100_1019...)/ PENTX (100PENTX, 101PENTX...)

## LCD Monitor

Type	TFT color LCD monitor, wide angle viewing, with AR coating
Size	3.0 inches
Dots	Approx. 460,000 dots
Adjustment	Brightness and colors adjustable
Display	Field of view: approx. 100%, Electronic Level, Grid Display (4 × 4 Grid, Golden Section, Scale), Highlight Alert, Histogram

## White Balance

Auto	TTL by CMOS image sensor
Preset	Daylight, Shade, Cloudy, Fluorescent Light ( <b>D</b> : Daylight Color, <b>N</b> : Daylight White, <b>W</b> : Cool White, <b>L</b> : Warm White), Tungsten, Flash, <b>CTE</b> , Manual
Manual	Configuration using the display screen (up to 3 settings can be saved), Copying the white balance settings of a captured image
Fine Adjustment	Adjustable ±7 steps on A-B axis and G-M axis

## Autofocus System



Type	Contrast detection AF
Brightness Range	EV 0 to 18 (ISO100)
Focus Method	<b>AF/MF</b> switching
Autofocus Method	Face Detection, Tracking, Multiple AF Points, Select, Spot
AF Assist Light	Dedicated LED AF assist light

MF Autozoom	Off/×2/×4/×6
Focus Peaking	Off/On

### Exposure Control

Type	TTL image sensor metering Metering modes: Multi-segment metering, Center-weighted metering, and Spot metering
Metering Range	EV 1 to 17 (ISO 100, F1.9 lens), +2 EV with Electronic Shutter enabled, +2 EV with an ND filter
Exposure Modes	Auto Picture modes: Standard, Portrait, Landscape, Macro, Night Scene Portrait, Sunset, Blue Sky, Forest Scene modes: Portrait, Landscape, Macro, Moving Object, Night Scene Portrait, Sunset, Blue Sky, Forest, Night Scene, Night Scene HDR*, Night Snap, HDR*, Quick Macro*, Food, Pet, Kids, Surf & Snow, Backlight Silhouette, Candlelight, Stage Lighting, Museum Program, Shutter Priority, Aperture Priority, Manual, Bulb, Blur Control* *JPEG only
EV Compensation	± 3 EV (1/3 EV steps)
AE Lock	Can be assigned to the  button from the menu.
Shutter	Lens shutter: 1/2000 - 30 seconds (1/3 EV steps, 1/8000 - 30 seconds with Electronic Shutter enabled), Bulb • When using a lens that has no lens shutter, shooting at 1/8000 - 2 seconds with the electronic shutter is available, while Bulb shooting is not available.
Aperture	From wide open to F8 • Aperture is fixed when using a lens that has no lens shutter.
ND Filter	Off/On • Not available when using a lens that has no lens shutter.

### Drive Modes

Mode Selection	Single frame, Continuous (Hi, Lo), Self-timer (12s, 2s), Remote Control (0 sec., 3 sec., continuous), Exposure Bracketing (3 frames, remote control), Multi-exposure (0 sec., self-timer, remote control), Interval Shooting
Continuous FPS	Approx. 5 fps, JPEG (4:3  12M/★★★/Continuous Hi): up to 5 frames Approx. 1.5 fps, JPEG (4:3  12M/★★★/Continuous Lo): up to 100 frames

### Built-in Flash



Type	Built-in retractable P-TTL flash Guide number: approx. 4.9 (ISO100/m), approx. 7 (ISO200/m) Angle of view coverage: equivalent to 28 mm in 35 mm format
Flash Modes	P-TTL, Red-eye Reduction, Slow-speed Sync, Trailing Curtain Sync
Sync Speed	Lens shutter: built-in flash 1/2000 seconds Used with external flash units: 1/250 seconds Electronic shutter: 1/13 seconds
Flash Exposure Compensation	-2.0 to +1.0 EV

### Capture Functions

Custom Image	Bright, Natural, Portrait, Landscape, Vibrant, Radiant, Muted, Bleach Bypass, Reversal Film, Monochrome, Cross Processing
Noise Reduction	High-ISO NR
Dynamic Range Setting	Highlight Correction, Shadow Correction
Lens Correction	Distortion Correction
Digital Filter	Toy Camera, High Contrast, Shading, Tone Expansion, Invert Color, Extract Color, Unicolor Bold, Water Color, Posterization, Slim, Fish-eye
HDR Capture	Auto, Type1, Type2

Multi-exposure	Number of Shots: 2-9 Exposure adjusted automatically.
Interval Shooting	Shooting interval: 3 sec. to 24 hr. Start Interval: immediately, from the set time Number of Shots: up to 999 images
Smart Effect	Brilliant Color, Unicolor Bold, Vintage Color, Antique, Warm Fade, Tone Expansion, Bold Monochrome, Faded Color, Vibrant Color Enhance, USER 1-3
Electronic Level	Displayed on LCD monitor (horizontal and vertical directions)



### Movie

Recording Format	MPEG-4 AVC/H.264
Recorded Pixels	 (1920×1080, 16:9, 30 fps/25 fps/24 fps)  (1280×720, 16:9, 30 fps/25 fps/24 fps)  (640×480, 4:3, 30 fps/25 fps/24 fps)
Sound	Built-in monaural microphone
Recording Time	Up to 25 minutes; automatically stops recording if the internal temperature of the camera becomes high.
Custom Image	Bright, Natural, Portrait, Landscape, Vibrant, Radiant, Muted, Bleach Bypass, Reversal Film, Monochrome, Cross Processing
Digital Filter	Toy Camera, High Contrast, Shading, Tone Expansion, Invert Color, Extract Color, Unicolor Bold, Water Color, Posterization, Slim, Fish-eye
Interval Movie Record	Recording interval: 3 sec., 5 sec., 10 sec., 30 sec., 1 min., 5 min., 10 min., 30 min., 1 hr. Recording time: 12 sec. to 99 hr. Start Interval: immediately, from the set time
Movie Continuous AF	Off/On

### Playback Functions

Playback View	Single frame, Multi-image display (4, 9, 30, and 56 thumbnails), Image magnification (up to 16×, scrollable, quick zoom), Rotated image display, Histogram (Y histogram, RGB histogram), Highlight Alert, Auto Image Rotation, Detailed Information Display, Folder Display, Calendar Filmstrip Display, Slideshow
Delete	Single image, all images, select & delete, folder, instant review image
Digital Filter	Base Parameter Adj, Toy Camera, High Contrast, Shading, Tone Expansion, Invert Color, Extract Color, Unicolor Bold, Water Color, Posterization, Slim, Fish-eye, Retro, Sketch, Miniature, Soft, Starburst
RAW Development	File Format (JPEG), Aspect Ratio, Color Space, White Balance, Custom Image, Digital Filter, Sensitivity, High-ISO NR, Shadow Correction, Distortion Correction
Editing Features	Resize, Cropping (aspect ratio can be changed), Index, Movie Edit (dividing a movie file and deleting unwanted segments), Capturing a JPEG still picture from a movie, Red-eye Edit, Save RAW Data

### Customization

Custom Functions	16 items
Mode Memory	11 items
Button/Dial Customization	  button: Green Button, Preview, One Push File Format, AE Lock, Enable AF Quick Dial: Smart Effect, Aspect Ratio, Focus Method, Focus Peaking, ND Filter
World Time	World Time settings for 75 cities (28 time zones)

### Power Supply

Battery Type	Rechargeable Lithium-ion Battery D-L168
AC Adapter	AC Adapter Kit K-AC115 (optional)

Battery Life	<p>Number of recordable images (with 50% flash usage): approx. 250 images, (without flash usage): approx. 260 images          Playback time: approx. 160 minutes</p> <ul style="list-style-type: none"> <li>Tested in compliance with CIPA standard using a new rechargeable lithium-ion battery at a temperature of 23°C. Actual results may vary depending on the shooting conditions/ circumstances.</li> </ul>
--------------	--

#### Interfaces

Connection Port	USB 2.0/AV output terminal, HDMI output terminal (Type D)
USB Connection	MSC/PTP
Video Output Format	NTSC/PAL

#### Dimensions and Weight

Dimensions	Approx. 105.0 mm (W) × 58.0 mm (H) × 34.0 mm (D) (excluding the operation parts and protrusion)
Weight	Approx. 203 g (loaded and ready with the dedicated battery and SD Memory Card) Approx. 183 g (body only)

#### Accessories

Package Contents	<p>USB Cable I-USB7, Strap O-ST131, Rechargeable Lithium-ion Battery D-LI68, Battery Charger D-BC68P, AC plug cord, Software (CD-ROM) S-SW151, Start Guide</p> <p>&lt;Mounted on the camera&gt;          Hot shoe cover Fk, Body mount cover</p>
Software	Digital Camera Utility 5

### Approximate Image Storage Capacity and Playback Time

(When using the fully charged battery)

Battery	Temperature	Normal Shooting	Flash Photography		Playback Time
			50% Use	100% Use	
D-LI68	23°C	260	250	240	160 minutes

- The image storage capacity (normal recording and flash use 50%) is based on measuring conditions in accordance with CIPA standards, while other data is based on our measuring conditions. Some deviation from the above figures may occur in actual use depending on the selected capture mode and shooting conditions.

### Approximate Image Storage Capacity by Size

(When using a 2 GB memory card)

Aspect Ratio	Recorded Pixels	JPEG Quality			RAW
		★★★	★★	★	
16:9	<b>L</b> 9M	544	755	1264	103
	<b>M</b> 5M	908	1250	2060	–
	<b>S</b> 2M	2183	2939	4596	–
3:2	<b>L</b> 10M	461	641	1077	103
	<b>M</b> 6M	771	1064	1764	–
	<b>S</b> 2M	1871	2533	4010	–
4:3	<b>L</b> 12M	410	571	961	103
	<b>M</b> 7M	687	951	1582	–
	<b>S</b> 3M	1679	2281	3639	–
1:1	<b>L</b> 9M	547	759	1270	103
	<b>M</b> 5M	908	1250	2060	–
	<b>S</b> 2M	2183	2939	4596	–

- The number of storable images may vary depending on the subject, shooting conditions, selected capture mode and memory card, etc.

## List of World Time Cities

Region	City	Video Output Format
North America	Honolulu	NTSC
	Anchorage	NTSC
	Vancouver	NTSC
	San Francisco	NTSC
	Los Angeles	NTSC
	Calgary	NTSC
	Denver	NTSC
	Chicago	NTSC
	Miami	NTSC
	Toronto	NTSC
	New York	NTSC
	Halifax	NTSC
	Central and South America	Mexico City
Lima		NTSC
Santiago		NTSC
Caracas		NTSC
Buenos Aires		PAL
Sao Paulo		PAL
Rio de Janeiro		NTSC
Europe	Lisbon	PAL
	Madrid	PAL
	London	PAL
	Paris	PAL
	Amsterdam	PAL
	Milan	PAL

Region	City	Video Output Format	
Europe	Rome	PAL	
	Copenhagen	PAL	
	Berlin	PAL	
	Prague	PAL	
	Stockholm	PAL	
	Budapest	PAL	
	Warsaw	PAL	
	Athens	PAL	
	Helsinki	PAL	
	Moscow	PAL	
	Africa/West Asia	Dakar	PAL
		Algiers	PAL
Johannesburg		PAL	
Istanbul		PAL	
Cairo		PAL	
Jerusalem		PAL	
Nairobi		PAL	
Jeddah		PAL	
Tehran		PAL	
Dubai		PAL	
Karachi		PAL	
Kabul		PAL	
Male		PAL	
Delhi	PAL		
Colombo	PAL		

Region	City	Video Output Format
Africa/West Asia	Kathmandu	PAL
	Dacca	PAL
East Asia	Yangon	NTSC
	Bangkok	PAL
	Kuala Lumpur	PAL
	Vientiane	PAL
	Singapore	PAL
	Phnom Penh	PAL
	Ho chi Minh	PAL
	Jakarta	PAL
	Hong Kong	PAL
	Beijing	PAL
	Shanghai	PAL
	Manila	NTSC
	Taipei	NTSC
Oceania	Seoul	NTSC
	Tokyo	NTSC
	Guam	NTSC
	Perth	PAL
	Adelaide	PAL
	Sydney	PAL
	Noumea	PAL
	Wellington	PAL
	Auckland	PAL
	Pago Pago	NTSC

## Operating Environment for USB Connection and Provided Software

With the provided software “Digital Camera Utility 5”, you can develop RAW files on a computer. Install the software from the provided CD-ROM (S-SW151).

We recommend the following system requirements to connect the camera to a computer and to use the software.

### Windows

<b>OS</b>	Windows 8.1 (32-bit, 64-bit), Windows 8 (32-bit, 64-bit), Windows 7 (32-bit, 64-bit) or Windows Vista (32-bit, 64-bit)
<b>CPU</b>	Intel Core 2 Duo or higher
<b>RAM</b>	2 GB or more
<b>HDD</b>	For installing and starting up the program: 100 MB or more of available space For saving image files: Approx. 5 MB/file (JPEG), Approx. 25 MB/file (RAW)
<b>Monitor</b>	1280×1024 dots, 24-bit full color or higher

### Macintosh



























<b>OS</b>	OS X 10.9, 10.8 or 10.7, or Mac OS X 10.6
<b>CPU</b>	Intel Core 2 Duo or higher
<b>RAM</b>	2 GB or more
<b>HDD</b>	For installing and starting up the program: 100 MB or more of available space For saving image files: Approx. 5 MB/file (JPEG), Approx. 25 MB/file (RAW)
<b>Monitor</b>	1280×1024 dots, 24-bit full color or higher

### Memo

- QuickTime is required to play back movies transferred to a computer with an OS other than Windows 8 and Windows 8.1.

You can download it from the following site:  
<http://www.apple.com/quicktime/download/>

## Symbols

 menu.....	15
 menu.....	17
 menu.....	17
 menu.....	18
 menu.....	19
 Portrait.....	30
 Landscape.....	30
 Macro.....	30
 Moving Object.....	30
 Night Scene Portrait ..	30
 Sunset.....	30
 Blue Sky.....	30
 Forest.....	30
 Night Scene.....	30
 Night Scene HDR.....	30
 Night Snap.....	30
 HDR.....	31
 Quick Macro.....	31
 Food.....	31
 Pet.....	31
 Kids.....	31
 Surf & Snow.....	31
 Backlight Silhouette...	31
 Candlelight.....	31
 Stage Lighting.....	31
 Museum.....	31
 mode.....	34

## A

AC adapter.....	24
-----------------	----

Action in M/TAv Mode.....	65
AE Lock.....	64
AE Metering.....	35
AE-L with AF Locked.....	19
<b>AF</b> .....	37
AF area.....	38
AF Assist Light.....	37
AF assist light.....	7
AF frame.....	28
AF Release Options.....	38
AF with Remote Control ..	42
AF/MF Settings.....	15
Antique (Smart Effect).....	50
Aperture Priority Automatic Exposure.....	32
Aspect Ratio.....	45
Auto Image Rotation.....	55
<b>AUTO</b> mode.....	28, 30
Auto Picture modes... ..	28, 30
Auto Power Off.....	26
Auto SR Off.....	40
Autofocus.....	38
Autofocus Method.....	38
AV device.....	56
<b>Av</b> mode.....	32
AWB in Tungsten Light....	20

## B

Backlight Silhouette  ...	31
Base Parameter Adj (Digital Filter).....	59

Battery.....	22
Battery cover.....	7
<b>BC</b> mode.....	31
Bleach Bypass (Custom Image).....	48
Blue Sky  .....	30
Blur Control mode.....	31
Bold Monochrome (Smart Effect).....	50
Bracketing Order.....	42
Bright (Custom Image)....	48
Brightness adjustment.....	47
Brightness histogram.....	12
Brilliant Color (Smart Effect).....	50
Built-in flash.....	36
<b>Bulb</b> .....	33
Bulb Shooting.....	33
Button.....	8

## C

Calendar Filmstrip Display.....	54
Candlelight  .....	31
Capture mode.....	30
Card access lamp.....	7
Card cover.....	7
Center-weighted metering.....	35
Charging the battery.....	22
City names.....	26, 84

CMOS sensor.....	7
Color Space.....	20, 69
Computer.....	57
Connection cable cover.....	7, 24
Continuous playback.....	55
Continuous Shooting.....	41
Control panel.....	10, 13
Create New Folder.....	68
Cropping.....	58
Cross Processing.....	49
Cross Processing (Custom Image).....	48
Custom Image.....	48
Custom Setting menus....	19

## D

Date Adjustment.....	27
DC coupler.....	24
Delete.....	29
Delete All Images.....	17
Depth of field.....	33
Destination.....	67
Detailed Information Display.....	12
Developing RAW images.....	63
Dial.....	8
Dial indicator.....	28
Digital Camera Utility 5.....	63, 85





Digital Filter .....	49, 59
Direct keys .....	13
Display Color .....	18
Display style selection .....	53
Displaying multiple images .....	53
Distortion Correction .....	15
D-Range Settings .....	47
Drive Mode .....	40
DST (daylight saving time) .....	26, 67
Dust Removal .....	78
Dynamic range .....	47

## E

E-dial in Program .....	65
Electronic Level .....	10, 16
Electronic shutter .....	74
Enable AF .....	64
Error messages .....	78
EV bar scale .....	32
EV Compensation .....	32
Exposure .....	35
Exposure Bracketing .....	42
Exposure Modes .....	32
Exposure Setting .....	17, 34
External flash .....	76
Extract Color (Digital Filter) .....	49, 59
Eye-Fi card .....	25, 69

## F

Face Detection (Autofocus Method) .....	38
---	----

Faded Color (Smart Effect) .....	50
File Format .....	45
File No. ....	69
Filter .....	49, 59
Firmware .....	19
Firmware Info/Options .....	19
Fish-eye (Digital Filter) .....	49, 59
Flash .....	36, 76
Flash compensation .....	36
Flash pop-up switch .....	36
Flash When Retracted .....	36
Flicker Reduction .....	18
Focus Method .....	37
Focus Peaking .....	39
Focus ring .....	39
Focus Ring in AF Mode .....	37
Focusing .....	37
Focus-priority .....	20
Folder Display .....	54
Folder Name .....	68
Food  .....	31
Forest  .....	30
Format .....	27
Framerate .....	45
Function Restrictions .....	71

## G

Green Button .....	64
● (Green button) operation .....	64
Grid Display .....	16
Guide Display .....	28
Guide number .....	37

## H

HDMI output format .....	56
HDMI terminal .....	56
HDR  .....	31
HDR Capture .....	47
High Contrast (Digital Filter) .....	49, 59
High-ISO NR .....	35
Highlight Alert .....	16, 17
Highlight Correction .....	47
Histogram Display .....	12, 16
Hometown .....	26, 67
Hot shoe .....	7

## I

Image Capture Settings .....	45
Image finishing tone .....	48
Image storage capacity .....	83
Index .....	61
Initial settings .....	26
Initializing a memory card .....	27
Input Focal Length .....	75
Instant Review .....	16, 28
Interface Options .....	18, 56
Interval Movie Record .....	44
Interval Shooting .....	43
Invert Color (Digital Filter) .....	49, 59
ISO sensitivity .....	35

## J

JPEG .....	45
------------	----

## K











Kids  .....	31
K-mount lens .....	75



## L

Landscape (Custom Image) .....	48
Landscape  .....	30
Language setting .....	26
Language/言語 .....	26
LCD Display .....	18
LCD Display Settings .....	18
Lens .....	21, 74
Lens focal length .....	75
Lens information contacts .....	7
Lens mount index .....	7, 21
Lens Shutter Options .....	74
Lens unlock button .....	21
Link AE and AF Point .....	35
Live View .....	10, 16

## M

M mode .....	32
Macintosh .....	85
Macro  .....	30
Magnifying images .....	29
Manual Exposure .....	32
Manual focus .....	39
Manual White Balance .....	46
Memory .....	67
Memory card .....	25
Menus .....	14
MF .....	39
MF Autozoom .....	39
Microphone .....	7

- Miniature (Digital Filter) ... 59  
 Mode dial ..... 28  
 Monitor display ..... 9  
 Monochrome (Custom Image) ..... 48  
 Motion JPEG ..... 44  
 Movie Continuous AF ..... 34  
 Movie Edit ..... 62  
 Movie menu ..... 17  
 Movie mode ..... 34  
 Movie SR ..... 17  
 Moving Object  ..... 30  
 MSC ..... 77  
 Multi-exposure ..... 43  
 Multi-image display ..... 53  
 Multiple AF Points (Autofocus Method) ..... 38  
 Multi-segment metering ... 35  
 Museum  ..... 31  
 Muted (Custom Image).... 48
- N**  
 Natural (Custom Image).. 48  
 ND Filter ..... 15, 74  
 Night Scene HDR  ..... 30  
 Night Scene  ..... 30  
 Night Scene Portrait  .. 30  
 Night Snap  ..... 30  
 Noise Reduction ..... 35
- O**  
 One Push File Format .... 64  
 Operating environment.... 85
- P**  
**P** mode ..... 32  
 PC/AV terminal..... 56  
 Pet  ..... 31  
 Pixel Mapping ..... 78  
 Playback Info Display selection screen ..... 11  
 Playback menu ..... 17  
 Playback mode ..... 29  
 Playback mode palette .... 52  
 Portrait (Custom Image).. 48  
 Portrait  ..... 30  
 Posterization (Digital Filter) ..... 49, 59  
 Power ..... 26  
 Power Saving ..... 19  
 Preview ..... 33, 64  
 Program Automatic Exposure ..... 32  
 Protect ..... 68  
 Provided software..... 85  
 PTP ..... 77
- Q**  
 Quality Level..... 45  
 Quick Dial ..... 50, 66  
 Quick Macro  ..... 31  
 Quick Zoom ..... 17  
 QuickTime ..... 85
- R**  
 Radiant (Custom Image) ..... 48  
 RAW ..... 45  
 RAW Development..... 63  
 Rec. Mode menus ..... 15  
 Recordable time ..... 34  
 Recorded Pixels ..... 45  
 Recording Sound Level... 17  
 Red-eye Edit..... 59  
 Release While Charging ..... 36, 41  
 Release-priority ..... 38  
 Remote control receiver .... 7  
 Remote Control shooting ..... 42  
 Reset ..... 19, 20, 69  
 Resets the adjustment value ..... 20  
 Resize ..... 58  
 Retro (Digital Filter) ..... 59  
 Reversal Film (Custom Image) ..... 48  
 RGB Histogram Display.. 12  
 Rotating images ..... 55
- S**  
 Save as Manual WB ..... 46  
 Save Menu Location ..... 14  
 Save RAW Data ..... 16  
 Save Rotation Info ..... 55  
 Save Smart Effect ..... 66  
 Saving RAW data ..... 29  
 Scene modes ..... 30  
**SCN** mode ..... 30  
 SD Memory Card..... 25  
 Select (Autofocus Method) ..... 38  
 Select & Delete ..... 53  
 Self-timer lamp ..... 7  
 Self-timer shooting..... 41  
 Sensitivity ..... 35  
 Sensitivity Steps ..... 35  
 Sequential Numbering .... 69  
 Set-up menus ..... 18  
 Shading (Digital Filter) ..... 49, 59  
 Shadow Correction ..... 47  
 Shake Reduction ..... 16  
 Shooting ..... 28  
 Shooting Info Display selection screen..... 11  
 Shutter & Aperture Priority Automatic Exposure ..... 32  
 Shutter Priority Automatic Exposure ..... 32  
 Single Frame Shooting.... 40  
 Single image display.. 11, 29  
 Sketch (Digital Filter) ..... 59  
 Slideshow ..... 55  
 Slim (Digital Filter) .... 49, 59  
 Smart Effect..... 51  
 Soft (Digital Filter)..... 59  
 Sound ..... 34  
 Sound Effects ..... 18  
 Speaker ..... 7  
 Specifications ..... 80  
 Spot (Autofocus Method) ..... 38  
 Spot metering ..... 35  
 Stage Lighting  ..... 31  
 Standby mode ..... 10  
 Starburst (Digital Filter).... 59  
 Strap ..... 21

Sunset 	30	Video terminal .....	56
Surf & Snow 	31	Vintage Color (Smart Effect)	50
Switch .....	8	Volume label .....	27
<b>T</b>			
<b>TA</b> v mode .....	32	<b>W</b>	
Terminal cover .....	7	Warm Fade (Smart Effect)	50
Thumbnail display .....	29, 53	WARRANTY POLICY .....	95
Tone Expansion (Digital Filter) .....	49, 59	Water Color (Digital Filter)	49, 59
Tone Expansion (Smart Effect) .....	50	WB When Using Flash .....	46
Toy Camera (Digital Filter) .....	49, 59	White Balance .....	45
Tracking (Autofocus Method) .....	38	Windows .....	85
Tripod socket .....	7	Wireless LAN .....	69
<b>Tv</b> mode .....	32	World Time .....	67
<b>U</b>			
Unicolor Bold (Digital Filter) .....	49, 59	<b>Z</b>	
Unicolor Bold (Smart Effect) .....	50	Zoom lens .....	28
Updating firmware .....	19		
USB .....	57		
USB Connection .....	77, 85		
USER .....	50, 66		
User registration .....	6		
<b>V</b>			
Vibrant (Custom Image) ..	48		
Vibrant Color Enhance (Smart Effect) .....	50		
Video output format .....	56		

## For Using Your Camera Safely

We have paid close attention to the safety of this camera. When using this camera, we request your special attention regarding items marked with the following symbols.



### Warning

This symbol indicates that ignoring this item could cause serious personal injuries.



### Caution

This symbol indicates that ignoring this item could cause minor or medium personal injuries, or loss of property.

## About the Camera



### Warning

- Do not disassemble or modify the camera. High voltage areas are present inside the camera, with the risk of electric shock.
- If the camera interior is exposed due to dropping or otherwise damaging the camera, never touch the exposed portion. There is a risk of electric shock.
- Do not aim the camera at the sun or other strong light sources when taking pictures or leave the camera sitting in direct sunlight with the lens cap off. Doing so may cause the camera to malfunction or cause a fire.
- Do not look at the sun or other strong light sources through a lens. Doing so may lead to a loss of eyesight or cause vision to be impaired.
- If any irregularities occur during use, such as smoke or a strange odor, stop use immediately, remove the battery or the AC adapter, and contact your nearest service center. Continued use can cause a fire or electrical shock.



### Caution

- Do not place your finger over the flash when discharging the flash. You may burn yourself.
- Do not cover the flash with clothing when discharging the flash. Discoloration may occur.
- Some portions of the camera heat up during use. There is a risk of low temperature burns when holding such portions for long periods.

- Should the monitor be damaged, be careful of glass fragments. Also, be careful not to allow the liquid crystal to get on your skin or in your eyes or mouth.
- Depending on your individual factors or physical condition, the use of the camera may cause itching, rashes or blisters. In case of any abnormality, stop using the camera and get medical attention immediately.

## About the Battery Charger and AC Adapter



### Warning

- Always use the battery charger and AC adapter exclusively developed for this camera, with the specified power and voltage. Using a battery charger or AC adapter not exclusive to this camera, or using the exclusive battery charger or AC adapter with an unspecified power or voltage can cause a fire, electric shock, or camera breakdown. The specified voltage is 100 - 240V AC.
- Do not disassemble or modify the product. This can cause a fire or electrical shock.
- If the generation of smoke or strange odor from the product or other abnormality occurs, immediately discontinue using and consult your nearest service center. Continued use can cause a fire or electrical shock.
- If water should happen to get inside the product, consult your nearest service center. Continued use can cause a fire or electrical shock.
- If you see a lightning flash or hear thunder during use of the battery charger or AC adapter, unplug the power plug and discontinue using. Continued use can cause damage to the product, fire or electrical shock.
- Wipe off the power plug if it should become covered with dust. Accumulated dust may cause a fire.
- To reduce the risk of hazards, use only CSA/UL certified power supply cord set, cord is Type SPT-2 or heavier, minimum NO.18 AWG copper, one end with a molded-on male attachment plug cap (with a specified NEMA configuration), and the other is provided with a molded-on female connector body (with a specified IEC nonindustrial type configuration) or the equivalent.



### Caution

- Do not place or drop heavy objects on or forcefully bend the AC plug cord. Doing so may damage the cord. Should the AC plug cord be damaged, consult your nearest service center.

- Do not touch or short-circuit the terminal area of the AC plug cord while the cord is plugged in.
- Do not handle the power plug with wet hands. This can cause an electric shock.
- Do not drop the product, or subject it to violent impact. This can cause the product to breakdown.
- Do not use the battery charger D-BC68P to charge batteries other than the rechargeable lithium-ion battery D-LI68. Attempting to charge other types of batteries may cause an explosion or heating, or may damage the battery charger.

## About the Rechargeable Lithium-ion Battery

### Warning

- If any leakage from the battery should come in contact with your eyes, do not rub them. Flush your eyes with clean water and get medical attention immediately.

### Caution

- Only use the specified battery with this camera. Use of other batteries may cause an explosion or fire.
- Do not disassemble the battery. Disassembling the battery may cause an explosion or leakage.
- Remove the battery from the camera immediately if it becomes hot or begins to smoke. Be careful not to burn yourself during removal.
- Keep wires, hairpins, and other metal objects away from the + and - contacts of the battery.
- Do not short the battery or dispose of the battery in fire. This can cause an explosion or fire.
- If any leakage from the battery should come in contact with skin or clothing, it may cause irritation to the skin. Wash the affected areas thoroughly with water.
- Precautions for D-LI68 Battery Usage:
  - USE SPECIFIED CHARGER ONLY.
  - DO NOT INCINERATE.
  - DO NOT DISASSEMBLE.
  - DO NOT SHORT CIRCUIT.
  - DO NOT EXPOSE TO HIGH TEMP. (140°F / 60°C)

## Keep the Camera and its Accessories out of the Reach of Small Children

### Warning

- Do not place the camera and its accessories within the reach of small children.
  1. If the product falls or is operated accidentally, it may cause serious personal injuries.
  2. Wrapping the strap around a neck may cause suffocation.
  3. To avoid the risk of a small accessory such as the battery or memory cards from being swallowed by mistake, keep them out of the reach of small children. Seek medical attention immediately if an accessory is accidentally swallowed.

## Care to be Taken During Handling

### Before Using Your Camera

- When the camera has not been used for a long time, confirm that it is still working properly, particularly prior to taking important pictures (such as at a wedding or when traveling). Contents of the recording cannot be guaranteed if recording, playback or transferring your data to a computer, etc. is not possible due to a malfunction of your camera or recording media (memory cards), etc.

### About the Battery and Charger

- To keep the battery in optimum condition, avoid storing it in a fully charged state or in high temperatures.
- If the battery is left inserted and the camera is not used for a long time, the battery will over-discharge and shorten the battery's life.
- Charging the battery a day before use or on the day of use is recommended.
- The AC plug cord provided with this camera is developed exclusively for the battery charger D-BC68P. Do not use it with other devices.

### Precautions on Carrying and Using Your Camera

- Do not subject the camera to high temperatures or high humidity. Do not leave the camera in a vehicle, as the temperature can get very high.
- Do not subject the camera to strong vibrations, shocks, or pressure. Use a cushion to protect the camera from vibrations of motorcycles, automobiles, or ships.
- The temperature range for camera use is 0°C to 40°C (32°F to 104°F).
- The monitor may appear black at high temperatures, but will return to normal at normal temperatures.
- The monitor may respond more slowly at low temperatures. This is due to liquid crystal properties, and is not a malfunction.

- Sudden temperature changes will cause condensation on the inside and outside of the camera. Place the camera in your bag or a plastic bag, and remove it after temperatures of the camera and surroundings are equalized.
- Avoid contact with garbage, mud, sand, dust, water, toxic gases, or salt. These could cause the camera to breakdown. Wipe the camera to dry off any rain or water drops.
- Do not press on the monitor with excessive force. This could cause it to break or malfunction.
- Be careful not to overtighten the screw in the tripod socket when using a tripod.

### Cleaning Your Camera

- Do not clean the camera with organic solvents such as thinner, alcohol, and benzine.
- Use a lens brush to remove dust accumulated on the lens. Never use a spray blower for cleaning as it may damage the lens.
- Please contact your nearest service center for professional cleaning of the CMOS sensor. (This will involve a fee.)
- Periodic inspections are recommended every one to two years to maintain high performance.

### Storing Your Camera

- Do not store the camera with preservatives or chemicals. Storage in high temperatures and high humidity can cause mold to grow on the camera. Remove the camera from its case and store it in a dry and well-ventilated place.
- Avoid using or storing the camera where it may be exposed to static electricity or electrical interference.
- Avoid using or storing the camera in direct sunlight or in locations where it may be exposed to rapid changes in temperature or to condensation.

## About SD Memory Cards

- The SD Memory Card is equipped with a write-protect switch. Setting the switch to LOCK prevents new data from being recorded on the card, the stored data from being deleted, and the card from being formatted by the camera or computer.
- The SD Memory Card may be hot when removing the card immediately after using the camera.
- Do not remove the SD Memory Card or turn off the power while the card is being accessed. This may cause the data to be lost or the card to be damaged.
- Do not bend the SD Memory Card or subject it to violent impact. Keep it away from water and store away from high temperatures.
- Do not remove the SD Memory Card while formatting. The card may be damaged and become unusable.
- Data on the SD Memory Card may be deleted in the following circumstances. We do not accept any liability for data that is deleted if
  1. the SD Memory Card is mishandled by the user.
  2. the SD Memory Card is exposed to static electricity or electrical interference.
  3. the SD Memory Card has not been used for a long time.
  4. the SD Memory Card or the battery is removed while the card is being accessed.
- If the SD Memory Card is not used for a long time, the data on the card may become unreadable. Be sure to regularly make a backup of important data on a computer.
- Format new SD Memory Cards. Also format SD Memory Cards previously used with other cameras.
- Please note that deleting data stored on an SD Memory Card, or formatting an SD Memory Card does not completely erase the original data. Deleted data can sometimes be recovered using commercially available software. If you are going to discard, give away or sell your SD Memory Card, you should ensure that the data on the card is completely deleted or the card itself is destroyed if it contains any personal or sensitive information.
- The data on your SD Memory Card should be managed at your own risk.

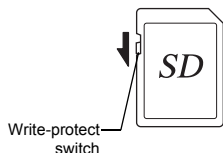

## About Eye-Fi Cards

- An SD Memory Card with a built-in wireless LAN ("Eye-Fi card") can be used with this camera.
- Use of an access point and an Internet connection are required for transferring images via wireless LAN. For details, refer to the Eye-Fi website. (<http://www.eye.fi>)
- Update your Eye-Fi card to the latest firmware before using it.
- Set [Eye-Fi Communication] of [Eye-Fi] to [OFF], or do not use an Eye-Fi card in a location where the use of wireless LAN devices is restricted or prohibited, such as airplanes.
- Eye-Fi cards can be used only in the country in which the card was purchased. Please observe all local laws governing the Eye-Fi card usage.
- This camera features a function to enable/disable the communication function of the Eye-Fi card, however, we do not guarantee the operability of all Eye-Fi card functions.
- Refer to the Eye-Fi card manual for details on how to use the card.
- Please contact the Eye-Fi card manufacturer regarding any malfunctions or problems concerning Eye-Fi cards.

## Trademarks

Microsoft, Windows and Windows Vista are registered trademarks of Microsoft Corporation in the United States of America and other countries. Macintosh, Mac OS, and QuickTime are trademarks of Apple Inc., registered in the U.S. and other countries.

Intel, Intel Core, and Pentium are trademarks of Intel Corporation in the U.S. and/or other countries.

SDXC Logo is a trademark of SD-3C, LLC.

Eye-Fi, the Eye-Fi logo and Eye-Fi *connected* are trademarks of Eye-Fi, Inc.

This product includes DNG technology under license by Adobe Systems Incorporated.

The DNG logo is either a registered trademark or trademark of Adobe Systems Incorporated in the United States and/or other countries.

HDMI, the HDMI logo and High-Definition Multimedia Interface are trademarks or registered trademarks of HDMI Licensing, LLC in the United States and/or other countries.

All other trademarks are the property of their respective owners.

This product supports PRINT Image Matching III. PRINT Image Matching enabled digital still cameras, printers and software help photographers to produce images more faithful to their intentions. Some functions are not available on printers that are not PRINT Image Matching III compliant. Copyright 2001 Seiko Epson Corporation. All Rights Reserved. PRINT Image Matching is a trademark of Seiko Epson Corporation. The PRINT Image Matching logo is a trademark of Seiko Epson Corporation.



## AVC Patent Portfolio License

This product is licensed under the AVC Patent Portfolio License for the personal use of a consumer or other uses in which it does not receive remuneration to (i) encode video in compliance with the AVC standard ("AVC video") and/or (ii) decode AVC video that was encoded by a consumer engaged in a personal activity and/or was obtained from a video provider licensed to provide AVC video. No license is granted or shall be implied for any other use.

Additional information may be obtained from MPEG LA, L.L.C. See <http://www.mpegla.com>.



## WARRANTY POLICY

All our cameras purchased through authorized bona fide photographic distribution channels are guaranteed against defects of material or workmanship for a period of twelve months from the date of your purchase. Service will be rendered, and defective parts will be replaced without cost to you within that period, provided the camera does not show evidence of impact, sand or liquid damage, mishandling, tampering, battery or chemical corrosion, operation contrary to operating instructions, or modification by an unauthorized repair shop. The manufacturer or its authorized representatives shall not be liable for any repair or alterations except those made with its written consent and shall not be liable for damages from delay or loss of use or from other indirect or consequential damages of any kind, whether caused by defective material or workmanship or otherwise; and it is expressly agreed that the liability of the manufacturer or its representatives under all guarantees or warranties, whether expressed or implied, is strictly limited to the replacement of parts as hereinbefore provided. No refunds will be made on repairs by non-authorized service facilities.

### Procedure During 12-month Warranty Period

Any camera which proves defective during the 12-month warranty period should be returned to the dealer from whom you purchased the camera or to the manufacturer. If there are no representatives of the manufacturer in your country, send the camera to the manufacturer, with postage prepaid. In this case, it will take a considerable length of time before the camera can be returned to you owing to the complicated customs procedures required. If the camera is covered by warranty, repairs will be made and parts replaced free of charge, and the

camera will be returned to you upon completion of servicing. If the camera is not covered by warranty, regular charges of the manufacturer or of its representatives will apply. Shipping charges are to be borne by the owner. If your camera was purchased outside of the country where you wish to have it serviced during the warranty period, regular handling and servicing fees may be charged by the manufacturer's representatives in that country. Notwithstanding this, your camera returned to the manufacturer will be serviced free of charge according to this procedure and warranty policy. In any case, however, shipping charges and customs clearance fees to be borne by the sender. To prove the date of your purchase when required, please keep the receipt or bills covering the purchase of your camera for at least a year. Before sending your camera for servicing, please make sure that you are sending it to the manufacturer's authorized representatives or their approved repair shops, unless you are sending it directly to the manufacturer. Always obtain a quotation for the service charge, and only after you accept the quoted service charge, instruct the service station to proceed with the servicing.

- **This warranty policy does not affect the customer's statutory rights.**
- **The local warranty policies available from our distributors in some countries can supersede this warranty policy. Therefore, we recommend that you review the warranty card supplied with your product at the time of purchase, or contact our distributor in your country for more information and to receive a copy of the warranty policy.**

**For customers in USA****STATEMENT OF FCC COMPLIANCE**

This device complies with Part 15 of the FCC Rules. Operation is subject to the following two conditions: (1) This device may not cause harmful interference, and (2) this device must accept any interference received, including interference that may cause undesired operation.

Changes or modifications not approved by the party responsible for compliance could void the user's authority to operate the equipment.

This equipment has been tested and found to comply with the limits for a Class B digital device, pursuant to part 15 of the FCC Rules.

These limits are designed to provide reasonable protection against harmful interference in a residential installation. This equipment generates, uses and can radiate radio frequency energy and, if not installed and used in accordance with the instructions, may cause harmful interference to radio communications. However, there is no guarantee that interference will not occur in a particular installation.

If this equipment does cause harmful interference to radio or television reception, which can be determined by turning the equipment off and on, the user is encouraged to try to correct the interference by one or more of the following measures:

- Reorient or relocate the receiving antenna.
- Increase the separation between the equipment and receiver.
- Connect the equipment into an outlet on a circuit different from that to which the receiver is connected.

\* Consult the dealer or an experienced radio/TV technician for help.

**For customers in Canada**

This Class B digital apparatus complies with Canadian ICES-003.

**Pour les utilisateurs au Canada**

Cet appareil numérique de la classe B est conforme à la norme NMB-003 du Canada.

**FOR CALIFORNIA, U.S.A. ONLY**

Perchlorate Material-special handling may apply.

The lithium battery used in this camera contains perchlorate material, which may require special handling.

See [www.dtsc.ca.gov/hazardouswaste/perchlorate](http://www.dtsc.ca.gov/hazardouswaste/perchlorate)

# Declaration of Conformity

According to 47CFR, Parts 2 and 15 for  
Class B Personal Computers and Peripherals

We: RICOH IMAGING AMERICAS  
CORPORATION

Located at: 633 17<sup>th</sup> Street, Suite 2600  
Denver, Colorado 80202 U.S.A.  
Phone: 800-877-0155  
FAX: 303-790-1131

Declare under sole responsibility that the product identified herein complies with 47CFR Parts 2 and 15 of the FCC rules as a Class B digital device. Each product marketed is identical to the representative unit tested and found to be compliant with the standards. Records maintained continue to reflect the equipment being produced can be expected to be within the variation accepted, due to quantity production and testing on the statistical basis as required by 47CFR §2.909. Operation is subject to the following two conditions: (1) This device may not cause harmful interference, and (2) This device must accept any interference received, including interference that may cause undesired operation. The above named party is responsible for ensuring that the equipment complies with the standards of 47CFR §15.101 to §15.109.

Product Name: Digital Camera  
Model Number: PENTAX Q-S1  
Contact person: Customer Service Manager  
Date and Place: August, 2014, Colorado

## Information for Users on Collection and Disposal of Old Equipment and Used Batteries



### 1. In the European Union

These symbols on the products, packaging and/or accompanying documents mean that used electrical and electronic equipment and batteries should not be mixed with general household waste.

Used electrical/electronic equipment and batteries must be treated separately and in accordance with legislation that requires proper treatment, recovery and recycling of these products.



By disposing of these products correctly you will help ensure that the waste undergoes the necessary treatment, recovery and recycling and thus prevent potential negative effects on the environment and human health which could otherwise arise due to inappropriate waste handling.

If a chemical symbol is added beneath the symbol shown above, in accordance with the Battery Directive, this indicates that a heavy metal (Hg = Mercury, Cd = Cadmium, Pb = Lead) is present in the battery at a concentration above an applicable threshold specified in the Battery Directive.

For more information about collection and recycling of used products, please contact your local authorities, your waste disposal service or the point of sale where you purchased the products.

## 2. In other countries outside the EU

These symbols are only valid in the European Union. If you wish to discard used products, please contact your local authorities or dealer and ask for the correct method of disposal.

For Switzerland: Used electrical/electronic equipment can be returned free of charge to the dealer, even when you don't purchase a new product. Further collection facilities are listed on the home page of [www.swico.ch](http://www.swico.ch) or [www.sens.ch](http://www.sens.ch).



The CE Mark is a Directive conformity mark of the European Union.

**Memo**

**Memo**

**Memo**

**RICOH IMAGING COMPANY, LTD.**

2-35-7, Maeno-cho, Itabashi-ku, Tokyo 174-8639, JAPAN  
(<http://www.ricoh-imaging.co.jp>)

**RICOH IMAGING EUROPE S.A.S** 112 Quai de Bezons, B.P. 204, 95106 Argenteuil Cedex, FRANCE  
(<http://www.ricoh-imaging.fr>)

**RICOH IMAGING DEUTSCHLAND GmbH** Am Kaiserkai 1, 20457 Hamburg, GERMANY  
(<http://www.ricoh-imaging.de>)

**RICOH IMAGING UK LTD.** PENTAX House, Heron Drive, Langley, Slough, Berks SL3 8PN, U.K.  
(<http://www.ricoh-imaging.co.uk>)

**RICOH IMAGING AMERICAS CORPORATION** 633 17th Street, Suite 2600, Denver, Colorado 80202, U.S.A.  
(<http://www.us.ricoh-imaging.com>)

**RICOH IMAGING CANADA INC.** 520 Explorer Drive Suite 300, Mississauga, Ontario, L4W 5L1, CANADA  
(<http://www.ricoh-imaging.ca>)

**RICOH IMAGING CHINA CO., LTD.** 23D, Jun Yao International Plaza, 789 Zhaojiabang Road, Xu Hui District, Shanghai, 200032, CHINA  
(<http://www.ricoh-imaging.com.cn>)

<http://www.ricoh-imaging.co.jp/english>

- Specifications and external dimensions are subject to change without notice.