

PENTAX®

ZX-5

OPERATING MANUAL

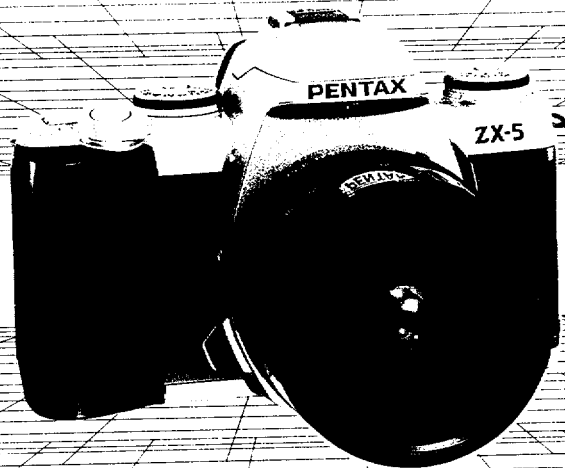

Congratulations on your purchase of this camera and welcome to the exciting world of Pentax autofocus photography! This compact and light weight camera is an autofocus SLR camera that offers higher levels of sophistication and performance. Incorporating a broad range of advanced technologies and highly accurate automation, this camera will perform superbly for the most exacting photographer.

The major features of this camera are :





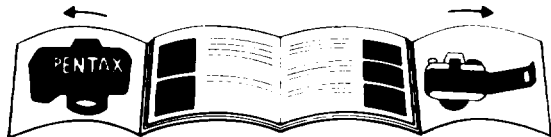

- 3-point autofocus system
- 3 different switchable metering systems
- Automatic on/off flash function with in the built-in flash popped up position

Read this instruction manual carefully to get a full explanations for operations before use.



The names of the camera's working parts are listed on the front and back flaps in this operating manual. Keep the flaps unfolded for quick reference while reading this manual.

Icon indicators used in this manual

Operation direction	
Automatic operation	
Attention	
Lamp blinking	
Correct	
Incorrect	

Lenses and accessories produced by other manufacturers are not made to our precise specifications and therefore may cause difficulties with or actual damage to your Pentax camera. We do not assume any responsibility or liability for difficulties resulting from the use of lenses and accessories made by other manufacturers.

NAMES OF WORKING PARTS I

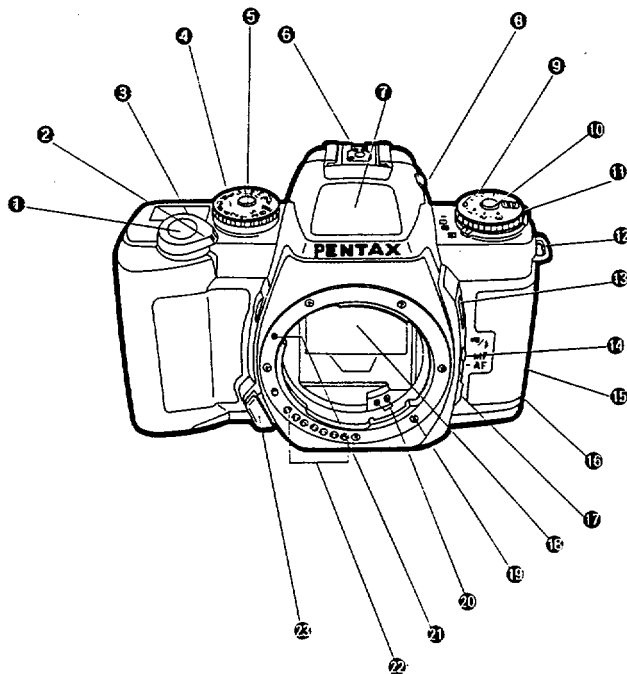

- ❶ Shutter release button
- ❷ Drive mode switch (p.21,45)
- ❸ LCD panel (p.6)
- ❹ Shutter dial
- ❺ Shutter dial lock button
- ❻ Hot shoe (p.76)
- ❼ Built-in flash (p.38)
- ❽ Flash pop-up button (p.38)
- ❾ Exposure compensation dial (p.64,75)
- ❿ Exposure compensation release button (p.64,75)
- ⓫ Metering mode switch (p.30,68,69)
- ⓬ Strap lug (p.13)
- ⓭ Release socket (p.63)
- ⓮ Multi-function button (p.41,43,70)
- ⓯ Back cover release lever (p.22)
- ⓰ Mid-roll rewind button (p.26)
- ⓱ Focus mode switch (p.35,47)
- ⓲ Mirror
- ⓳ AF coupler
- ⓴ Power supply contact
- ⓵ Lens mount index (p.18)
- ⓶ Lens information contact
- ⓷ Lens lock button (p.19)

FOR SAFE USE OF YOUR CAMERA

Although we have carefully designed this camera for safe operation, please be sure to follow precautions given on this page.

 **WARNING** This mark indicates precautions that, if not followed, could result in serious injury to the operator.

 **CAUTION** This mark indicates precautions that, if not followed, could result in minor or medium injury to the operator or damage to the equipment.

 **WARNING**

- The electronic circuits inside the camera contain high voltage working parts. Never attempt to disassemble the camera yourself.
- Never touch internal parts of the camera if they become exposed from dropping the camera or for some other reason, as there is danger of electric shock.
- Wrapping the strap around your neck is dangerous. Make sure that small children do not get the strap caught around their neck.
- Do not look directly at the sun through the camera, as viewing the sun for an extended period may damage your eyes.
- Be sure to store batteries out of the reach of children. Seek medical assistance immediately if accidentally swallowed.

 **CAUTION**

- Do not use the flash near anyone's eyes, as it may hurt them. Be particularly careful with the flash around infants.
- Never try to disassemble, short or recharge the battery. Also, do not dispose of the battery in fire, as it may explode.
- Remove the batteries from the camera immediately if they become hot or begin to smoke. Be careful not to burn yourself during removal.

PRECAUTIONS FOR YOUR CAMERA

1

Your Pentax camera is a high-precision mechanism. Handle it with great care.

Precautions when taking pictures

- Do not use the camera where it may come in contact with rain, water, or any other liquid, because the camera is not weather, water, or liquid resistant. Should the camera get wet from rain, splashing water, or any other liquid, wipe it off immediately with a dry soft cloth.
- Do not drop the camera or allow it to hit solid objects. If the camera suffers a severe shock or impact, take it to a Pentax service center for inspection.
- Be careful not to subject the camera to strong vibrations, shock or pressure. Use a cushion to protect the camera when carrying it in a motorcycle, car, boat, etc.
- Condensation on the interior or exterior of the camera may be extremely harmful to the camera mechanism as it may cause rust. Furthermore, if the camera is taken from warm temperature to a sub-freezing one or vice versa, the formation of icelets may cause damage. In such a case, put the camera into a case or plastic bag so that any changes in temperature difference is minimized. Do not remove it from the bag until temperature has stabilized.

- Regular size color prints may cut off what appears on the extreme edges of the film frame. Compose your picture with a margin of safety at the edges.

Precautions for storage

- Avoid leaving the camera for extended periods in places where the humidity and temperature are very high, such as in a car.
- Do not store the camera in a closet with moth balls or in a area where chemicals are handled. Store it in a place with good dry air circulation to prevent the growth of fungus.

Precautions for proper care

- Never touch the shutter curtain or mirror with your finger or any other object.
- Use a blower and lens brush to remove dust accumulated on the lens or viewfinder.
- Never use solvents such as paint thinner, alcohol or benzene to clean the camera.
- Electrical problems may often be caused by water, dirt or dust at points of electrical contact. Also check for battery leakage, traces of dirt or grease, or corrosion due to salinity or gas. If you cannot correct the problems, have your camera inspected at a Pentax service center. Repairs of this nature are not covered under the terms of the warranty and charges may be assessed.

Other precautions

- Temperature range at which this camera functions properly is 50°C to -10°C (122°F to 14°F).
- A camera which has been submerged in water cannot usually be repaired. If such an accident should occur, it is advisable to contact a Pentax Service Center immediately.
- To maintain optimum performance, it is recommended that the camera be inspected every one or two years. If the camera has not been used for an extended period, or is being prepared for an important photographic session, it is recommended that you have the camera inspected or test shoot with it.
- Repair made necessary due to usage of this product in an industrial or commercial application may not be covered under the term of the Pentax warranty.
- The PENTAX warranty provides only for the repair of defects in materials or workmanship. Damage of any kind cannot be repaired at no charge under the terms of the warranty. If the difficulty is caused as a direct result of the product being used in conditions as outlined in the "Precautions for Your Camera" section or any other operation contrary to the instructions outlined in this manual, charges will be assessed or a repair quotation will be provided.

PRECAUTIONS FOR BATTERY

- Use two 3V lithium batteries (CR2 type).
- Misuse of the battery can cause hazards such as leakage, overheating, explosions, etc. The battery should be inserted with the "+" and "-" sides facing correctly.
- Battery performance may be temporarily hindered in low temperatures, but will recover in normal temperatures.
- Keep a spare batteries on hand for replacement convenience when shooting outdoors or while traveling.
- If the built-in flash is used continuously, the battery may become warm, but it does not mean that the battery is faulty; it is one of the battery's characteristics.
- Replace the batteries at the same time. Do not mix battery brands, type or an old battery with a new one. It may cause explosion or overheating.



Focusing

- Taking a picture when the main subject is not in the Autofocus frame.p.65,66
- Changing in-focus range.p.56
- Focusing on a particular spot.p.65



Flash photography

- Taking a picture in low light situations.p.38
- Minimizing the red-eye effect.p.41
- Taking a portrait when the subject is in the shade. p.80
- Taking a picture of people with night scenery in the background.p.81
- Taking a picture in a roomy place such as a church or reception hall.p.76



Exposure modes

- Taking a picture with the desired exposure setting.p.60,64
- Taking a picture in strong backlit situations with the main subject in the shadow.p.80



Zooming the lens

- Making a subject larger or smaller.p.31



Taking pictures of people in various situations

- Putting yourself into a picture.p.45
- Taking a picture in strong backlit situations with the main subject in the shade.p.81
- Taking a picture of people with night scenery in the background.p.81



Landscape photography

- Taking a picture of night scenery.p.62
- Taking a picture of people with night scenery.p.81



Others

- Taking a picture of a fast moving subject.p.37,58
- Taking a horizontally dynamic panoramic picture. ...p.52
- Taking consecutive pictures of a moving subject. p.45







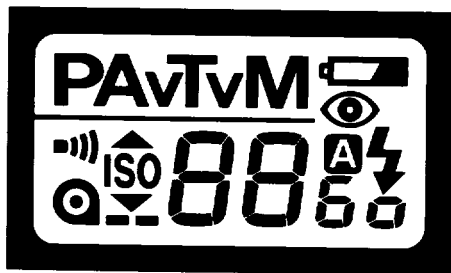

TABLE OF CONTENTS

Names of working parts	Flaps	Using the shutter release button	20
For safe use of your camera	Inside cover	Turning on the power	21
Precautions for your camera	1	Film loading	22
Precautions for battery	2	Unloading film	25
LCD panel indication	6	Adjusting the viewfinder diopter	27
Viewfinder indication	7		
Easy to use! (For beginners)	8	II BASIC OPERATION (SHOOTING)	28-43
Cameras and lens mounts	10	Using the Programmed Mode	28
Camera functions available with various lenses	11	Using the Multi(6)- segment metering mode	30
How to use this operating manual	12	Using zoom lenses	31
		Holding the camera	34
I . BASIC OPERATION (PREPARATION) 13-27		Selecting the Autofocus Mode	35
Attaching the camera strap	13	Taking a picture	36
Loading the batteries	14	Basic operation for the Built-in RetractableTTL	
• When the battery is exhausted	17	Flash (RTF)	38
Attaching the lens	18	• Red-eye Reduction Flash Function	41
		• Automatic flash function	43

III. ADVANCED OPERATION	44-88
Selecting a Drive Mode	44
• Consecutive Frame Mode	45
• Self-Timer Mode	45
Manual focusing	47
• Using Snap-in focus function	49
Taking Panorama format pictures	52
Selecting an Exposure Mode	54
• Programmed AE Mode	54
• Aperture-Priority AE Mode	56
• Shutter-Priority AE Mode	58
• Metered Manual Mode	60
• Bulb Exposure Mode	62
About Exposure Compensation	64
Spot AF Mode	65
• Focus Lock Function	66
Switching the Metering Mode	68
Turning off the audible PCV signal	70
Advanced operation for the Built-in Retractable TTL Flash (RTF)	71
Compatibility of F and FA lenses with the built-in flash	73
Setting the film speed (ISO) manually	75
Using a Pentax Dedicated External Flash	76
• Contrast-Control-Sync Flash Photography	78
Daylight-sync shooting	80
Slow-speed-sync shooting	81
ACCESSORIES (OPTION)	82
Camera case	84
Effects of aperture and shutter speed	85
Depth of field	87
The infrared index	88
IV. OTHERS	89-95
Troubleshooting	90
Specifications	92
Warranty policy	94

LCD PANEL INDICATION



- P** : Programmed AE (p.54)
- Av** : Aperture-Priority AE (p.56)
- Tv** : Shutter-Priority AE (p.58)
- M** : Metered Manual (p.60)
-  : Red-Eye Reduction Flash Indication (p.41)
-  : Flash Information (p.38,40)
-  : Automatic Flash function Information (p.43)
- 88** : Exposure Counter (p.24)
-  : Film Status Information (p.24,25)
-  : Battery Exhaustion Warning (p.17)
-  : Audible PCV Signal (p.70)
-  : Film Speed Setting Signals (p.75)
- 88** : Film Speed Information (p.75)

LCD (Liquid-Crystal Display)

When the LCD is exposed to high temperatures over about 60°C it may blacken, but when the temperature normalizes, it should return to normal.

VIEWFINDER INDICATION

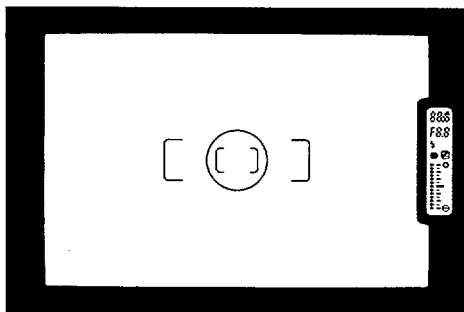

- When the format is switched to panorama, the viewfinder switches to the horizontal panoramic format frame. For details on the panoramic format picture, see page 52.

[] : 3-point AF Frame (p.36)

[] : Spot AF Frame (p.65)

2000 : Shutter Speed (p.54,57,59,61)

F3.2 : Aperture Value (p.54,57,59,61)

⚡ : Flash Status Information (p.38,40)

○ : In-focus Indicator (p.36)

☑ : Exposure Compensation (p.64)

0 1 2 3 4 5 6 7 8 : Bar Graph (p.61,64)

○ : Spot metering area (p.68)

EASY TO USE (For beginners)

1. Loading the batteries

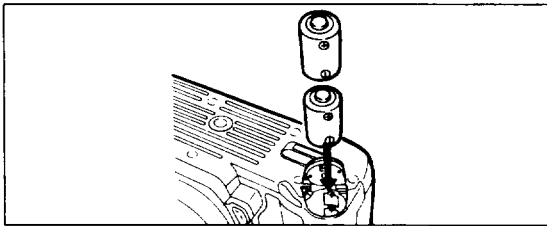

Open the battery chamber cover by using a coin. Load two batteries (CR2 type) according to the markings (+, -) in the battery chamber. (See page 14.)

2. Attaching the lens

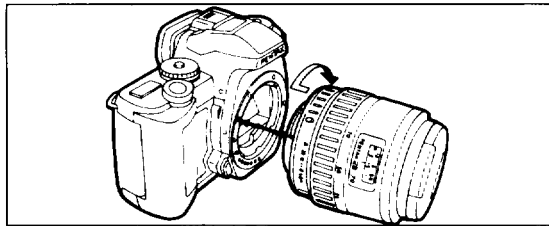

Align the red indexes on the lens and camera. Turn the lens to the right until it seats with a click. (See page 18.)

3. Positioning the aperture ring

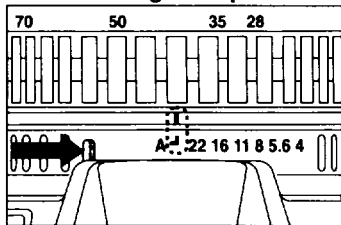

While holding down the aperture-A-lock button, turn the lens aperture ring to the [A] position. (See page 29.)

4. Setting the shutter dial

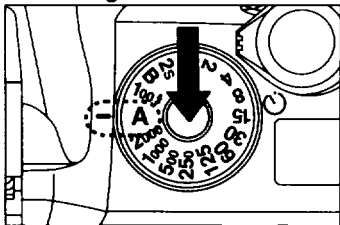

While holding down the shutter dial lock button, turn the shutter dial to [A]. (See page 29.) The exposure mode will be set at the Programmed AE Mode.

5. Turning on the power

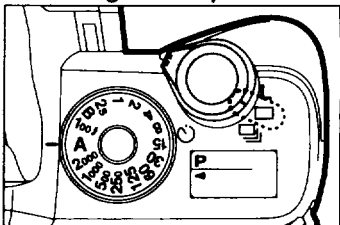

Set the drive mode switch to [A]. (See page 21.)

6. Loading film

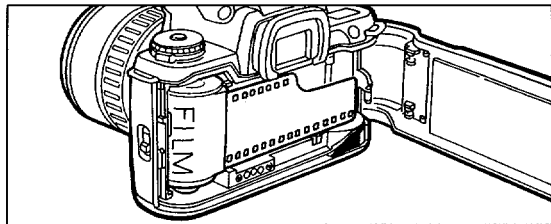

Open the back cover, insert a roll of film, align the end of the film leader with the red mark, and close the back cover. The film should advance to the first frame automatically. (See page 22.)

8. Composing the scene with the zoom ring

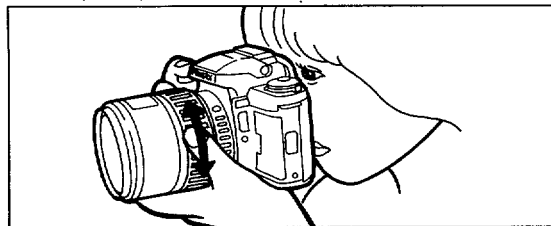

While looking through the viewfinder, turn the zoom ring to the right or left until you obtain the desired composition. (See page 31.)

7. Selecting the Autofocus Mode

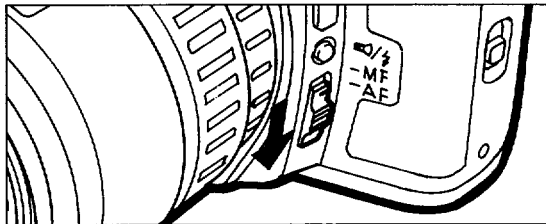

Set the focus mode switch to [AF]. (See page 35.)

9. Focus on the subject and shoot

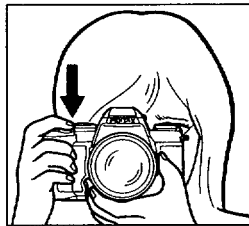

Focus [()] on the subject. Depress the shutter release button halfway to lock focus, and then depress it fully to take a photo. (See page 36.)

CAMERAS AND LENS MOUNTS

Lens Mount and Camera Body Compatibility Chart

Mount Type	Lens Type	Camera Model
(A) K _{AF2} -mount	Pentax-FA lens	MZ-5/ZX-5,Z-1 _p /PZ-1 _p ,Z-1/PZ-1, Z-10/PZ-10,Z-20/PZ-20,Z-70/PZ-70
(B) K _{AF} -mount	Pentax-F lens	SFX _w /SF1 _w , SF7/SF10, SFX/SF-1
(C) K _A mount	Pentax-A lens	Super-A/Super Program, P30 _w /P3 _w , P30 _r
(D) K-mount	Pentax-M lens and Pentax lens	LX,K1000
(E) Screw mount	SMC TAKUMAR lens	ESII,SP

(A) through (D): basic K-mount (bayonet) lenses.

(A) and (B): autofocus lenses.

(C) through (E): non-AF (manual-focus) lenses.

(E): A screw mount lens can be fitted to the camera (A) through (D) with the optional Pentax "Mount Adapter K".

(A) through (C): have "A"(auto) position on the lens aperture ring.

Pentax FA lenses incorporate new contacts to exchange information between the camera and lens for power zoom. Pentax FA lenses operate on existing K-mount cameras. Pentax FA lenses incorporate new contacts as follows:

- Power supply contacts
- AF coupler
- Lens-information contacts

K-Mount Lens Compatibility Chart

K _{AF2} -mount lens			
<ul style="list-style-type: none"> • Power supply contacts • AF coupler • Lens information contacts 			
K _{AF} -mount lens		K _A -mount lens	
<ul style="list-style-type: none"> • AF coupler • Lens-information contacts 		<ul style="list-style-type: none"> • Lens-information contacts 	
			K-mount lens

CAMERA FUNCTIONS AVAILABLE WITH VARIOUS LENSES

Function	Lens [Mount type]	FA lens [K _{AF2}]	F lens [K _{AF}]	A lens [K _A]	M lens [K]	S lens [Screw]
Autofocus (Lens only)		○	○	×	×	×
(Lens with AF Adapter 1.7X)		-	-	○*1	○*1	×
Manual focus (with FI) *2		○*3	○*3	○*3	○*3	×
(with Matte field)		○	○	○	○	○
Power zoom		○*4	×	×	×	×
Image size tracking		×	×	×	×	×
Zoom clip		×	×	×	×	×
Auto zoom effect		×	×	×	×	×
Programmed AE		○*5	○*5	○	×	×
Aperture-Priority AE		○	○	○	○	○
Shutter-Priority AE		○*5	○*5	○	×	×
Manual Exposure		○	○	○	○	○
Programmed TTL Auto Flash		○	○	○	×	×
TTL Auto Flash		○	○	○	○	○
Multi(6)-segment metering		○	○	○	×	×
Approx. f-stop indication		○	○	×	×	×

- Notes:**
- * 1. Lenses with a maximum aperture of $f/2.8$ or larger. (See AF Adapter operating manual.)
 - * 2. Manual focusing using the focus indicator (FI) [○] in the viewfinder.
 - * 3. Lenses with a maximum aperture of $f/5.6$ or larger.
 - * 4. Pentax-FA zoom lenses only.
 - * 5. Exception of Pentax-F and FA Soft 85mm/ $f2.8$.
 - * 6. The center-weighted metering or Spot metering is used instead of the multi-(6) segment metering mode.

12 HOW TO USE THIS OPERATING MANUAL

This manual is organized into the following sections, allowing you to optimize the use of the camera:

A rectangular callout box with a double-line border and a drop shadow. A white circle is at the top left, with a line connecting it to the top-left corner of the box.

**I. BASIC OPERATION
(PREPARATION) Page 13 - 27**

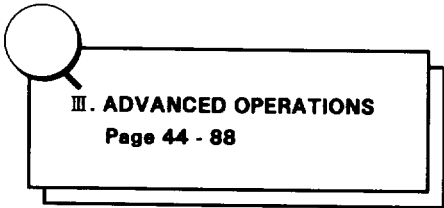
A rectangular callout box with a double-line border and a drop shadow. A white circle is at the top left, with a line connecting it to the top-left corner of the box.

**III. ADVANCED OPERATIONS
Page 44 - 88**

A rectangular callout box with a double-line border and a drop shadow. A white circle is at the top left, with a line connecting it to the top-left corner of the box.

**II. BASIC OPERATION
(SHOOTING) Page 28 - 43**

A rectangular callout box with a double-line border and a drop shadow. A white circle is at the top left, with a line connecting it to the top-left corner of the box.

**IV. OTHER INFORMATION
Page 89 - 95**

- If you want to begin taking pictures with this new camera as soon as possible, read section I and II, "BASIC OPERATION (PREPARATION)" and "BASIC OPERATION (SHOOTING)." These sections introduce only the basic functions of this camera. More detailed information can be found in the section III and the section IV.

I . BASIC OPERATION (PREPARATION)

(1) ATTACHING THE CAMERA STRAP

13

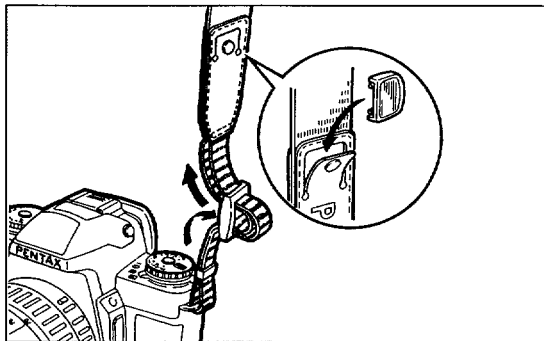

Fit the strap on the camera as illustrated.

- There is a pocket on the strap so you can store the finder cap, release socket cover, hot shoe cover or any other small accessory as illustrated.

(2) LOADING THE BATTERIES

1

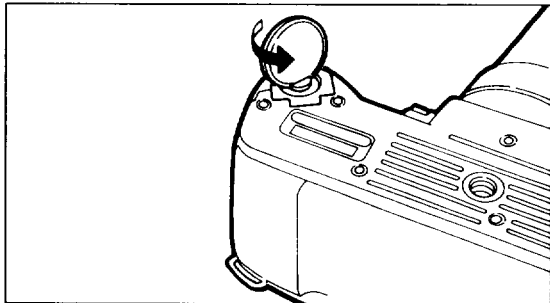

1. Open the battery chamber cover by using a coin, etc. as shown in the illustration.

2

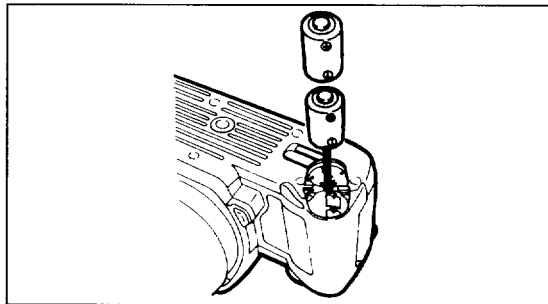

2. Load two 3V lithium batteries (**CR2**) or equivalent as shown in the illustration.

- Misuse of the battery can cause hazards such as leakage, overheating, explosions, etc. The battery should be inserted with the "+" and "-" sides facing correctly.

3

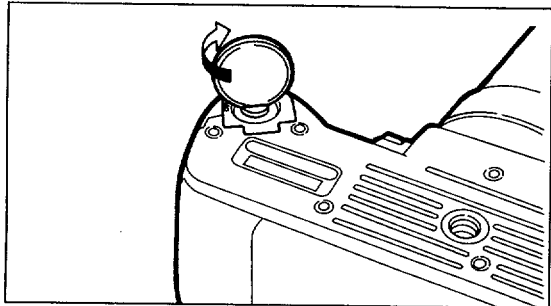

3. Turn the battery chamber cover screw in the direction of the arrow to lock it securely.

- When the battery is replaced, all camera settings remain unchanged except the audible PCV signal switching, red-eye reduction flash function and automatic flash function of the built-in flash.
- The optional "AA-Battery Pack F₆" is also available for this camera instead of using the lithium batteries.

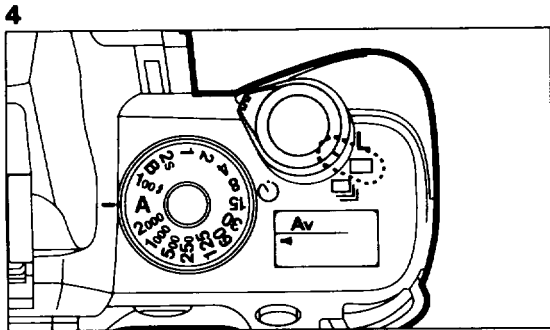

4. Set the drive mode switch to [] and check that the LCD panel shows the information as shown above.

- The LCD display as shown above is given as an example and may be different if a lens is attached.

Battery Life (Using 24-exposure film rolls)

General existing light photography	about 120 rolls
Flash photography (using flash 50% of the time)	about 20 rolls
Flash photography (using flash 100% of the time)	about 12 rolls
Bulb exposure time	about 8 hours

CR2 batteries were used under Pentax testing conditions. Actual battery life and performance may vary drastically depending on usage of Autofocus, Power zoom and external conditions such as temperature and freshness of the battery.

*

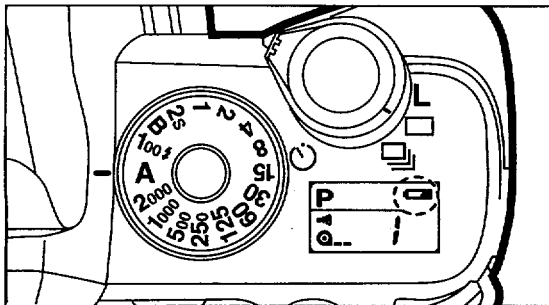
*** Low Battery Warning**

When the batteries are nearly exhausted, the battery symbol [] appears on the LCD panel to warn you. Replace the batteries as soon as possible. See page 14.

- When the low battery warning [] starts blinking, the shutter cannot be released and all indications in the viewfinder disappear.
- Replace the two batteries at the same time. Do not mix battery brands, type or old battery with a new one. It may cause explosion or overheating.

(3) ATTACHING THE LENS

1

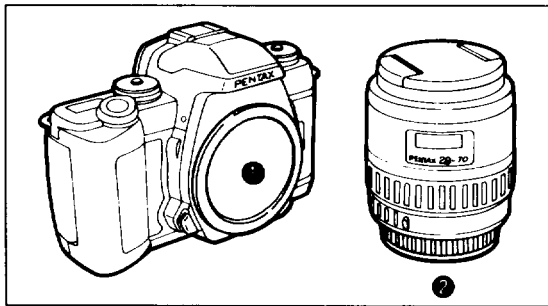

1. Remove the body mount cap ❶ and rear lens cap ❷ as shown in the illustration.

- The body mount cap is designed to protect the camera against scratches and dust at the factory. For storage, the optional accessory "Body Mount Cap K" is available.

2

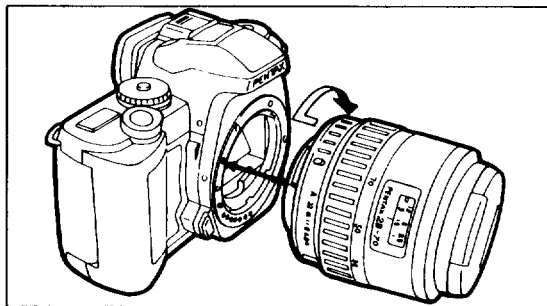

2. Align the red dots on the camera and lens mount, attach the lens to the camera body, and turn it fully to the right until you hear a click.

- Ensure that the camera's drive mode switch in the [L] position before attaching an FA zoom lens to prevent unexpected operation of the lens.

3

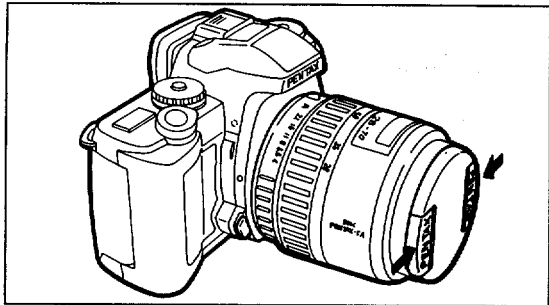

3. To remove the front lens cap, squeeze the tabs on both sides in the direction of the arrow.

- We assume no responsibility nor liability for damages resulting from the use of lenses made by other manufacturers.
- The camera body and lens mount incorporate lens information contacts and an AF coupler. Dirt, dust, or corrosion may cause damage to the electrical system. Clean the contacts with a soft, dry cloth.

*

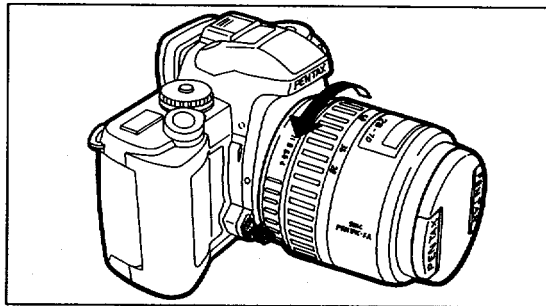

*** How to remove**

To remove the lens, turn it to the left while depressing the lens-lock-release button.

- To protect the contacts and AF coupler of the lens against damage after removal, be sure to set the lens down with the mount side facing upward.

(4) USING THE SHUTTER RELEASE BUTTON

The shutter release button has two positions. Depressing it down halfway (first position) turns on the exposure meter and autofocus system. Depressing it fully (second position) releases the shutter. When taking a picture, depress the shutter release button gently to prevent camera shake.

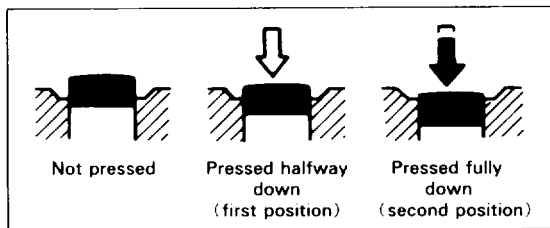

- To prevent camera shake, depress the shutter release button gently.
- Before loading a roll of film, slowly depress the shutter release button to learn where the first position is.
- The LCD indication stays on for about 10 seconds after the button is released from the halfway position. Depressing the shutter release button down halfway keeps the LCD indicator on.

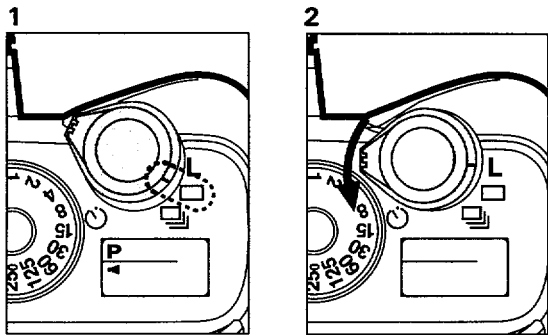

(5) TURNING ON THE POWER



1. The power is turned on when the drive mode switch is set to [P].
2. The power is turned off when the drive mode switch is set to [L].

- When not in use, ensure that the drive mode switch is set to [L].
- When the drive mode switch is set to [□], film is advanced one frame after each exposure, and the camera is always ready for the next shot.
- The Consecutive-Frame Mode [] and Self-Timer Mode [] are also available. See page 45 for more details.

(6) FILM LOADING

We suggest that you first operate the camera with no film loaded to become familiar with its operation.

Automatic film speed setting

This camera is designed to use DX-coded films with ISO rating from 25 to 5000.

- When DX-coded film is used, the correct film speed is automatically set for the camera. If you use a non-DX coded film, you can set the film speed manually. See page 75.
- Before loading film for the first time after purchase, open the back cover and remove the protective card. **DO NOT TOUCH THE SHUTTER CURTAINS.**

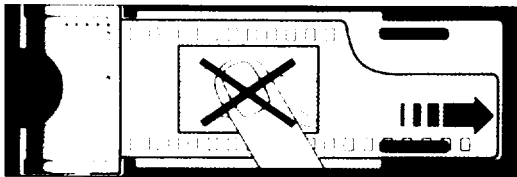

1

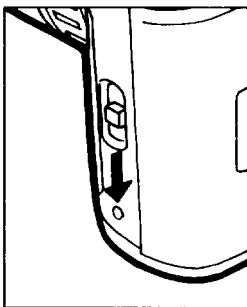

2

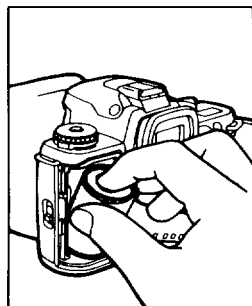

1. To open the back cover, slide the back cover release lever in the direction of the arrow.
 2. Place the film cartridge in the film chamber as shown in the illustration.
- Always load and unload a film in the shade or by using your body to shade the camera.

3

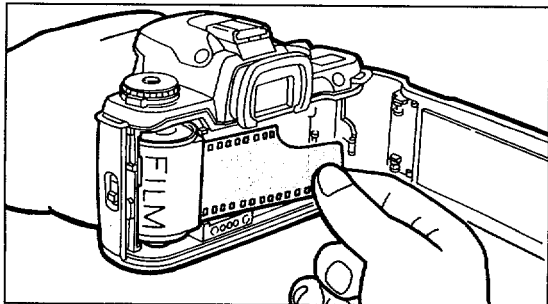

3. As shown in the illustration, pull the film leader out only far enough to reach the take-up spool.

THE SHUTTER CURTAINS ARE FINE-PRECISION MATERIAL. DO NOT TOUCH THEM WITH YOUR FINGERS OR ANY OTHER OBJECT WHILE LOADING FILM.

- If you have pulled out too much film, push it back into the cartridge to reduce the slack.
- The DX information pins in the film chamber are used to read film speed. Keep them clean and free from scratches. To remove smudges, wipe them gently with a soft, dry cloth.

4

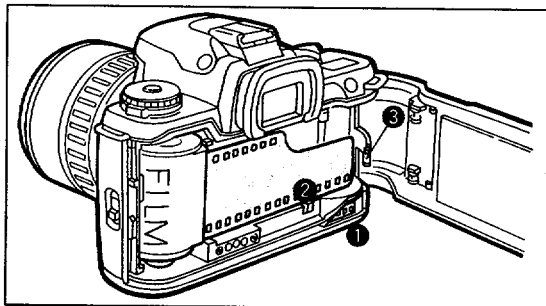

4. Align the film leader with the film leader end mark ❶ as shown.

- Make sure that the film perforations properly engage on the sprocket teeth ❷.
- Make sure that the film leader is positioned under the film retainer ❸ as shown in the illustration.

Film loaded with slack No!

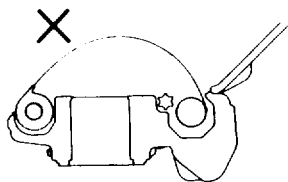

Film loaded flat Yes!

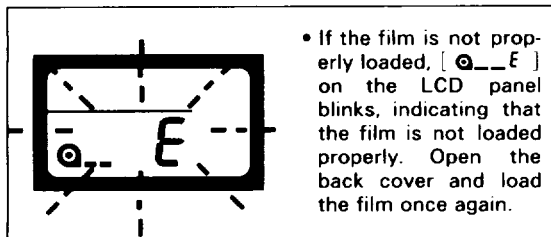
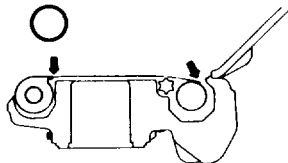

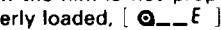

- If the film is not properly loaded, [] on the LCD panel blinks, indicating that the film is not loaded properly. Open the back cover and load the film once again.

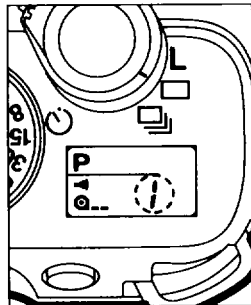
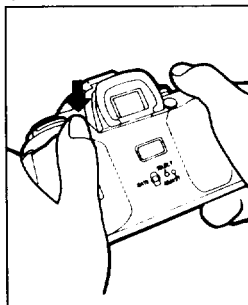
5



5. Close the back cover and set the drive mode switch to a position other than [L]. The film automatically advances to the first frame.

- Check that [] and [] are displayed on the LCD panel.
- The film counter indication advances one each time the shutter is released.

(7) UNLOADING FILM

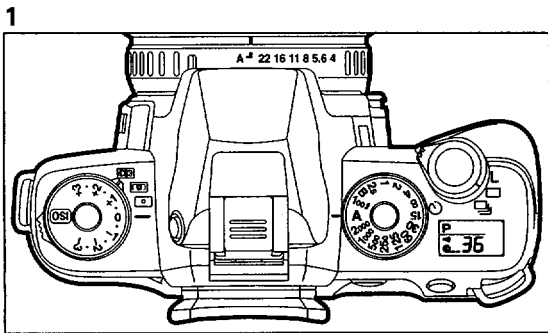

1. After the last frame of the roll is exposed, the camera will rewind the film automatically.

- During rewinding, [—] blinks on the LCD panel, indicating that the film is being rewound, the exposure counter counts frame numbers in reverse.
- Never open the back cover until the whole film roll is completely rewound.
- When removing the film from the camera, protect it from exposure to direct sun light.

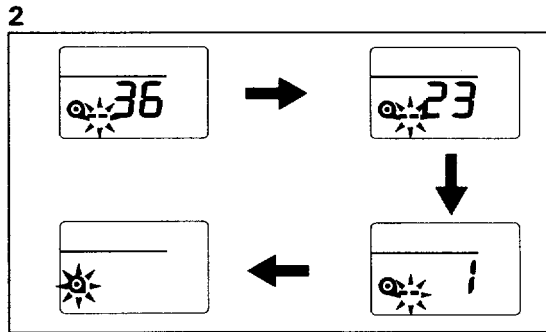

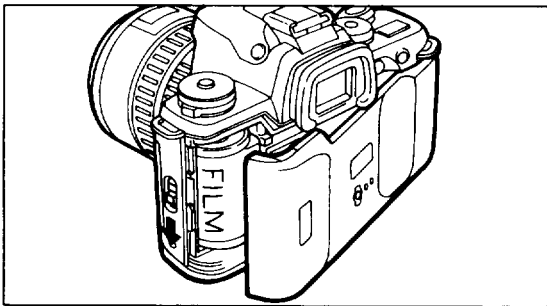

2. When the film is fully rewound, only [☉] blinks on the LCD panel.

3



3. Open the back cover and remove the film.

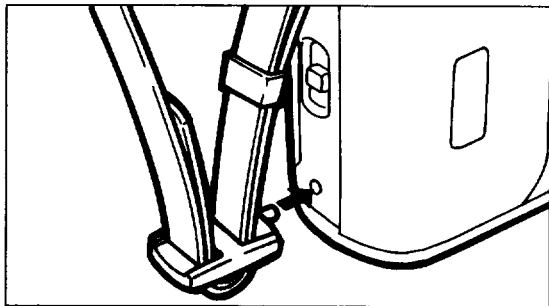

- A roll of 24-exposure film takes about 13 seconds to rewind.
- Before opening the back cover, check that [] is blinking.
- When the camera is not in use, set the drive mode switch to the [] position.
- The shutter may be released a frame or more after the specified number of frames have been used as indicated by the number of frames on the film cartridge. However, those extra frames may be lost in the processing. When you take important pictures, rewind the film when the film reaches the number of frames indicated on the film cartridge.

*



* Rewinding a Roll of Film in Mid-Roll

If you wish to unload the film before exposing all the frames, use this function.

- Set the drive mode switch to a position other than the [] position, and then depress the mid-roll rewind button by using the protruding part of the strap clamp.
- Before opening the back cover, check that [] is blinking.

(8) ADJUSTING THE VIEWFINDER DIOPTER

27

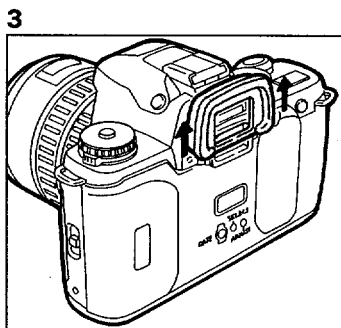
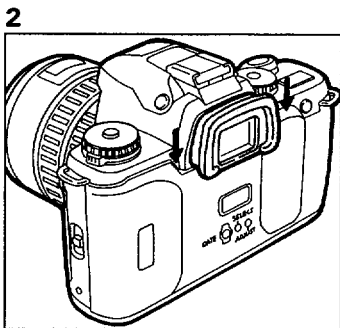
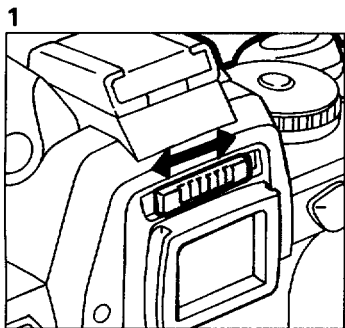

1. Aim the camera at a bright subject. While looking through the viewfinder, move the diopter adjustment lever to the left or right until the autofocus frame [] appears in the sharpest focus.
2. To attach the Eyecup F₆, slide it down the grooves on both sides of the viewfinder.
3. To detach the Eyecup F₆, push it up in the direction of the arrow.

- The diopter adjustment range is +1.5D to -2.5D (diopters).

II . BASIC OPERATION (SHOOTING)

(1) USING THE PROGRAMMED AE MODE

Purpose

For easy picture taking, use this mode. In the Programmed AE mode, the camera automatically selects the best combination of aperture and shutter speed setting allowing you to take pictures by simply depressing the shutter release button.

- See page 56, 58 and 60 for other available exposure modes.

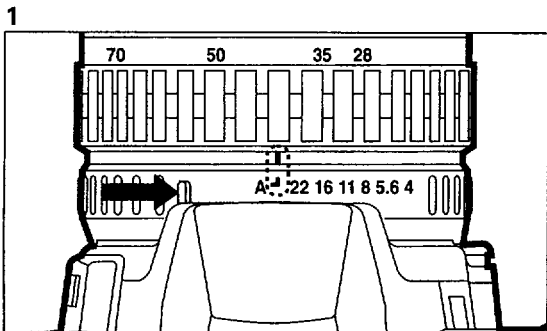

How to set

1. Turn the lens aperture ring to the [A] position as shown in the illustration.

- To move the lens aperture ring to the [A] position, turn the aperture ring while holding down the aperture-A lock button on the lens. The lens aperture ring can be released from the [A] position in the same manner.

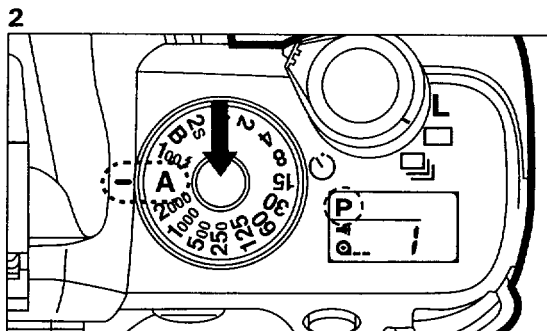

2. Turn the shutter dial to [A] while holding down the shutter dial lock button. The shutter dial can be released from [A] in the same manner.

- [P] appears on the LCD panel to indicate that the Programmed AE Mode is set.

(2) USING THE MULTI (6)-SEGMENT METERING MODE

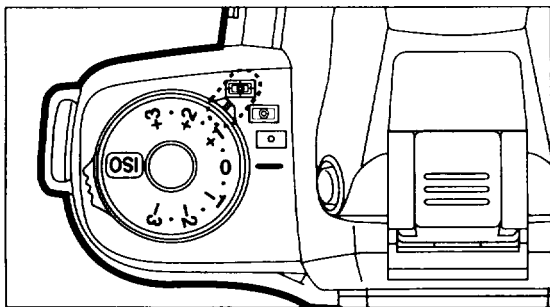

In the multi(6)-segment metering mode, the metering system automatically measures light in six different zones, enabling proper exposure value in a wide variety of normal and adverse lighting conditions, such as a backlit condition.

1. Set the metering mode switch to [].
- When a lens other than an A, F or FA lens is attached, use either center-weighted metering or spot metering. The multi-segment metering mode cannot be set. See page 68 for selecting the metering mode.

MULTI (6)-SEGMENT METERING

This camera incorporates a high-precision six-segment TTL metering system. Light values are measured in six segments within the image field, enabling an optional exposure to be made under a variety of lighting conditions. With conventional averaged metering systems, underexposure of the subject results from the brightness of the background affecting the overall metering. With multi(6)-segment metering, the camera records the brightness in six zones within the image field and uses these measurements to choose an exposure that will properly expose the subject. The multi(6)-segment metering system also calculates exposure values for a scene to automatically compensate for high-contrast and other difficult lighting conditions. Even a beginner can achieve results with ease.

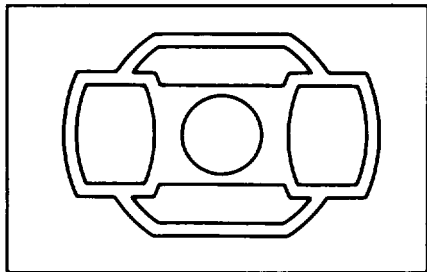

(3) USING ZOOM LENSES



Telephoto



Wide angle

Using the zoom function makes the subject appear larger (telephoto) or smaller (wide angle) in the viewfinder. Turn the zoom ring to the desired position and depress the shutter release button to take a picture.

- The smaller the number shown in the zoom scale window, the wider the angle. Conversely, the larger the number, the more magnified the image appears.

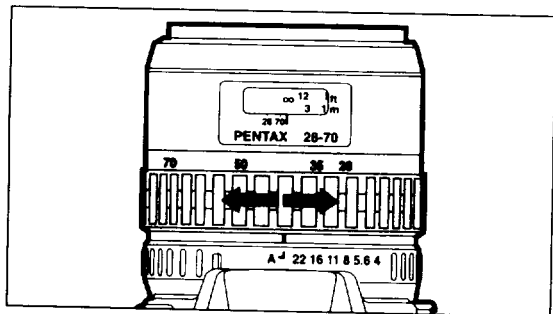

Turning the zoom ring to the right makes the subject appear larger (telephoto) and turning it to the left makes the subject appear smaller (wide angle).

*

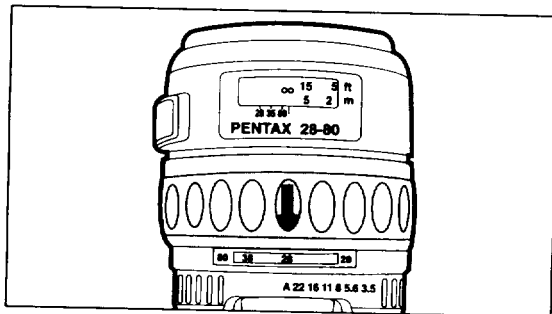

Using the manual zoom function with an FA zoom lens attached

Pull the power zoom ring toward the camera body until the words [POWER ZOOM] are hidden.

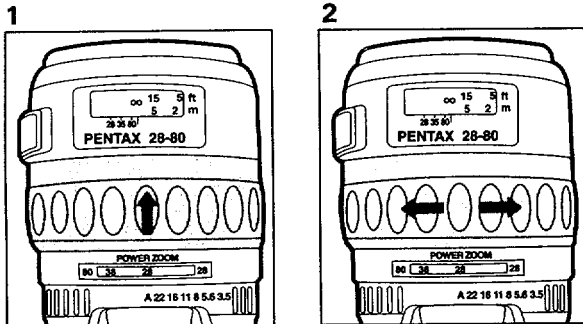

Using the Power Zoom Function

1. Push the power zoom ring forward until the words [POWER ZOOM] appear beneath the power zoom ring.
2. Turning the power zoom ring to the right brings the subject closer (telephoto) and turning it to the left makes the subject smaller (wide angle). To stop zooming, release the power zoom ring.

- If a power zoom lens is attached, three zooming speeds are available. Turning the power zoom ring fully to the right or left, zooms the lens quickly. Turning it slightly gives you slow operation. At an intermediate position, the lens zooms at medium speed.
- Zooming the lens with the power zoom function automatically focuses the lens on the subject. However, for final focusing, depress the shutter release button halfway down to focus the subject.
- When the drive mode switch is set to [L] while a Pentax-FA zoom lens is in use, the lens automatically retracts to its shortest physical length.

(4) HOLDING THE CAMERA

Camera held horizontally

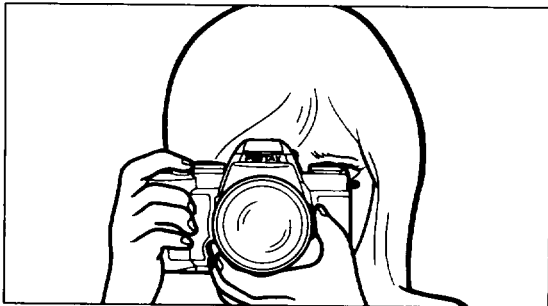

For best results, be sure to hold the camera correctly as shown in the illustrations.

Hold the camera firmly, with your left hand supporting the camera and lens as shown in the illustrations.

While taking a picture, hold your breath and gently depress the shutter release button. (Sudden force on the shutter release button will cause camera shake, making the picture blurred.)

Camera held vertically

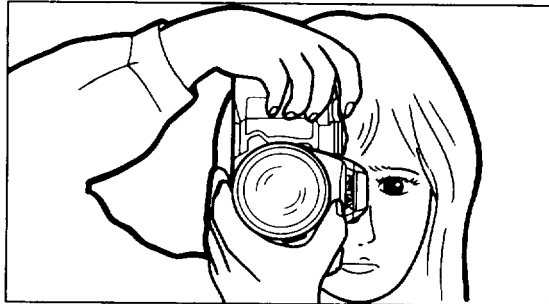

- To reduce camera shake, support your body or the camera on a solid object - a table, tree, or a wall for instance.
- When using an ultra-telephoto lens, a tripod that is heavier than the total weight of the camera and lens is recommended to avoid camera shake.

(5) SELECTING THE AUTOFOCUS MODE

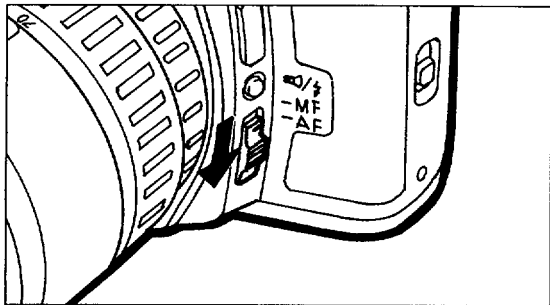

Set the focus mode switch to [AF].

- For autofocus operation, set the focus mode switch to [AF].
When you depress the shutter release button halfway down, the lens automatically focuses.
- See page 47 for manual focusing.

(6) TAKING A PICTURE

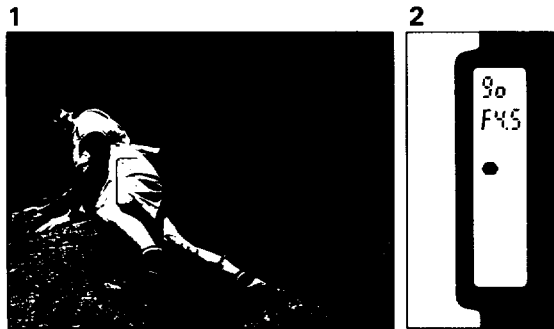



Set the focus mode switch to [AF].

1. Focus on the subject with the 3-point AF frame [] indicating in red in the photograph. When the shutter release button is depressed halfway down, the lens automatically focuses.
2. When the subject is in focus, the focus indicator [] lights up and an audible PCV beeping signal is emitted.

- As this camera incorporates 3-point autofocus system, the subject will be focused properly even if the subject is slightly off the center of the AF frame.
- Select the Spot AF Mode to focus on a particular spot in the frame. See page 65.
- When the shutter release button is depressed halfway down, the shutter speed and aperture setting are displayed in the viewfinder.
- When [] blinks in the viewfinder and on the LCD panel, the use of the built-in flash is recommended. For more details on the built-in flash, see page 38.
- The audible PCV signal can be turned off. See details on page 70.
- During autofocus operation, the focusing ring should not be obstructed with your fingers, hands, or any other objects.

The focus indicator [] blinks when the camera is not able to obtain proper focus for one of the following reasons.

1. The subject is too close. Adjust the camera-to-subject distance.
2. The subject is difficult to autofocus. See "HARD-TO-AUTOFOCUS" on page 50.

3. To release the shutter, gently depress the shutter release button fully.
- The shutter cannot be released if the subject is out of focus.
 - Depress the shutter release button halfway down. While [] is on, the camera-to-subject distance is fixed (focus lock). To refocus on another subject, lift your finger off the shutter release button.
 - When the drive mode switch is set to the consecutive mode [], the lens focuses each time you release the shutter.
 - When using the SMC Pentax-F Soft 85mm f/2.8 lens, set the aperture between f/2.8 and f/4.5. See page 51 for details.

Predictive Autofocus Mode

When the camera senses subject movement during the autofocus operation, the camera will automatically switch the focus mode to the predictive autofocus mode to measure the speed of a moving subject, and predict where it will be at the moment of shutter release to maintain sharp focus on the subject.

- If the subject is moving too fast, the shutter may not be released.

(7) BASIC OPERATION FOR THE BUILT-IN RETRACTABLE TTL FLASH (RTF)

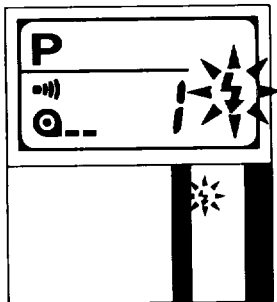
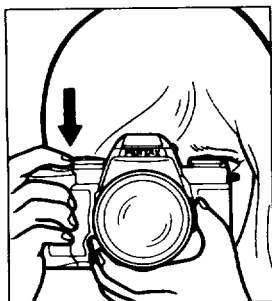
**The Flash-Recommended Indicator**

If the built-in flash is recommended, the flash-recommended indicator [⚡] starts blinking in the viewfinder and on the LCD panel when the shutter release button is depressed halfway down.

- In the Programmed AE Mode and the Aperture-Priority AE Mode, the flash-recommended indicator [⚡] blinks when you attempt to photograph a subject in low light, or in a backlit situation. In the Shutter-Priority AE Mode and the Metered Manual Mode, the flash-recommended indicator blinks only when attempting to photograph a subject in a backlit situation.

1

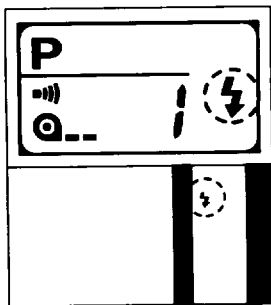
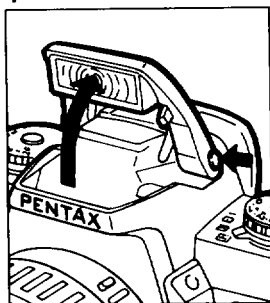
**Using the built-in flash**

If [A] is displayed on the LCD panel, it indicates that the automatic flash function is set. Delete it from the LCD panel. See page 43 for more details.

1. Push the flash pop-up button to activate the flash.
 - The flash unit starts charging automatically. When it is fully charged, [⚡] appears on the LCD panel. When the shutter release button is depressed halfway down, [⚡] also appears in the viewfinder.
 - When the built-in flash is used, using the lens hood is not recommended as it may obstruct the path of the light coming from flash, causing vignetting in the picture corners.

2

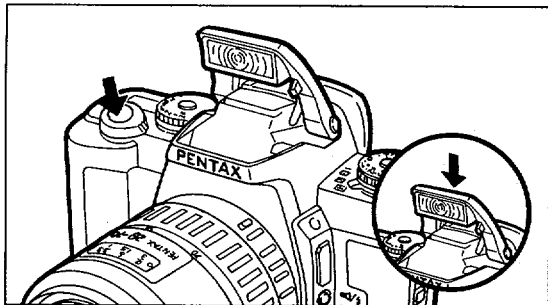

2. Depress the shutter release button fully, and the flash unit discharges. After using the flash, retract the built-in flash by pressing it down into the camera body.

- If the Built-In flash is used continuously, the battery may become warm, but it does not mean the battery is faulty; it is one of the battery's characteristics.
- With the Built-in flash popped-up, an External Flash cannot be attached to the hot shoe. If you would like to use an external flash together with the Built-in flash, see the flash connections on page 76.
- The shutter cannot be released until the flash is fully charged.

Flash effective range for Programmed TTL Auto Flash with ISO 100 (400) film used

Maximum Lens Aperture	Effective Range
f/1.4	approx. 0.8 - 3.9m (0.8- 5.6m) 2.6 - 12.8ft (2.6-18.4ft)
f/2	approx. 0.8 - 3.3m (0.8- 4.8m) 2.6 - 10.8ft (2.6-15.7ft)
f/2.8	approx. 0.7 - 2.8m (0.7- 4.0m) 2.3 - 9.2ft (2.3-13.1ft)
f/3.5, f/4.7	approx. 0.7 - 2.4m (0.7- 4.0m) 2.3 - 7.9ft (2.3-13.1ft)
f/5.6	approx. 0.7 - 2.0m (0.7- 4.0m) 2.3 - 6.6ft (2.3-13.1ft)

The effective range of the flash depends on the maximum aperture of the lens in use. A lens with a maximum aperture of f/1.4 is marked as 1:1.4 on its barrel.

- This effective range table is only applicable when the exposure mode is set at the Programmed AE Mode. When any other exposure mode is used, see page 72.
- The minimum effective range is always 0.7m (2.6ft) even if a lens with a maximum aperture f/2.8 or smaller is in use. When a subject is shot at a distance closer than 0.7m (2.6ft), the correct exposure cannot be obtained, and you will see vignetting in the picture corners.

Inappropriate lens warning when the built-in flash is used

When using an inappropriate F- or FA- lenses, [] will blink in the viewfinder and on the LCD panel when the shutter release button is depressed halfway down. For more details on **COMPATIBILITY OF F AND FA LENSES WITH THE BUILT-IN FLASH**, see page 73.

- Taking a picture while this warning is displayed may cause vignetting in the picture corners or semi-circular vignetting at the bottom of the picture.
- Keep in mind that when lenses other than an F or FA are used, this warning will not appear.

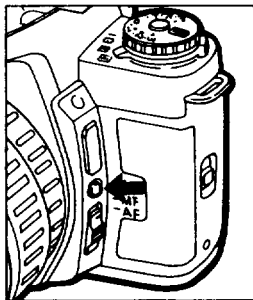

Depressing the multi-function button with the built-in flash popped up

At each press of the multi-function button, the flash mode on the LCD panel switches as shown in the chart.

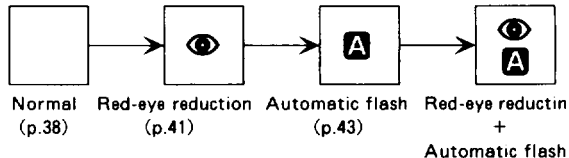

When the built-in flash is retracted, depressing the multi function button switches the audible PCV signal ON and OFF.

1

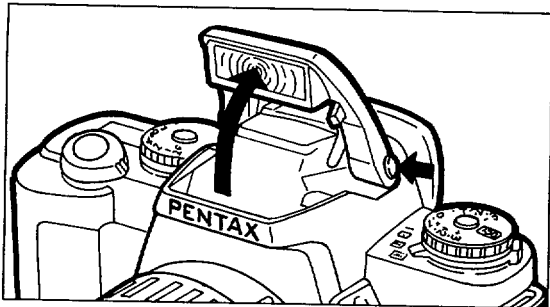

Red-eye Reduction Flash Function

This camera includes a red-eye reduction flash function, which reduces the red-eye phenomenon by utilizing a preflash. In this mode, the preflash is discharged just before the shutter is released which reduces the diameter of the pupil of the eye. Then the main flash is discharged while the pupils are smaller, which in turn reduce the red-eye effect.

2

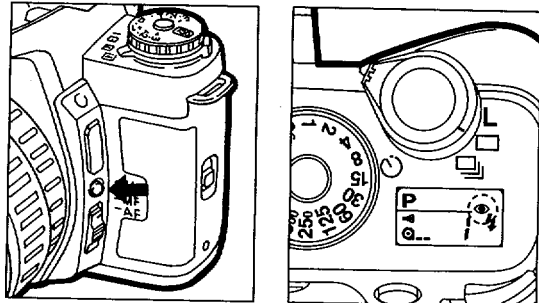

How to set

1. Push the flash pop-up button to activate the flash.
 2. Depress the multi function button until [👁] appears on the LCD panel.
- To set the red-eye reduction flash function, depress the multi-function button only when the built-in flash is in the popped up position. If the multi-function button is depressed with the built-in flash is in the retracted position, the PCV signal mode will be switched.

How to cancel

With the built-in flash in its popped up position, depress the multi-function button until [👁] disappears from the LCD panel.

- When the AF500FTZ is attached and the slave flash function is in use, the red-eye reduction flash function cannot be used as the slave flash is discharged when the preflash of the built-in flash is discharged.
- When only a dedicated flash is in use and is discharged, the red-eye reduction display on the LCD panel is disregarded.

About Red-eye Phenomenon

Shooting portraits with flash in a dark environment often causes a subject's eyes to turn out reddish in the print. This phenomenon, commonly known as "Red-Eye", is caused by the reflection of the electric flash in the retina of your subjects eye. It can be reduced by taking the photo in a brighter light condition or by shooting with a wider angle lens at a closer distance, or by employing the red-eye reduction flash feature. When using a Pentax dedicated flash unit off the camera, it may also help to position the flash as far away from the camera as possible.

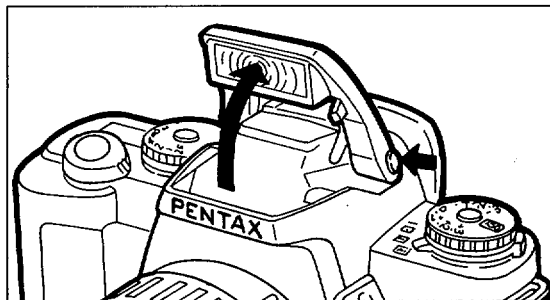

AUTOMATIC FLASH FUNCTION

This is a convenient flash mode that the flash discharges only when it is necessary even if the flash is in the popped-up position.

The Automatic Flash Function varies depending on the selection of the camera's metering mode and the exposure mode as follows.

Exposure Mode	Metering Mode		
	Multi-segment	Center-weighted	Spot
Programed AE	Automatic discharge in low light and backlit situations	Automatic discharge in low light situation	Automatic discharge in low light situation
Other Exposure Modes	Forced emission	Forced emission	Forced emission

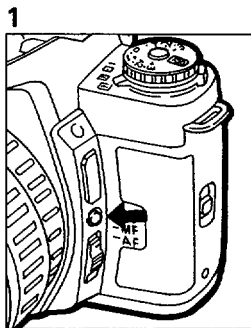

How to set

1. Push the flash pop-up button to activate the flash.
2. Depress the multi-function button until [A] appears on the LCD panel.

- In the Programed AE Mode or the Aperture-Priority AE Mode, the flash discharges when the subject is in a low light or backlit situation.
- In the Shutter-Priority AE Mode, the flash discharges only when the subject is in a backlit situation.
- Depress the multi-function button with the built-in flash popped up position. If the button is depressed with the built-in flash retracted position, the PCV mode will be switched.

How to cancel

With the built-in flash popped up, depress the multi-function button until [A] disappears from the LCD panel.

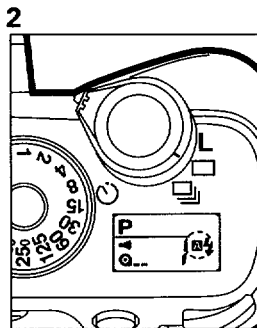



III. ADVANCED OPERATIONS

(1) SELECTING A DRIVE MODE

This camera has a total of three drive modes as shown.

Types of Drive Modes

Single-Frame Mode

[] : One picture is taken each time the shutter release button is depressed.

Consecutive-Frame Mode

[] : Pictures can be taken consecutively while holding down the shutter release button. See page 45.

Self-Timer Mode

[] : A picture will be taken with a 12-second-delay. See page 45.

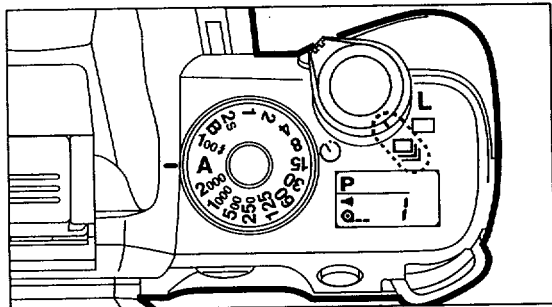

1) Consecutive-Frame Mode

Consecutive pictures can be taken by holding down the shutter release button.

How to set

Set the drive mode switch to [].

- The camera focuses on the subject frame by frame in this mode.
- The shutter cannot be released while the built-in flash is being charged.

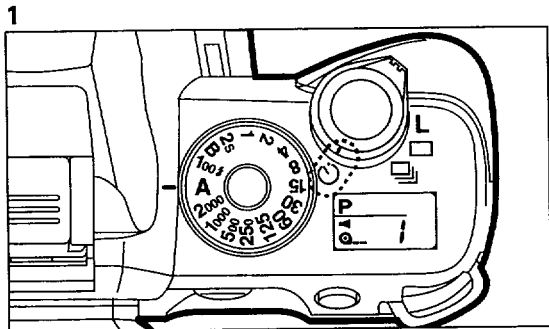

2) Self-Timer Mode

The self-timer mode delays the shutter release, and is useful for taking group shots that include the photographer. The shutter will be released about 12 seconds after the shutter release is depressed.

How to set

1. Set the drive mode switch to [].

2

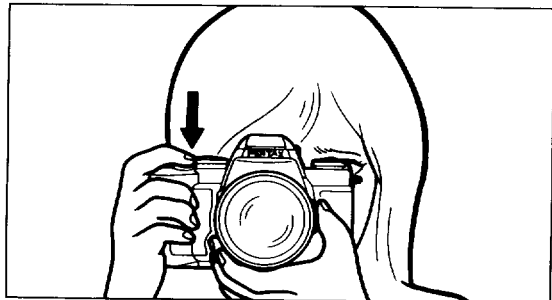

2. Focus on the subject first using the autofocus frame and by depressing the shutter release button halfway down. Then depress the shutter release button fully.

- The shutter will be released about 12 seconds later.
- When the self-timer is in operation, the audible PCV signal is heard and the rate increases for the last two seconds.

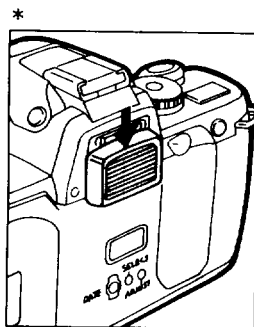
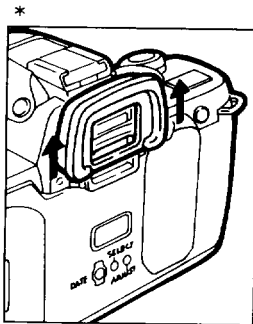

How to cancel

To cancel the self-timer operation after it has been activated, move the drive mode switch to a position other than [L].

- * Underexposure may occur if light enters the viewfinder during self-timer operation. If you intend to move away from the viewfinder, attach the supplied finder cap as shown in the illustration.
- * When using accessories such as the finder cap, remove the Eyecup F₆. The Eyecup F₆ comes from the factory fitted to the camera's viewfinder accessory grooves.

(2) MANUAL FOCUSING

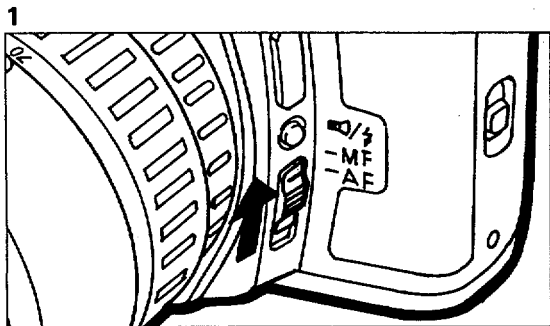

Using a manual-focus lens

When mounting a non-autofocus lens with a maximum aperture of $f/5.6$ or larger ($f/1.2$ to $f/5.6$), you can use the manual focus mode to focus the lens with the aid of the in-focus indicator [\square] in the viewfinder.

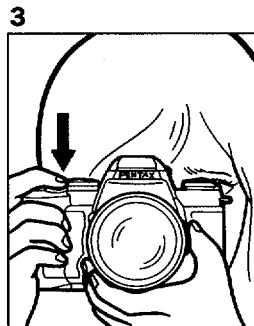
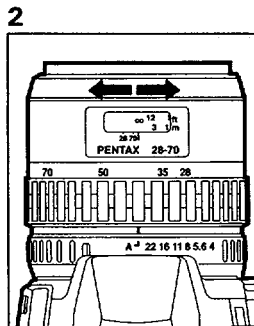

How to focus

1. Set the focus mode switch to [MF].
2. While looking through the viewfinder, turn the focusing ring to the right or left while holding the shutter release button halfway down.
3. When the subject comes into focus, the in-focus indicator [\square] lights up in the viewfinder. Depress the shutter release button fully to take the photograph.

- When the subject comes into focus, the focus indicator [○] lights up in the viewfinder and an audible PCV signal is heard. The audible PCV signal can be canceled. See page 70.
- If an old type screw-mount lens is used with an optional Mount Adapter K, the in-focus indicator in the viewfinder cannot be used.

When the autofocus mode or the in-focus indicator is unsuitable for focusing

When the autofocus function or the viewfinder's in-focus indicator [○] cannot be used for focus confirmation for the following reasons, focus on the subject in the manual focus mode with the aid of the matte field in the viewfinder as you would with a non-AF SLR camera.

- a) The in-focus indicator [○] blinks because the subject is difficult to autofocus.
- b) The maximum aperture of the lens in use is smaller than $f/5.6$.
- c) A bellows 100mm $f/4$, Shift 28mm $f/3.5$ (shifted), or Reflex lens is in use.
- d) An old type screw-mount lens fitted with an optional "Mount Adapter K".

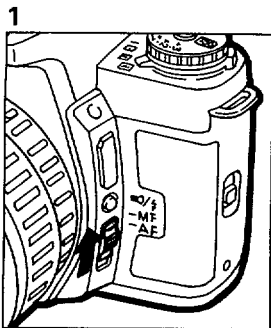

How to focus on the subject

1. Set the focus mode switch to [MF].
2. While looking through the viewfinder, turn the focusing ring to the right or left until the image in the viewfinder is clearest.

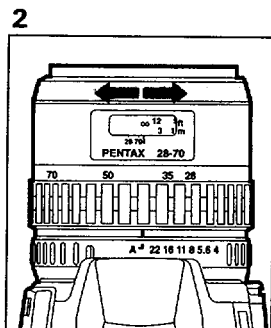

Using the snap-in focus function

When the subject comes to the point where the lens was prefocused, the shutter is automatically released.

How to use

1. Use a non-autofocus lens.
2. Set the focus mode switch to [AF].
3. Focus at the point where you wish to capture the subject.
4. Using the optional "Cable Switch F", keep the trigger release button depressed so that the autofocus and metering systems stay active.
5. The camera releases the shutter automatically when the subject comes into focus at the point selected.

HARD-TO-AUTOFOCUS SUBJECTS

The autofocus system is highly precise, but not perfect. Depending on the brightness, contrast, shape, and size of your subject, the autofocus system may not operate. In such a case, use the focus-lock technique (see page 66.) on another subject that is the same distance away, or set the focus mode switch to **[MF]** and use the manual focus mode to focus the lens on the subject with the aid of the matte field in the viewfinder (see page 47).

Subjects which may fool the autofocus system include:

- a) Extremely low-contrast subjects such as a white wall in the autofocus frame **[C]**.
- b) Subjects which don't reflect much light in the autofocus frame **[C]**.
- c) Subjects which are moving too fast.
- d) Multiple subjects in the foreground and background of the autofocus frame **[C]**.
- e) Subjects positioned against reflected light or strong backlight or with extremely bright backgrounds.

Notes on Accessories

The following conditions do not allow autofocusing or manual focusing with the in-focus indicator in the viewfinder. Use the manual focus mode to focus on the subject with the aid of the matte field surrounding the autofocus frame.

- a) When using special effect filters or "Magic Image Attachment" or "Stereo Adapter".
- b) When using Extension Tubes or an Auto Bellows for close-up photography.

Note on the SMC Pentax F SOFT 85mm f/2.8 lens

When shooting at a distance closer than approx. 1.5m (4.9ft), set the lens to a manual f-stop setting between f/2.8 and f/4.5. A smaller aperture (f/5.6 to f/32) may cause the autofocus system and the viewfinder's in-focus indicator to malfunction. To remedy this problem, temporarily set the lens to f/4.5. After focusing on the subject, lock focus, and set the lens to the required f-stop.

Using A Polarizing Filter

When using an ordinary polarizing filter; a half mirror incorporated into the autofocus system reduces the effectiveness of the autofocus function when used in combination with an ordinary polarizing filter. Use a **CIRCULAR POLARIZING FILTER** for proper autofocus operation.

(3) TAKING PANORAMIC FORMAT PICTURE

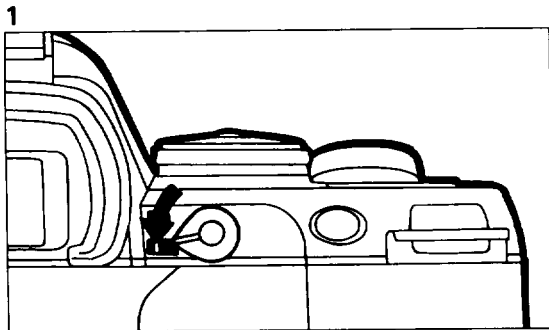

You can switch between the panoramic format and standard format picture taking mode in the middle of the roll by moving the panorama lever. The panoramic format picture allows horizontally positioned dynamic pictures to be taken (the panoramic format is approximately 13x36mm on the film).

1. Turn the panorama lever to [] to select the panoramic format mode.
2. Compose the scene within the panoramic format frame in the viewfinder.

2



- When the panorama lever is switched to panorama, the viewfinder switches to the horizontal panoramic format frame.
- Ensure that the panorama lever is turned fully to the position you selected.
- What appears on the extreme edges of the panoramic frame may be cut off in the development process. Compose your picture with a margin of safety.

NOTES ON THE DEVELOPMENT OF PANORAMIC FORMAT PICTURE

- With panoramic format pictures, only the middle area of the frame is exposed. The number of exposures available in the panoramic format is equivalent to that of the standard photo size.



- When developing the film, if you have taken only panoramic format pictures on the entire roll of film, tell the clerk at the processing lab to develop the film with only the panoramic format. If there are both panoramic and standard format pictures on the film, ask the clerk to develop the film with both standard and panoramic format.
- The development of panoramic format pictures is a more time-consuming and expensive process than that of standard pictures. Please consult the processing lab for more details.
- Panorama format processing facilities differ depending on the area and requirement. Your local film processor or camera dealers will advise you on all options available to you.
- When the panoramic format pictures are printed with a standard size format, the black cropped areas will appear at the top and bottom of the picture.

(4) SELECTING AN EXPOSURE MODE

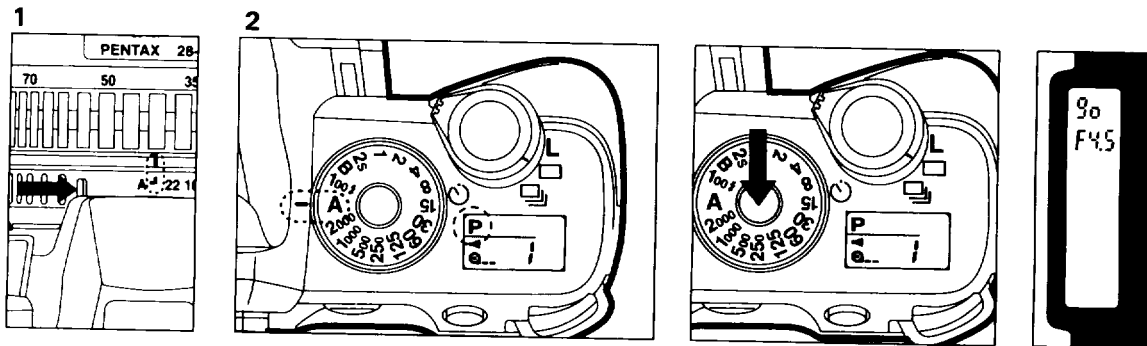

Using the Programmed AE Mode

Purpose

The camera automatically selects the optimum combination of shutter speed and aperture setting, making it easy to take a good photograph by just depressing the shutter release button.

How to set

1. Set the lens aperture ring to [A].
2. Set the shutter dial to [A].

- Turn the lens aperture ring while holding down the aperture-A lock button.
- Turn the shutter dial to [A] while holding down the shutter dial lock button. The shutter dial can be released from [A] to another position in the same manner as above.
- When the shutter release button is depressed halfway, the shutter speed and aperture setting will be displayed in the viewfinder.

*

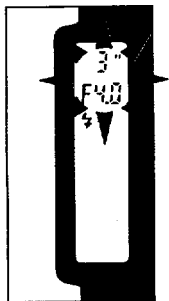

*** Exposure Warning**

If the subject is too bright or too dark, the shutter speed and aperture setting in the viewfinder will blink. If the subject is too bright, select a darker subject. Use a flash if the subject is too dark.

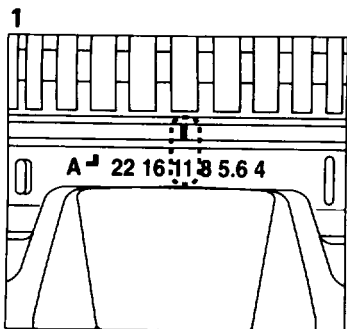

Using the Aperture-Priority AE Mode

Purpose

When the desired aperture is selected, an appropriate shutter speed is automatically set by the camera for a proper exposure. This mode is ideal for shooting landscapes with increased depth of field, or a portrait against a blurred background. For details on the effect of the aperture setting, see page 86.

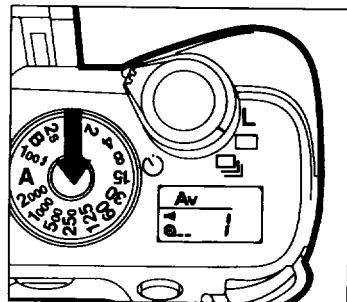
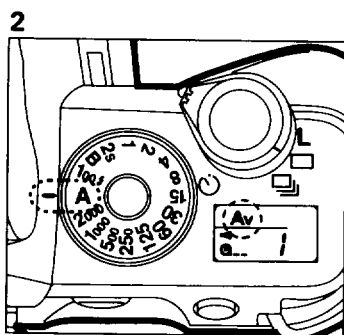

How to set

1. Set the lens aperture ring to an f-stop other than [A].
 2. Set the shutter dial to [A].
- Set the shutter dial to [A] while holding down the shutter dial lock button. [Av] appears on the LCD panel to indicate that the Aperture-Priority AE Mode is set.
 - The shutter dial can be released from [A] in the same manner as mentioned above.

3

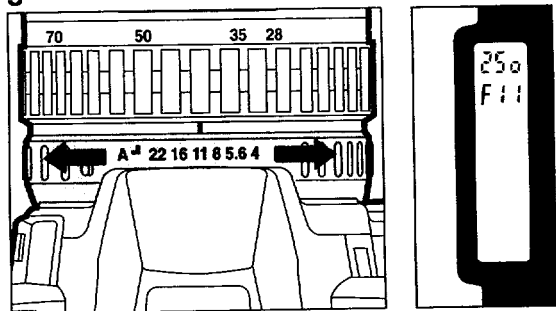

3. Set the desired f-stop

- When an F or FA lens is used, an approximate aperture indication will appear in the viewfinder when the shutter release button is depressed halfway. When lenses other than an F or FA series are used, no approximate aperture indication will appear in the viewfinder.
- When lenses other than an FA and F series are used, use either the center-weighted metering or the spot metering. The multi-segment metering mode cannot be used.
- When the Pentax A50mm f/1.2 lens is in use with the lens aperture ring set at a position other than the [A] position, the center-weighted metering mode will be set instead of the multi-metering mode. As the exposure will come out approx.1 stop overexposed, set

*

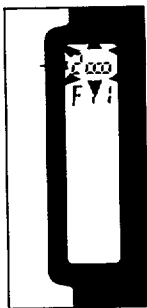

the lens aperture ring to [A] or adjust the exposure deliberately approx. 1 stop under.

* Exposure Warning

If the subject is too bright or too dark, the selected shutter speed will blink in the viewfinder and on the LCD panel as a warning as shown. When the subject is too bright, choose a smaller aperture, if available; when it is too dark, choose a large aperture, if available. When the shutter speed indication stops blinking, you can take the picture. If both shutter and aperture blink, it means that the exposure is out of metering range, unable to obtain a correct exposure even if the aperture is adjusted. Select a darker subject if it is too bright, or use a flash if it is too dark.

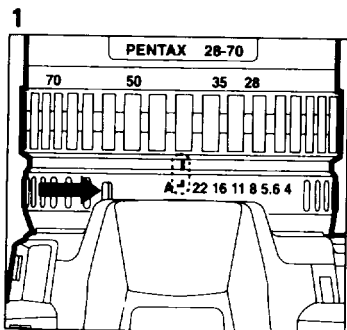

Using the Shutter-Priority AE Mode

Purpose

When the desired shutter speed is selected, the appropriate aperture is automatically set by the camera for a proper exposure according to the brightness of the subject. This mode is suitable for freezing the action with a fast shutter speed or capturing a flowing dynamic image with a slow shutter speed. For details on the effect of the shutter speed, see page 85.

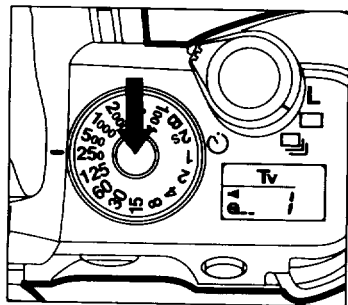
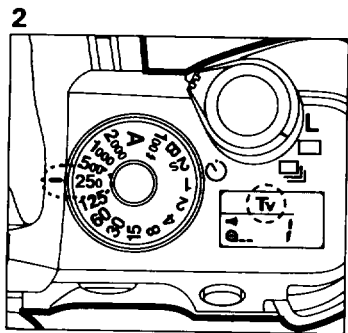

How to set

1. Set the lens aperture ring to [A].
 2. Set the shutter dial to a shutter speed other than [A].
- While holding down the shutter dial lock button, turn the shutter dial to the desired shutter speed. [Tv] appears on the LCD panel to indicate that the Shutter-Priority AE Mode is selected.

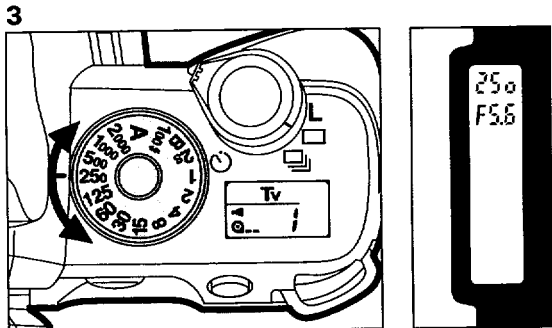

3. Set the shutter dial to the desired shutter speed.

- When the shutter release button is depressed halfway down, the shutter speed and the aperture value will be displayed in the viewfinder.
- In the flash photography, when you use the flash sync shutter speed of $1/100$ second or a non-dedicated external flash unit, set the shutter dial to the [100 $\frac{1}{2}$] ($1/100$ of second) position.

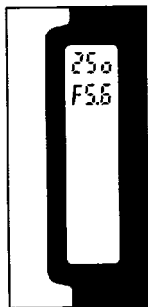

*** Exposure Warning**

If the subject is too bright or too dark, the shutter speed and aperture setting in the viewfinder blink. When the subject is too bright, choose a faster shutter speed. If it is too dark, choose a slower shutter speed. When the shutter speed indication stops blinking, you can take the picture. If both selected shutter speed and aperture blink, it means that the exposure is out of metering range, unable to obtain a correct exposure even if the shutter speed is adjusted. Select a darker subject if the subject is too bright. Use a flash if it is too dark.

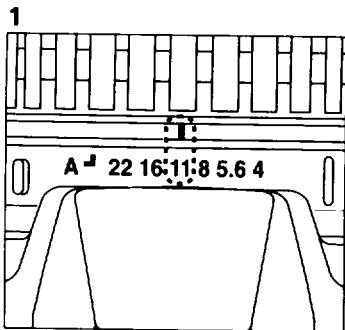

Using the Metered Manual Mode

Purpose

The Metered Manual mode is a convenient exposure mode for taking pictures using the same shutter speed and aperture setting combination, or taking creatively under or overexposed photographs.

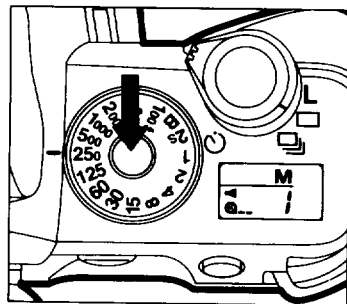
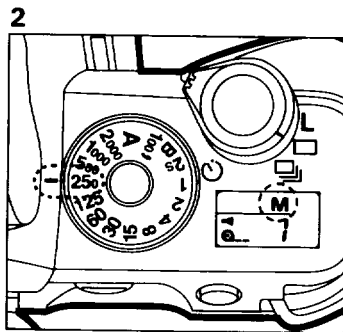

How to set

1. Set the lens aperture ring to the desired f-stop setting.
 2. Set the shutter dial to the desired shutter speed.
- To set the shutter dial to a position other than [A], turn the shutter dial while holding down the shutter dial lock button.
 - [M] appears on the LCD panel to indicate that the Metered Manual Mode is set.

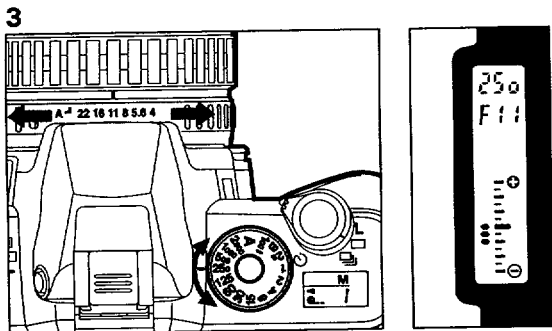

3. Turn either the shutter dial or lens aperturing until the dot is displayed in the center of the bar graph.

- When the shutter release button is depressed halfway, the shutter speed, approximate aperture and bar graph will be displayed in the viewfinder.
- When lenses other than an F or FA lens is used, no approximate aperture indication will appear in the viewfinder.
- When the dots are displayed to the [⊕] side on the bar graph, it indicates overexposure and when the dots are displayed to the [⊖] side, it indicates underexposure.
- Moving one dot on the bar graph indicates 0.5 step (0.5EV). However, when under or over exposure is set beyond + 3 or - 3 steps (3EV), [⊕] or [⊖] indicator will blink.

- In the flash photography, when you use the flash sync shutter speed of 1/100 second or a non-dedicated external flash unit, set the shutter dial to the [100] (1/100 of second) position.
- When a lens with no lens information contacts is used, use either center-weighted metering or spot metering. The multi-segment metering mode cannot be used.
- When using a Pentax A f/1.2 lens with the lens aperture ring set other than the A position, the center weighted metering mode will be set instead of the multi-segment metering mode. As the exposure will come out approx.1 stop over, set the lens aperture ring to [A], or adjust the exposure deliberately approx, 1 stop under.

* Exposure Warning

If the subject is too bright or too dark, the selected shutter speed will blink in the viewfinder as a warning as shown. When the subject is too bright, choose a smaller aperture or faster shutter speed ; when it is too dark, choose a large aperture or slower shutter speed. When the shutter speed indication stops blinking, you can take a picture. If both shutter and aperture blink, it means that the exposure is out of metering range, unable to obtain a correct exposure even if the aperture is adjusted. Select a darker subject or use a flash if it is too dark.

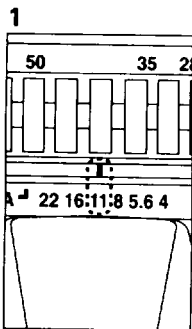

Bulb Exposure Mode

Purpose

This mode is useful for the long exposures required for shooting night scenes and fireworks. The shutter remains open as long as the shutter release button is held down.

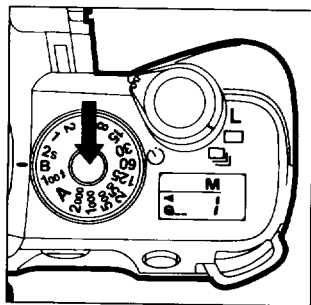
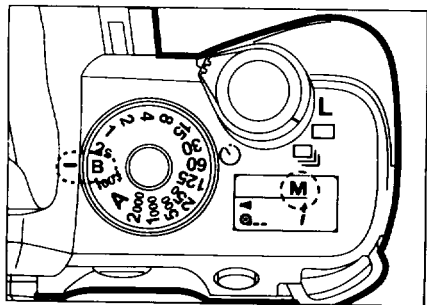

How to set

1. Set the lens aperture ring to the desired f-stop other than [A].
 2. Set the shutter dial to [B].
- Set the shutter dial to the [B] position. Turn the shutter dial while holding down the shutter dial lock button.
 - [M] appears on the LCD panel and [bu] is displayed in the viewfinder to indicate that the Bulb Exposure Mode is set.

3

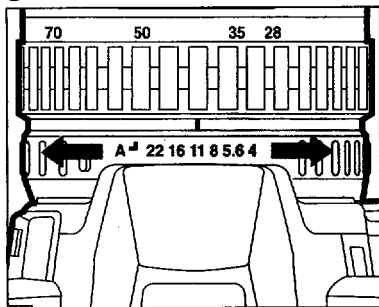

3. Adjust the desired aperture by the lens aperture ring.

- When using this mode, use a steady tripod to prevent camera shake and attach the optional "Cable Switch F" after removing the Release Socket Cap F.
- Up to approx. 8 hours of time exposure are possible with a new lithium battery at room temperatures.

61 (5) ABOUT EXPOSURE COMPENSATION

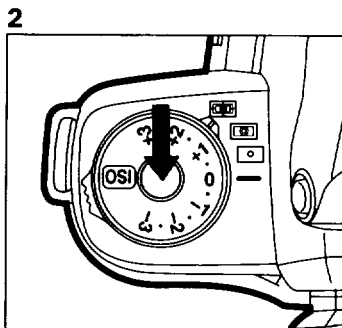
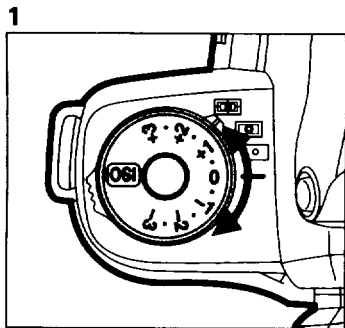

Purpose

The exposure compensation allows you to deliberately overexposure (brighten) or underexposure (darken) a subject, or compensate for difficult lighting conditions which may fool the camera's built-in exposure meter.

How to set

1. While holding down the exposure compensation dial lock button, turn the exposure compensation dial to the desired compensation value.
2. To set the exposure compensation dial to a position other than the [0] position, turn the exposure compensation dial while holding down the exposure compensation dial lock button.
3. The bar graph which indicates the compensation value and [] appear in the viewfinder.

- Exposure compensation does not work in the Bulb Exposure Mode.
- The exposure compensation range is -3EV to +3EV in 0.5EV steps.
- Moving one dot on the bar graph indicates 0.5EV step.
- When exposure compensation is used in the Metered Manual Mode, the dots on the bar graph indicates under or overexposure, it is not indicating the exposure compensation value.

(6) SPOT AF MODE

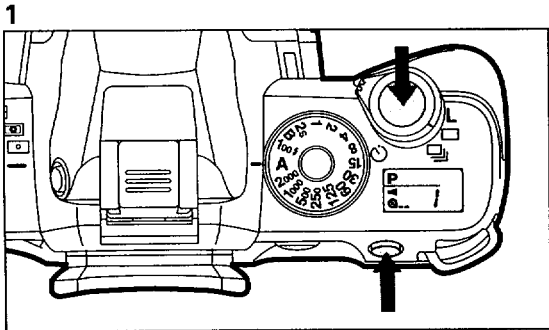

Select the Spot AF Mode to critically focus on a specific spot of the subject which is in the spot AF autofocus frame.

How to focus

1. Hold down the Spot AF button.

2



2. While holding down the Spot AF button, focus on the main subject with the Spot AF frame indicating in red in the illustration. When the shutter release button is depressed halfway down, the lens automatically focuses.
- When the main subject is off the Spot AF frame, use the focus-lock technique. See page 66.

1

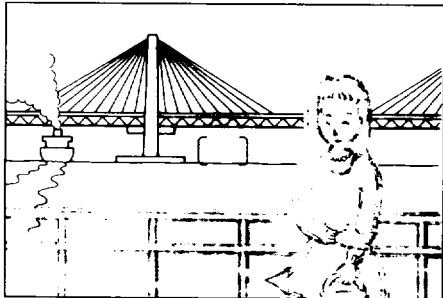

FOCUS LOCK FUNCTION

In the Spot AF mode, the camera focuses with the Spot AF frame in the center of the viewfinder.

If you shoot without positioning the Spot AF frame on the main subject, the main subject will not be focused properly.

How to use

1. When the composition does not allow the Spot AF frame to be placed over the most important subject, the camera will focus on the background as shown in the illustration.

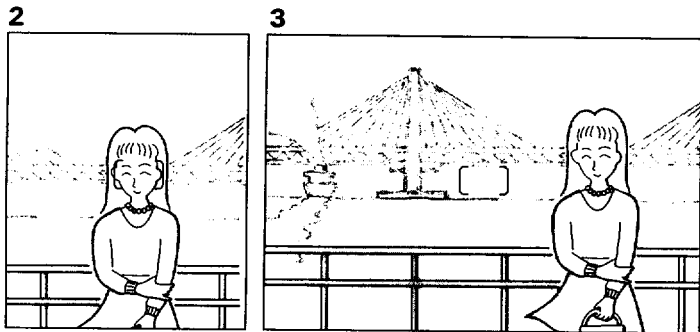

2. To prevent this, center the Spot AF frame [] on the main subject. While depressing the Spot AF button, depress and hold the shutter release button halfway down. The in-focus indicator remains on, indicating that the focus is temporarily locked.

3. While holding the shutter release button halfway down, re-aim the camera or recompose the picture, then depress the shutter release button all the way to release the shutter.

- Lifting your finger off the shutter release button clears the in-focus indicator [] in the viewfinder and cancels the focus lock function.
- To refocus on another subject, lift your finger off the shutter release button.

(7) SWITCHING THE METERING MODE

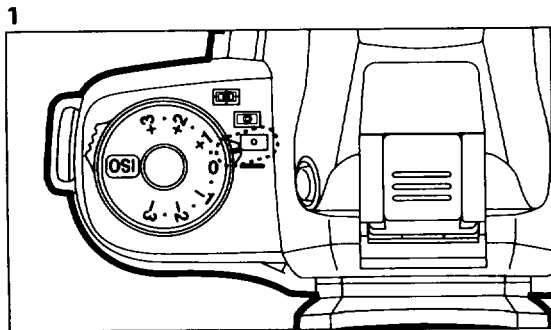

The desired metering mode, multi(6)-segment metering, spot or center weighted metering mode can be selected.

Using the Spot Metering Mode

The Spot Metering Mode measures light only in the small area in the center of the viewfinder. When shooting by using this metering mode, place the subject you want to meter within the Spot AF frame [] in the center of the viewfinder.

How to use

1. Set the metering mode switch to the [] position.

2

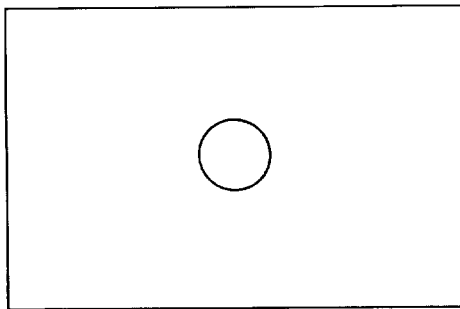

2. Measure the small area in the center of the viewfinder as illustrated.

- If the brightness range between areas in the photograph is too great, the exposure should be determined in consideration of the overall brightness. Otherwise, the picture will come out improperly exposed.

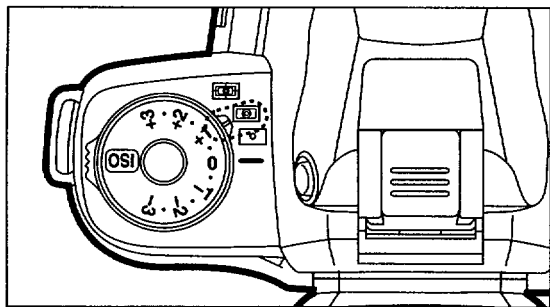

Using the Center-Weighted Metering Mode

This metering system does not automatically compensate backlit like the multi(6)-segment metering mode. The creative exposure will be decided by your adjustment.

How to use

Set the metering mode switch to the [(•)] position.

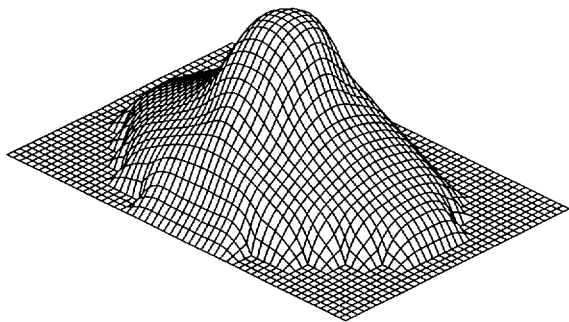

- The metering pattern in the illustration above shows the higher part of the pattern (in the center of the viewfinder) has more sensitive to light than the lower part.
- In this metering mode, the camera does not automatically compensate the exposure in backlit situations like the multi(6)-segment metering mode. The creative exposure will be decided by your adjustment.

(8) TURNING OFF THE AUDIBLE PCV SIGNAL

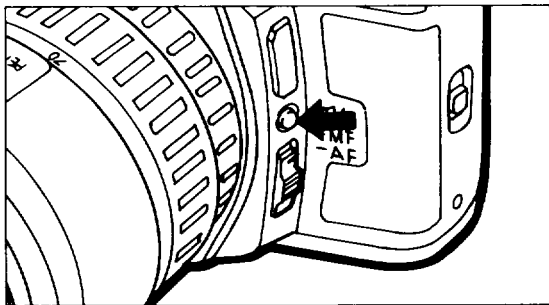

The audible In-focus PCV signal can be turned off.

How to cancel

1. Depress the multi-function button to erase [] from the LCD panel.

- Change the PCV Signal Mode only when the built-in flash is retracted. If the PCV Signal Mode is switched with the built-in flash popped up, the flash mode will be changed.
- To turn the audible PCV signal back on, depress the multi-function button to make [] appear on the LCD panel.

Programmed AE Mode

- The camera automatically chooses an optimum combination of shutter speed and aperture according to the subject brightness, allowing you to take a flash photograph with ease.
- The shutter speed automatically changes to 1/100 sec. to a slower speed which does not cause camera shake. The slowest shutter speed depends on the focal length of the lens fitted to the camera. When a non-AF lens is used, the camera uses the shutter speed of 1/100 second.

Shutter-Priority AE Mode

- The shutter speed slower than 1/100 of second can be set.
- In this mode, the aperture automatically changes according to the ambient brightness, making flash photography easy.

Aperture-Priority AE Mode

In this mode, the shutter speed automatically changes with the ambient brightness, making flash photography easy. The shutter speed changes in the range from 1/100 sec. to a slower shutter speed which does not cause camera shake. The slowest shutter speed depends on the focal length of the lens in use. The shutter speed of 1/100 sec. is automatically set when a non-autofocus lens is in use.

Metered Manual Mode

- When using the built-in flash in the Metered Manual Mode, any combination of aperture and shutter speed slower than 1/100 can be set. In this mode, the exposure of the background can be controlled by the manual exposure while the flash properly exposes the foreground/subject.

Calculating the flash effective distance according to the camera-to-subject distance.

Maximum flash distance = Guide Number \div Selected aperture

Minimum flash distance = Maximum flash distance \div 5 *

When the distance to the subject is less than 0.7m (2.3ft), the flash cannot be used. If the flash is used within that distance, it causes vignetting in the picture corners, light is distributed unevenly and the picture may be overexposed.

- The value 5 used in the formula above was obtained from the built-in flash.

The guide number (GN) depends upon the film speed used as shown below.

ISO25 \rightarrow GN5.5	ISO200 \rightarrow GN15.6
ISO50 \rightarrow GN7.8	ISO400 \rightarrow GN22
ISO100 \rightarrow GN11	

If an ISO100 film is used at an aperture of f2.8, the flash effective distance is obtained as follows:

$$\text{Guide Number (11)} \div f/2.8 = 3.9\text{m}$$

$$3.9 \div 5 = 0.8\text{m}$$

Thus, the flash effective distance is from approx. 0.8m to 3.9m.

Calculating the aperture according to the camera-to-subject distance

Aperture = Guide Number \div Camera-to-subject distance

If the calculated aperture value is different than an indicated f-stop on the aperture ring, for instance f/3, choose the next smallest aperture ring (f2.8 in this case).

Calculating the camera-to-subject distance in the Shutter-Priority AE Mode.

The camera-to-subject distance can be calculated using the above mentioned formula. However, in the Shutter-Priority AE Mode, the-camera-to-subject distance will change depending on what aperture is set.

COMPATIBILITY OF F AND FA LENSES WITH THE BUILT-IN FLASH

[○ = compatible × = incompatible because of vignetting]

Lens name	Compatibility
F Fish-Eye Zoom 17-28mm f/3.5-4.5	×
F Zoom 24-50mm f/4	△ * 1
FA Zoom 28-70mm f/4	○
FA*Zoom 28-70mm f/2.8	×
FA Zoom 28-80mm f/3.5-4.7	○
F Zoom 28-80mm f/3.5-4.5	△ * 2
FA Zoom 28-105mm f/4-5.6	△ * 3
F Zoom 35-70mm f/3.5-4.5	○
F Zoom 35-80mm f/4-5.6	○
F Zoom 35-105mm f/4-5.6	○
F Zoom 35-135mm f/3.5-4.5	○
FA Zoom 70-200mm f/4-5.6	○
F Zoom 70-210mm f/4-5.6	○
FA*Zoom 80-200mm f/2.8	△ * 4
F Zoom 80-200mm f/4.7-5.6	○
F Zoom 100-300mm f/4.5-5.6	○
FA Zoom 100-300mm f/4.5-5.6	○
F or FA* Zoom 250-600mm f/5.6	×

* 1 : Focal lengths between 28-50mm lens, vignetting will not occur. Vignetting will occur at focal lengths between 24-35mm.

* 2 : Vignetting will occur at focal lengths between 28-35mm.

* 3 : Vignetting will occur at focal lengths between 28-35mm. With the focal length set at 35mm, it will occur when the camera-to-subject distance is closer than 1.5m.

* 4 : Vignetting will occur at focal lengths between 80-90mm.

Lens name	Compatibility
FA20mm f/2.8	×
FA*24mm f/2	×
F or FA 28mm f/2.8	○
F or FA 50mm f/1.4	○
F or FA 50mm f/1.7	○
FA*85mm f/1.4	○
F or FA 135mm f/2.8	○
FA*200mm f/2.8	○
FA*300mm f/2.8	×
F or FA*300mm f/4.5	×
F or FA*600mm f/4	×
F or FA MACRO 50mm f/2.8	○
F or FA MACRO 100mm f/2.8	○
F or FA Soft 85mm f/2.8	○

(10) SETTING THE FILM SPEED (ISO) MANUALLY

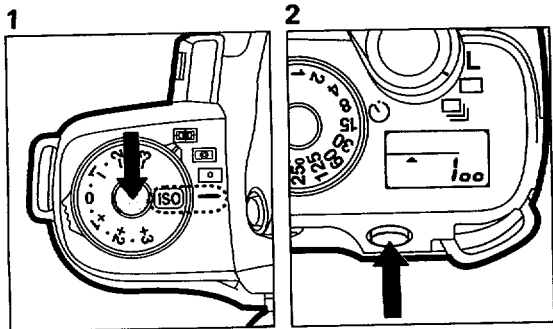

This camera automatically reads the film speed from the film's DX code. However, the film speed setting can be changed. If you use a non-DX coding film, set the film speed manually.

How to set

1. While holding down the exposure compensation dial lock button, set the exposure compensation dial to [ISO].
2. To change the ISO to a larger number (higher film speed), hold down the AF Spot button until the desired ISO is indicated on the LCD panel.

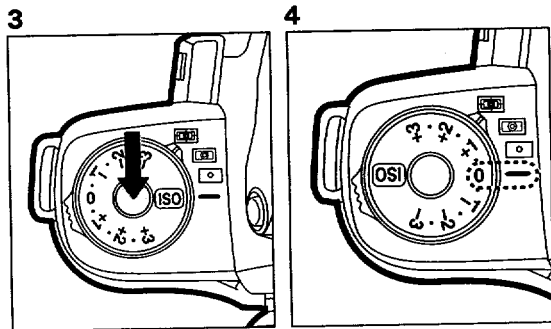

3. To change the film speed to a smaller number (lower film speed), hold down the Spot AF button while holding down the exposure compensation lock button.
 4. After the ISO is set, move the exposure compensation dial to [0].
- When exposure compensation dial is set to [ISO], [▲] is displayed on the LCD panel to indicate that the ISO can be changed to a large number. When the exposure compensation dial lock button is depressed, [▼] appears on the LCD panel to indicate that the ISO can be changed to a smaller number.
 - The shutter cannot be released with the exposure compensation dial set at [ISO].

(11) USING A PENTAX DEDICATED EXTERNAL FLASH

If the built-in flash is not powerful enough, a Pentax dedicated external flash should be used.

An external TTL Auto Flash like the PENTAX AF FTZ or AF FT series flash units (ie: AF500FTZ, AF330FTZ or the AF240FT) incorporate the TTL Flash Mode.

1. Remove the hot shoe cover F_c and attach a Pentax dedicated flash unit.
 2. Turn ON the flash.
 3. Set the flash unit to the TTL Auto Mode.
 4. Ensure that the flash is fully charged.
 5. Proceed as if the built-in flash were being used.
- When the flash is fully charged, the ready lamp on the flash unit lights up. When the shutter release button is depressed halfway down, [] appears in the viewfinder indicating the flash is ready.
 - Using the dedicated external flash in each exposure mode is the same as using the built-in flash, see page 71.

Using the built-in flash and the external flash simultaneously

An external flash cannot be attached when the built-in flash is popped up position. When the built-in flash and the external flash are used simultaneously, use the following optional accessories.

- Hot Shoe Adapter F_c
To be attached to the hot shoe of the camera.
- Off-Camera Shoe Adapter F
The Off-Camera Shoe Adapter F can be mounted on a tripod with the built-in tripod socket.
- Extension Cord F5P (L)
Connection cord for the Hot Shoe Adapter F_c and Off-Camera Shoe Adapter.

AF500FTZ and AF330FTZ

- These flash units feature a built-in infrared spotbeam to assist the autofocus system in dim light and low-contrast conditions.
- The auto zoom function will automatically adjust the angle of discharge according to the lens focal length only when an F or FA lens is in use.
- The AF500FTZ features a wireless slave-sync flash function.
- The flash effective range appears on the LCD panel only when an A, F, or FA lens is in use.
- Multiple flash burst on a single frame is possible with the AF500FTZ.
- These flash units feature the contrast-control-synch flash. See page 78 for more details.
- In the Programmed AE, Shutter-Priority AE, or Aperture-Priority AE, the TTL Auto Flash Mode will be set automatically even if the flash is set to Manual.
- When the flash is charged and left unused for about 3 minutes, the power automatically switches off to save battery power. Depressing the shutter release button halfway down will restart charging of the flash units.

AF240FT, AF400FTZ

- These flash units feature a built-in infrared spotbeam to assist the autofocus system in dim light and low-contrast conditions.
- In the Programmed AE, Shutter-Priority AE, or Aperture-Priority AE: TTL Auto Flash Mode will be set automatically even if the flash unit is set to Manual.
- When the flash unit is charged and left unused for about 5 minutes, the power will automatically switch off to save battery power. Depressing the shutter release button halfway down will restart charging of the flash unit.

AF200T, AF280T, and AF400T

- If the TTL auto mode is selected, these flash units can be used for daylight-sync shooting, because the shutter speed is adjusted according to the ambient brightness. The slower shutter speed varies according to the lens focal length. The shutter speed varies within the shutter speed range of 1/100 of second to a slower speed which does not cause camera shake. However, when a non-autofocus lens is in use, the shutter speed is set to 1/100 of second. The aperture value will also be fixed but will vary depending on what ISO film is loaded.

- When using the Three-Level Auto (red, green, and yellow settings) mode, the aperture value is adjusted as shown in the table. When the flash is fully charged, the shutter speed also varies within the shutter speed range of 1/100 to a slower speed which does not cause camera shake. The slowest shutter speed varies according to the lens focal length. When a non-autofocus lens is in use, the shutter speed will be set to 1/100 of second.

	AF200T	AF280T	AF400T
Red	f/2.8	f/4	f/4
Green	f/5.6	f/8	f/8
Yellow			f/11

with ISO100

Notes on Pentax dedicated flash units

When the built-in flash is used in combination with a Pentax dedicated flash unit, if the trailing-shutter-curtain sync mode is set for the dedicated flash unit, the built-in flash also operates in the trailing-shutter curtain sync. mode. Ensure that both flash units are fully charged before releasing the shutter.

Contrast-Control-Sync Flash Photography

Using the AF330FTZ or AF500FTZ in combination with the built-in flash allows twin flash photography (contrast-control-sync flash photography). This is based on the difference between the amount of light discharged from two units.

1. Put the AF500FTZ or AF330FTZ in the Contrast-Control Sync Flash Mode.
 2. Ensure that both flash units are fully charged and then shoot.
- The ratio of the amount of flash light is 1 (built-in flash) : 2 (dedicated flash unit). When the AF500FTZ or AF330FTZ is used off the camera, the effect of contrast control is increased. Do not combine an accessory with a different number of contacts such as a "Hot Shoe Grip" as a malfunction may occur.
 - In the Contrast-Control-Sync Flash Mode, the top flash sync speed is 1/60 of second.

Multi-burst flash with the Pentax dedicated flash

When discharging more than 2 Pentax dedicated flashes, make sure that they are of the same type, combine the Type B with Type C or Type D with Type E. (refer to the overview of Flash Function on page 79. The Built-In flash can be operated with any type of Pentax TTL dedicated flash unit.

Overview of Flash Function

CAMERA FUNCTION	TYPE A	TYPE B	TYPE C	TYPE D	TYPE E
After the flash is charged, the camera automatically switches to the flash-sync speed.	○	○	○	○	○
Automatic aperture setting in the Programmed AE Mode or Shutter-Priority AE mode.	○	○	○	○*1	○*1
Flash confirmation signal in the viewfinder		○	○		
TTL auto flash	○	○	○	○*2	
Slow-speed sync in the Shutter-Priority AE Mode or Metered Manual Mode	○	○	○	○	○*3
AF spotbeam		○	○		
Trailing-shutter-curtain flash sync (*4)	*5	○	○		
Contrast-control-sync flash mode (*4)		○			

TYPE A : Built-in flash

TYPE B : AF500FTZ (*6), AF330FTZ

TYPE C : AF400FTZ, AF240FT

TYPE D : AF400T, AF280T, AF200T, AF080C,
AF140C, AF200SA

TYPE E : AF200S, AF160, AF140,

Notes:

- * 1. When using a Type D flash except AF200SA in the MS (Manual Synch) or M (Manual) modes or when using a Type E flash, set the camera's exposure mode to the Aperture-Priority AE Mode, Manual or Bulb. The Program and Aperture-Priority AE Modes cannot be used because the actual required aperture value may change.

* 2. Only the AF200SA flash does not operate.

* 3. Only the manual mode can be used.

* 4. The shutter speed is 1/60 or slower.

* 5. Trailing-shutter-curtain flash sync combined with TYPE B or TYPE C flash.

* 6. Multi-burst and slave-sync flash are possible.

Using other type of a flash

Use of non-Pentax flash units may damage the camera. For the best results, use the Pentax dedicated flash unit.

(12) DAYLIGHT-SYNC SHOOTING



Without Daylight-Sync



With Daylight-Sync

Purpose

In daylight conditions, when a portrait picture is taken with a person's face in shadow, discharging the flash will eliminate the shadow.

Daylight-sync photography is obtained in the same manner as the normal flash photography, so you simply depress the shutter release button.

- If the background is too bright, it may be overexposed.
- When taking a daylight-sync photograph in the Programmed AE Mode, the flash does not discharge if the automatic flash function is activated even if the flash is in the popped-up position. Before shooting, confirm that  is not displayed on the LCD panel.

(13) SLOW-SPEED-SYNC SHOOTING



Purpose

It is possible to balance the exposure of a foreground subject against a dimly-lit background by using the flash to properly expose the foreground subject and a slow-shutter-speed to expose the low light background.

How to set

With the Metered Manual Mode set

1. Depress the flash pop-up button to activate the built-in flash.
2. Set the camera's exposure mode to the Metered Manual Mode.
3. Select an appropriate shutter speed (slower than $1/100$ of second) and aperture combination for a correct exposure.
4. Release the shutter.

How to set

With the Shutter-Priority AE Mode set

1. Set the camera's exposure mode to the Shutter-Priority AE Mode.
 2. Set the desired shutter speed.
- If the aperture in the viewfinder blinks, a correct exposure will not be obtained for the background. Adjust the shutter speed until the blinking stops.
3. Depress the flash-pop up button to activate the built-in flash.
 4. Take a picture.
- In the slow-speed-sync shooting, use of a tripod is recommended to prevent camera shake.

(14) ACCESSORIES (OPTION)

A number of dedicated accessories are available for this camera.

• Cable Switch F

A shutter release cord designed for use with the MZ-5/ZX-5, Z-70/PZ-70, Z-20/PZ-20, Z-10/PZ-10, Z-1/PZ-1, Z-1_P/PZ-1_P.

• Magnifier FB

A viewfinder accessory for magnifying the central area of the viewfinder.

• AF500FTZ

A TTL Auto Zoom flash with a built-in AF spotbeam and large guide number of 50 in meters (ISO100). It features slave sync flash function, multiple flash burst, contrast-control-sync flash, leading/trailing-curtain-sync flash mode.

• AF330FTZ

A TTL Auto Zoom flash with a built-in AF spotbeam and guide number of 33 in meters (ISO100). It features contrast-control flash, leading/trailing-curtain-sync flash mode.

• Hot Shoe Adapter F_o, Extension Cord F5P(L) and Off-Camera-Shoe Adapter.

The adapters and cord which allow the AF240FT, AF330FTZ, AF400FTZ and AF500FTZ to be used off the camera, while maintaining full electronic coupling to the camera.

• AF Adapter 1.7X

An adapter for autofocus photography using KA- or K-mount lenses with a maximum aperture of f/2.8 or larger.

• Macro Flash AF140C

A TTL macro flash unit with the guide numbers 14 in meters (ISO100).

• Refconverter A

Right angle finder which attaches to the grooves on both sides of the viewfinder. The viewfinder magnification is able to switch from 1X to 2X.

• Filters

Skylight, Cloudy, UV, Y2, O2, R2, and Circular Polarizing Filter are available. Each filter is available in sizes of 49mm, 52mm, 67mm and 77mm.

• AA-Battery Pack F_o

The battery pack which takes four AA batteries can attach at the bottom of the camera, instead of using the lithium batteries.

• Data Back F_o

Allowing you to print one of the following data modes on the film both standard format mode and panoramic format mode.

year/month/day, day/month/year, month/day
/year, day/hour/minute,(blank)

Notes on Accessories

- "Auto Bellows A" cannot be used in combination with the double cable release. When taking a vertical photograph, position the camera with the grip facing upward.
- When attaching the "ADAPTER K FOR 645 LENS" to the camera body, the camera shift lock screw of the lens may hit the camera body. To avoid this, change the position of the fixing screw.



(15) CAMERA CASE

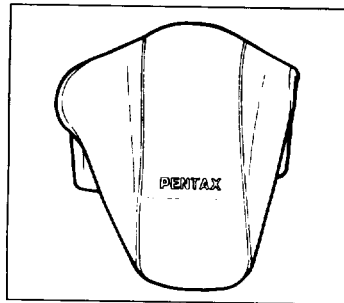
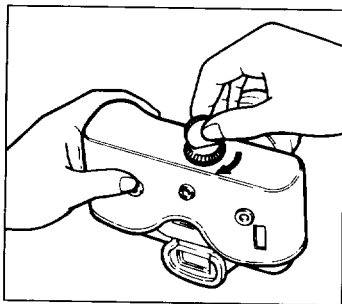
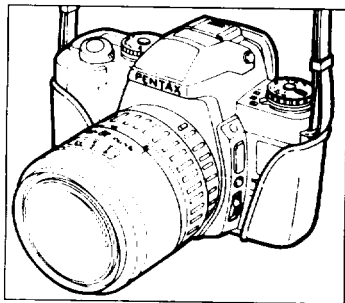

The soft case is available as an option and consists of a front and a back cover.

- 1 Open the front cover and place the camera body in the back cover.
- 2 Fasten the back cover to the camera body by tightening the fitting screw in the tripod socket.
- 3 Attach the front case.

- Choose one of the front cases in accordance with the table to the right.
- The back case F_c is the same back case indicated with the Soft case S, M and L.

Front case comes in three sizes, S, M and L

Case	Applicable F, FA-lens
F_cS	20mm, 28mm, 50mm f/1.4, f/1.7, Fish-Eye Zoom 17-28mm, Zoom 35-80mm
F_cM	24mm, Macro 50mm, 135mm, Zoom 28-70mm f/4, Zoom 28-80mm, Soft 85mm
F_cL	85mm f/1.4, Macro 100mm, Zoom 28-105mm, Zoom 70-200mm, F Zoom 80-200mm

(16) EFFECT OF APERTURE AND SHUTTER SPEED

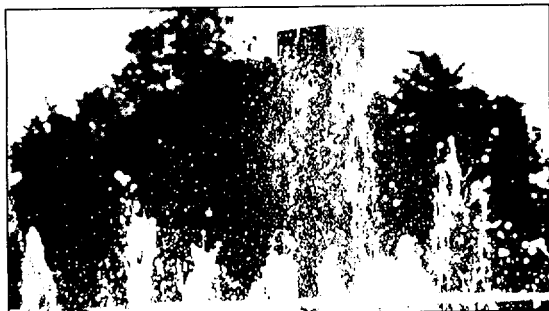

High shutter speed



Slow shutter speed

A correct exposure is established by a combination of shutter speed and aperture setting according to the subject brightness. There are many correct combinations of shutter speed and aperture for a particular subject brightness. Different shutter speed and aperture settings produce different effects.

Effect of Shutter Speed

The shutter speed determines the film exposure time, or the length of time that light is allowed to strike the film. If the subject is moving the image will be blurred when a slow shutter speed is used. It is possible to enhance the effect of motion, (The movement of a wave or waterfall) by intentionally using a slower speed. Choosing a high shutter speed will allow the image of a moving subject to be frozen. A higher shutter speed also helps prevent camera shake.



Closed-down aperture



Open aperture

Effect of Aperture

The aperture increases or reduces the amount of reflected light from an object which passes through the lens, controlling how much light strikes the film. If the aperture is opened up to increase the amount of light, objects in front of and behind an in-focus subject will not be focused. That is, the range of focus (depth of field) becomes small. If the aperture is closed down to reduce the amount of light, the depth of field increases. For instance, if you shoot a person against a landscape with the aperture open, the landscape in front of and behind the person will be blurred, making the person appear to rise out of the landscape. By contrast, closing down the aperture increases the in-focus range.

(17) DEPTH OF FIELD

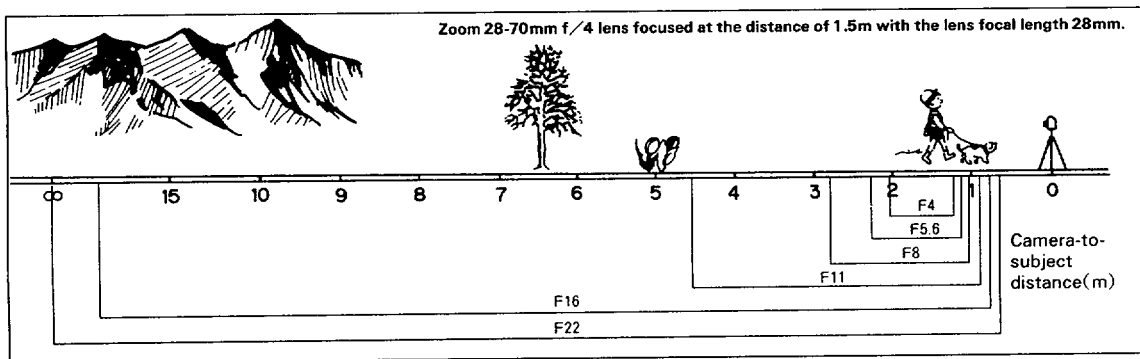

Depth of field refers to the range around the optimum focusing point of the subject in which the elements at different distances are in focus. The depth of field increases as the aperture is closed down, the focal length of the lens becomes shorter, or the subject is positioned farther away.

The Range Allowed for Focusing

The in-focus range varies depending on the aperture in use. Zoom lenses do not have a depth-of-field scale for mechanical considerations.

(18) INFRARED INDEX

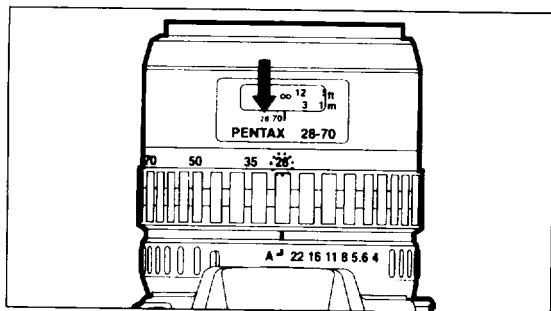

When infrared film and an "R2" or "O2" filter are used, the focal point is different from that of ordinary film exposed in visible light. The autofocus system cannot compensate for this difference automatically.

1. Focus on a subject as usual.
2. Set the focus mode switch to **[MF]** and turn the focusing ring to the left by the distance indicated on the infrared index.

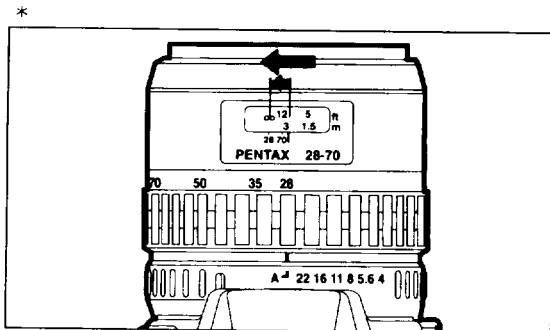

* As shown in the illustration, if 28 is read from the zoom scale, adjust the distance scale to 28 on the infrared index (red line).

- In the autofocus mode, the focus cannot compensate for infrared photography.
- To set the proper exposure level for infrared pictures, refer to the instructions accompanying the film. The Programmed AE Mode does not give a correct exposure. Use the Metered Manual Mode.

IV OTHERS











TROUBLESHOOTING

What appears troublesome may be easily remedied. Here are some problems that may occur and their remedies. Before contacting a Pentax service center, check the following items.

Symptoms	Causes	Remedies	Reference
The shutter does not release.	The drive mode switch is set to [L].	Turn ON the drive mode switch.	P.21
	The low battery warning [] appears.	Replace the battery.	P.14
	The battery is improperly installed.	Install the battery properly.	P.14
	The exposure compensation dial is set to ISO.	Set the exposure compensation dial to the another position.	P.75
	The self-timer mode is being set.	Cancel the self-timer mode.	P.45
	The built-in flash is being charged.	Wait until the flash is fully charged.	P.38
Indicators do not appear on the LCD panel.	The drive mode switch is [L].	Turn ON the drive mode switch.	P.21
	No battery has been installed.	Install the battery.	P.14
	The battery is improperly installed.	Install the battery properly.	P.14
	The battery is dead.	Replace the battery.	P.14
The camera does not focus.	AF frame is not placed over the subject.	Move the camera until the AF frame [] covers the subject.	P.36
	The subject is too close.	Increase the camera-to-subject distance.	P.36
	The focus mode is set to [MF].	Set the focus mode switch to [AF].	P.35
	The subject is difficult to autofocus.	Use the focus-lock technique or focus manually using the matte field.	P.66 P.47

Symptoms	Causes	Remedies	Reference
[] blinks in the viewfinder.	The subject is too close or difficult to autofocus.	Use the focus-lock technique or focus manually using the matte field.	P.66 P.47
The built-in flash does not charge.	The battery is dead.	Replace the battery.	P.14
The power zoom system does not function.	The lens is in the manual zoom mode.	Push the power zoom ring forward until the words [POWER ZOOM] appear.	P.33
The lens focuses when zooming.	The camera focuses automatically when the power zoom is operated.		

SPECIFICATIONS

Type:	TTL autofocus, auto-exposure 35mm SLR with built-in TTL auto flash (RTF)
Format:	24x36mm (Approx. 13x36 in panoramic format)
Usable Film:	35mm perforated cartridge film. DX-coded film with ISO 25-5000; non-DX coded films with ISO 6-6400
Exposure Mode:	Programmed AE Mode, Shutter-Priority AE Mode, Aperture-Priority AE Mode, Metered Manual Mode, Bulb Mode
Shutter:	Electronically controlled vertical-run focal-plane shutter, Electromagnetic release, Speed range:(1)Auto 1/2000-30 sec.(steplless),(2)Manual 1/2000-2 sec.(3)Bulb, Shutter lock by setting Drive mode switch at L.
Lens Mount:	Pentax K _{AF2} bayonet mount(K-mount with AF coupler, lens information contacts and power contacts)
Compatible Lens:	Pentax K _{AF2} -, K _{AF} -, K _A -, and K-mount lenses are usable. Autofocus is possible using AF Adapter with K-K _A -mount lenses.
Autofocus System:	TTL phase-matching 3 point autofocus system switchable to Spot focusing, AF operational brightness range: EV-1 to 18(at ISO 100 with f/1.4 lens), Focus lock available using shutter release button, Focus Mode: AF(predictive AF provided), Manual[MF]
Power Zoom:	3-Speed Intelligent Power Zoom lens with built-in motor with FA zoom lens
Viewfinder:	Pentaprism finder, Natural-Bright-Matte focusing screen, Field of view:92%, Magnification:0.80X(with 50mm lens at ∞), Diopter: -2.5 to +1.5 diopters, Panorama format frame
Viewfinder Indication:	Focus Information:In-focus (Green lamp [] is lit), front or back focus signals and unable-to-focus indicator (Green lamp blinks), Shutter speed indication, Aperture indication, Flash ready indication [] is lit, Bar graph(exposure compensation),Over or Under exposure indication in Manual Exposure Mode, [] exposure compensation indication
External LCD panel Indication:	[P] = Programmed-AE Mode, [Tv] = Shutter-Priority AE Mode, [Av] = Aperture-Priority AE Mode, [M] = Metered Manual Mode, [bu] = Bulb-Mode, Film speed = 6 - 6400, ISO indication, [] = Film status information, [] = Battery exhaustion warning, Film counter = 0-99 [] = Built-in flash ready indication [] = blinking slowly flash recommended warning [] = blinks rapidly Inappropriate lens warning, [] = Red-eye reduction flash mode [] = Automatic flash function, [] = PCV signal indication

- Self-timer :** Electronically-controlled type with delay time of 12 sec. Start by depressing of shutter release button, Operation confirmation: By audible PCV signals. Cancelable after operation
- Mirror :** Instant-return mirror with AF secondary mirror
- Film Loading:** Film advances automatically to 1st frame after back cover is closed, Film information window is provided
- Film Wind & Rewind:** Auto wind/rewind by built-in motor, Consecutive or Single advance mode, Approx.2.0 frames/sec.(consecutive mode), Auto rewinding starts at end of roll, Film rewind/completion of rewinding is displayed on the LCD panel, mid-roll rewind button will rewind film in mid-roll
- Exposure Meter:** TTL multi(6)-segment metering, Metering range from EV0 to EV21 at ISO100 with 50mm f/1.4 lens, Center-weighted and Spot metering mode can be set
- Exposure Compensation:** + / - 3EV in 0.5EV step increments
- Flash :** Series-control, Retractable TTL Auto Flash (RTF), Guide number:11 (ISO100/m), Illumination angle covers 28mm lens angle of view, Flash-sync-speed in the range from 1/100 to a slower speed, Day-light-sync flash, Slow-speed-sync flash, Contrast-control-synch flash (ISO range=25-400), Automatic flash function, Red-eye reduction flash
- Flash sync :** Hot shoe with X-contact with coupled with Pentax dedicated auto flashes, ISO range=25-800
- Power Source:** Two 3V lithium battery (CR2 or equivalent)
- Battery Exhaustion Warning:** Battery exhaustion symbol [] is lit (blinking when the shutter is locked; no indication on the right-hand edge of the viewfinder.)
- Dimension and Weight:** 135.0mm(W)x90.0mm(H)x61.5mm(D) (5.3"x3.5"x2.4") 400g(14.1 oz) body only without batteries
- Supplied Accessories:** Hot Shoe Cover F_c, Release Socket Cap F, Camera Strap F_c, Eye Cup F_c, Finder Cap
- Back cover :** Interchangeable for replacing with Data Back F_c

SPECIFICATIONS ARE SUBJECT TO CHANGE AT ANY TIME WITHOUT NOTIFICATION OR ANY OBLIGATION ON THE PART OF THE MANUFACTURER.

WARRANTY POLICY

All Pentax cameras purchased through authorized bona fide photographic distribution channels are guaranteed against defects of material or workmanship for a period of twelve months from date of purchase. Service will be rendered, and defective parts will be replaced without cost to you within that period, provided the equipment does not show evidence of impact, sand or liquid damage, mishandling, tampering, battery or chemical corrosion, operation contrary to operating instructions, or modification by an unauthorized repair shop. The manufacturer or its authorized representatives shall not be liable for any repair or alterations except those made with its written consent and shall not be liable for damages from delay or loss of use or from other indirect or consequential damages of any kind, whether caused by defective material or workmanship or otherwise; and it is expressly agreed that the liability of the manufacturer or its representatives under all guarantees or warranties, whether expressed or implied, is strictly limited to the replacement of parts as hereinbefore provided. No refunds will be made on repairs by non-authorized Pentax service facilities.

Procedure During 12-month Warranty Period

Any Pentax which proves defective during the 12-month warranty period should be returned to the dealer from whom you purchased the equipment or to the manufacturer. If there is no representatives of the manufacturer in your country, send the equipment to the manufacturer, with postage prepaid. In this case, it will take a considerable length of time before the equipment can be returned to you owing to the complicated customs procedures required. If the equipment is covered by warranty, repairs will be made and parts replaced free of charge, and the equipment will be returned to you upon completion of servicing. If the equipment is not covered by warranty, regular charges of the manufacturer or of its representatives will apply. Shipping charges are to be borne by the owner. If your Pentax was purchased outside of the country where you wish to have it serviced during the warranty period, regular handling and servicing fees may be charged by the manufacturer's representatives in that country. Notwithstanding this, your Pentax returned to the manufacturer will be serviced free of charge according to this procedure and warranty policy.

In any case, however, shipping charges and customs clearance fees to be borne by the sender. To prove the date of your purchase when required, please keep the receipt or bills covering the purchase of your equipment for at least a year. Before sending your equipment for servicing, please make sure that you are sending it to the manufacturer's authorized representatives or their approved repair shops, unless you are sending it directly to the manufacturer. Always obtain a quotation for the service charge, and only after you accept the quoted service charge, instruct the service station to proceed with the servicing.

The local warranty policies available from Pentax distributors in some countries can supersede this warranty policy. Therefore, we recommend that you review the warranty card supplied with your product at the time of purchase, or contact the PENTAX distributor in your country for more information and to receive a copy of the warranty policy.

NAMES OF WORKING PARTS II

- ① Shutter curtain
- ② Viewfinder eyepiece
- ③ Diopter adjustment lever (p.27)
- ④ Eyecup FG (p.27)
- ⑤ Panorama lever (p.52)
- ⑥ Spot AF button (p.65)
- ⑦ Film information window
- ⑧ Pressure plate
- ⑨ Back cover
- ⑩ Film leader end mark (p.23)
- ⑪ Battery chamber cover screw (p.13)
- ⑫ Battery chamber cover (p.14)
- ⑬ Sprocket
- ⑭ Tripod socket
- ⑮ DX-information pin (p.23)
- ⑯ Film chamber

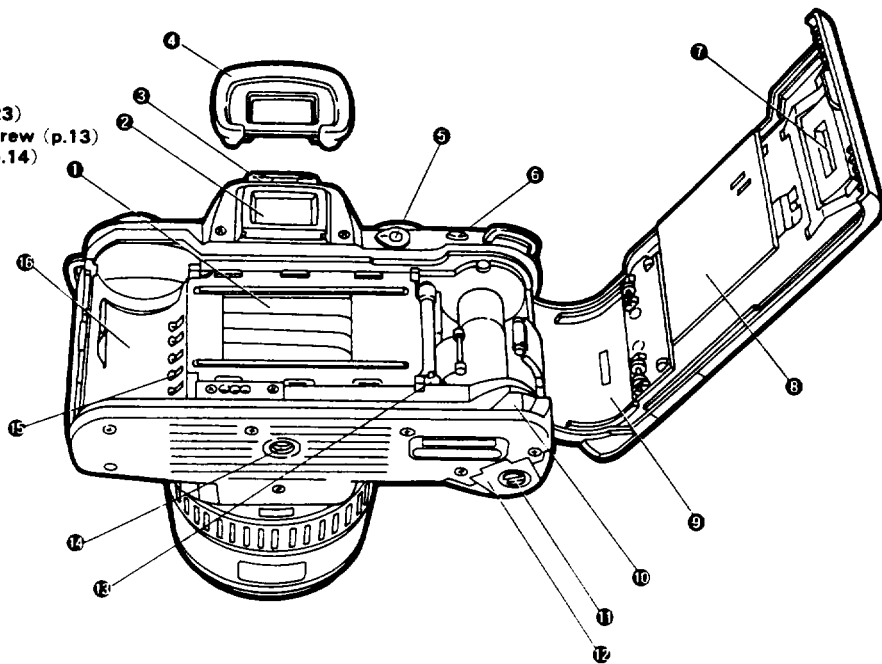



Asahi Optical Co., Ltd., 11-1, Nagata-cho 1-chome, Chiyoda-ku, Tokyo 100, JAPAN
Pentax Europe n.v., Weveldlaan 3-5, 1930 Zaventem, BELGIUM
Pentax GmbH, Julius-Vosseler-Strasse, 104, D-22527 Hamburg, GERMANY
Pentax U.K. Limited, Pentax House, Heron Drive, Langley, Slough SL3 8PN, U.K.
Pentax France S.A., Z.I. Argenteuil, 12, rue Ambroise Croizat, 95100 Argenteuil, FRANCE
Pentax Benelux B.V., (for Netherlands) Spinveld 25, 4815 HR Breda, NETHERLANDS
(for Belgium & Luxemburg) Weveldlaan 3-5, 1930 Zaventem, BELGIUM
Pentax (Schweiz) AG, Industriestrasse 2, 8305 Dietlikon, SWITZERLAND
Pentax Scandinavia AB, Falhagsleden 57, 75127 Uppsala, SWEDEN
Pentax Corporation, 35 Inverness Drive East, Englewood, Colorado 80112, U.S.A.
Pentax Canada Inc., 3131 Universal Drive, Mississauga, Ontario L4X 2E5, CANADA